

# Packing Method View

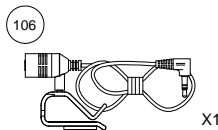

MODEL	Symbol No.	Parts No.	Description
	<a href="#">101-1</a>	03S60820Y16	SCR,MCH 5X8 ZN A
	<a href="#">101-2</a>	03S60824Y01	SCR,WEV 1.7X4 ZN A
	<a href="#">101-3</a>	07-01964Z01	BKT,RELEASE
	<a href="#">102-1</a>	68-10334Z44	O/M-CDROM BASIC
	<a href="#">102-2</a>	68-21627Z23	C/N-QRG AOAM DDA
	<a href="#">103</a>	15-01970Z01	CASE,INNER
	<a href="#">104</a>	15D01798K04	CARRYING,CASE
	<a href="#">105</a>	09-17244Z01	ASSY,ANIC-0050-01A
	<a href="#">106</a>	50-14386Z03	ASSY,LYS-M9750-FUL

# Exploded View (Cabinet) (1/2)

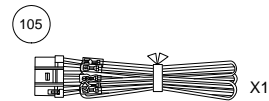
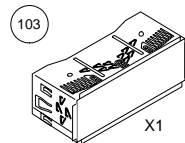
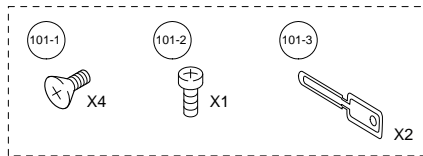
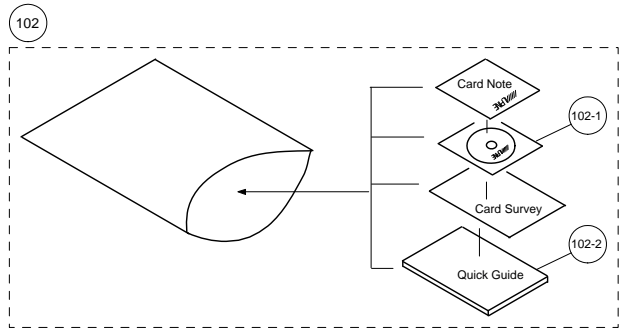
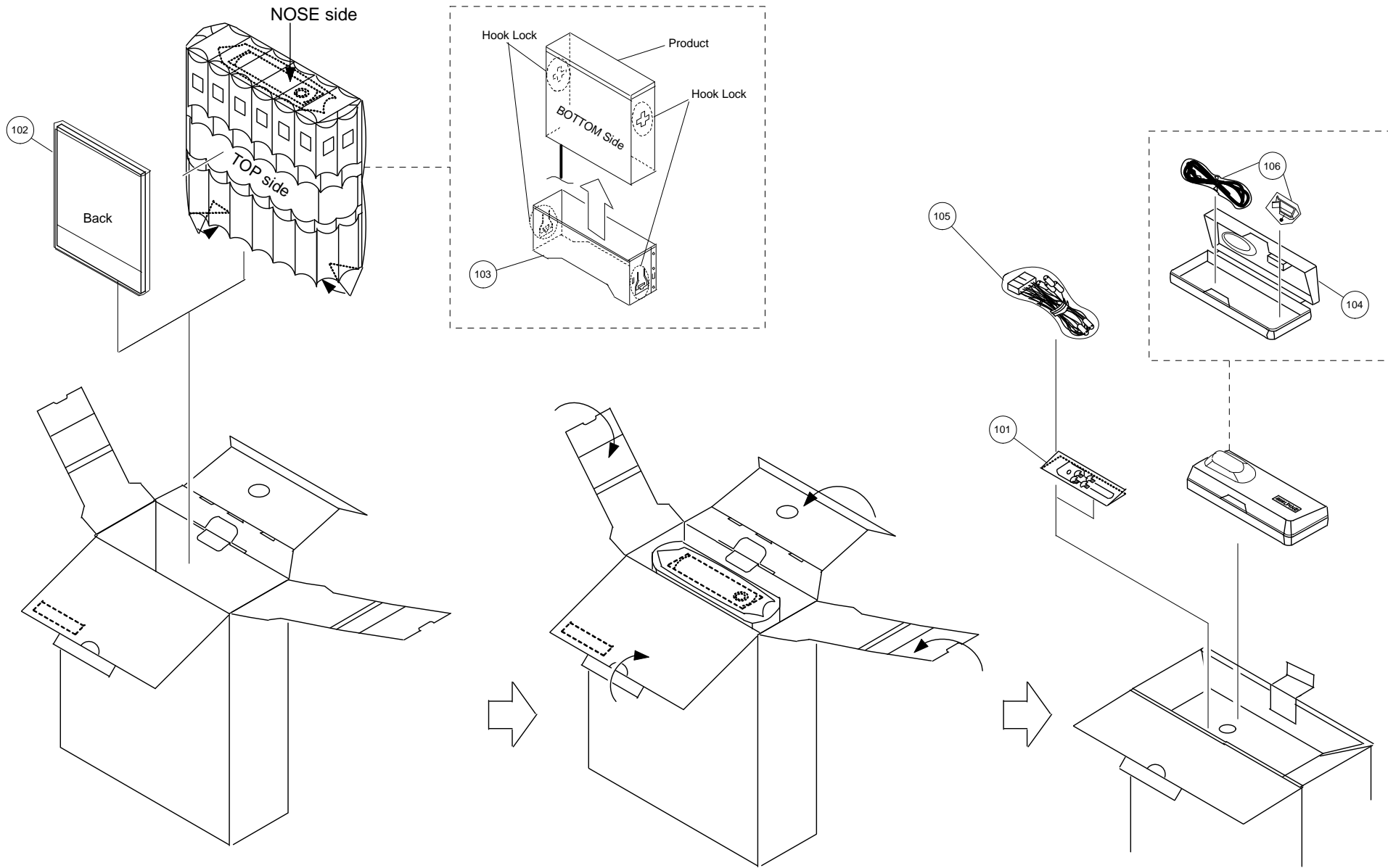
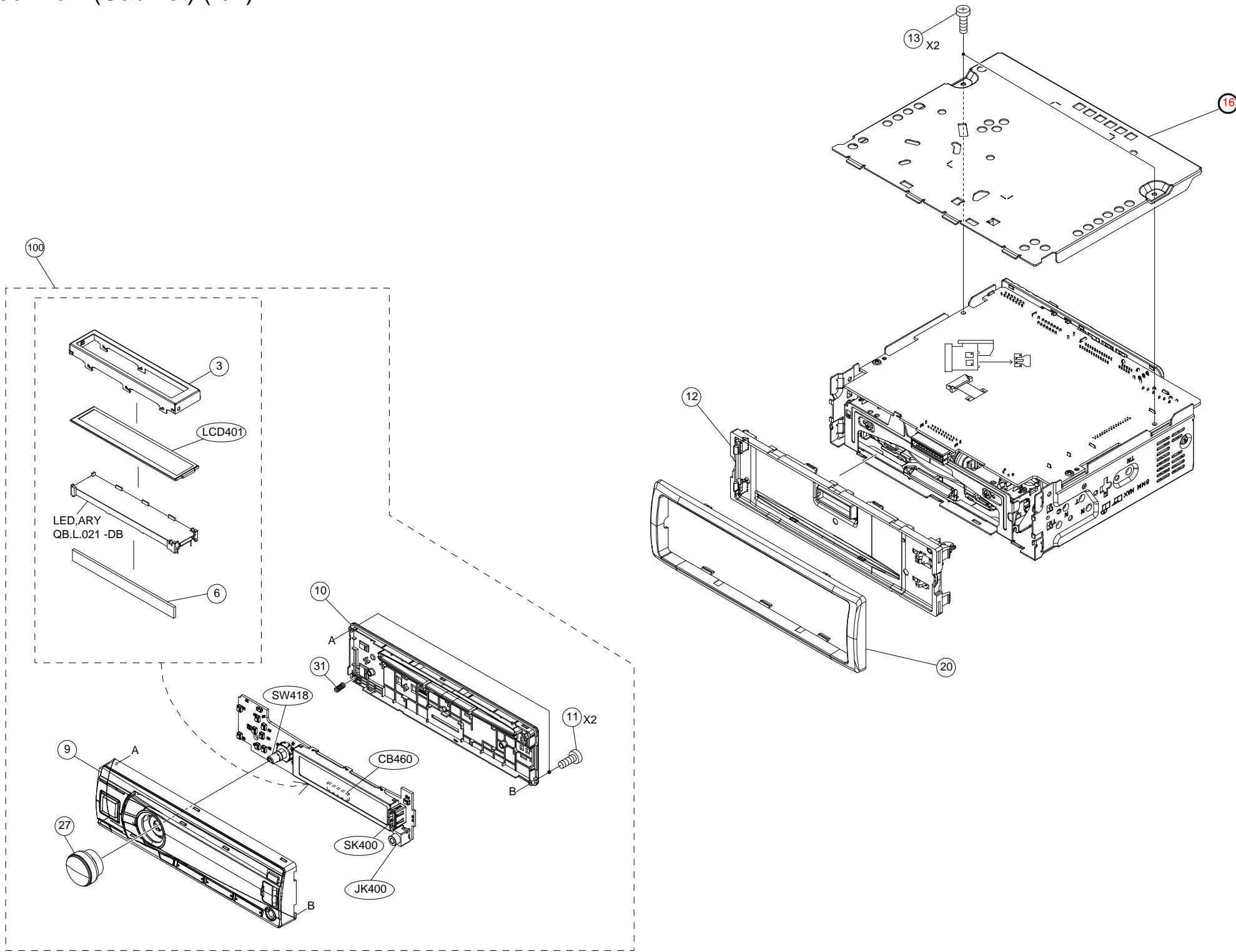



MODEL	Symbol No.	Parts No.	Description
	<a href="#">3</a>	15-18736Z01	COVER,LCD
	<a href="#">6</a>	75-19719Z01	RUBBER,GSS
	<a href="#">7</a>	-----	BKT,CHAS REAR
	<a href="#">8</a>	03S60825Y04	SCR,B-T 3X8 ZN A
	<a href="#">9</a>	EN-20637Z06	NOSE,PIECE ASSY
	<a href="#">10</a>	13-20985Z01	NOSE,BOTTOM
	<a href="#">11</a>	03-02876Z28	SCR,WEV 1.7X7 ZB A
	<a href="#">12</a>	EN-13741Z01	NOSE,BASE ASSY
	<a href="#">13</a>	03S60822Y13	SCR,S-T 2.6X6 ZN A
	<a href="#">15</a>	-----	CHAS,BASE ASSY
	<a href="#">16</a>	-----	COVER,BOTTOM
	<a href="#">17</a>	-----	HEAT,SINK
	<a href="#">20</a>	33C04102K07	FACE,PLATE
	<a href="#">22</a>	84-09445Z02	FPC,11PIN MECH GOLD
	<a href="#">23</a>	DP-12685Z01	DP33U8BV
	<a href="#">27</a>	36-18731Z03	KNOB,ROTALY ASSY
	<a href="#">28</a>	14-14558Z01	INS,COVER MECH
	<a href="#">29</a>	75-06068Z64	CUS,RUB 14X4XT1.2
	<a href="#">31</a>	41-05515Z01	SPRING,OPEN
	<a href="#">32</a>	03S60822Y22	SCR,S-T 2.6X14 ZN A
	<a href="#">35</a>	26-21573Z01	SHIELD,HD BTM
	<a href="#">36</a>	26-21574Z01	SHIELD,HD TOP
	<a href="#">100</a>	SU-23194Z01	SERVICE_NOSE_138HD
	<a href="#">ANT6001</a>	09-17241Z05	ASSY,ANID-0116-05A
	<a href="#">CB460</a>	09-18716Z01	BTB,DF20-P -EJ
	<a href="#">CH5000</a>	09-18738Z01	BTB,DF20-S -DB
	<a href="#">DIN7000</a>	09-18874Z01	DIN,TCS7718-012117DB
	<a href="#">JK2600</a>	09-11352Z01	RCA,YKC21-4816N -DB
	<a href="#">JK400</a>	09-18872Z01	JAC,1850383000322-DB
	<a href="#">JK5300</a>	09-14149Z01	JAC,CK3-3.5-14D -DB
	<a href="#">LCD401</a>	65-21705Z01	LCD,TF5935M0TTN-FZ
	<a href="#">M8000</a>	59-06122Z02	MOTOR,D02X-12TS2 03
	<a href="#">SK400</a>	09-19382Z01	SKT,CM-V105 -DB
	<a href="#">SW418</a>	40-10735Z02	ENC,EC12D1524405 -DB
	<a href="#">SW5000</a>	40T16096W03	SW ,TACT SKHHLW
	<a href="#">VT8000</a>	24-02502Z02	ASSY,W277A001 -DB

# Exploded View (CD Deck Mechanism)

(DP33U8BV)

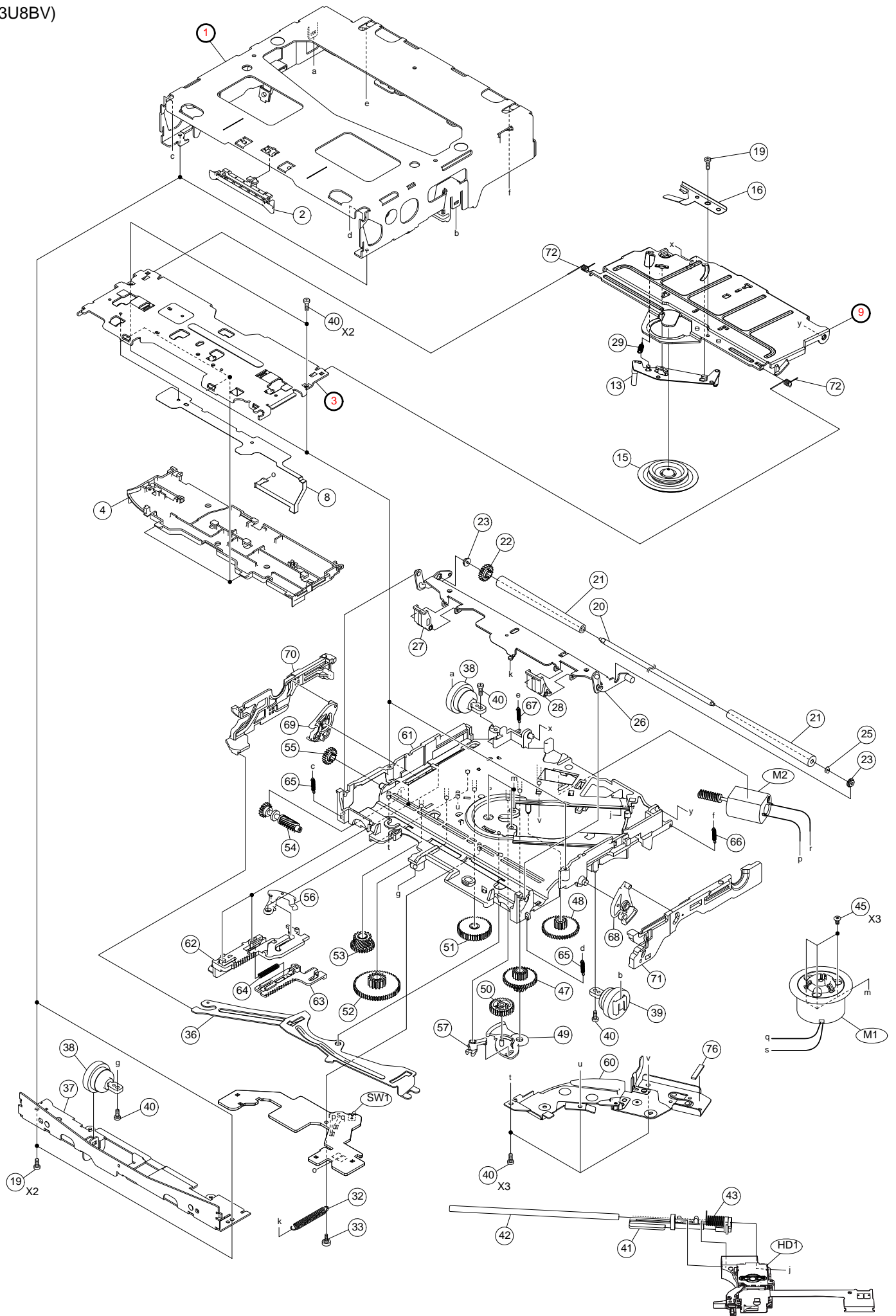

MODEL	Symbol No.	Parts No.	Description
	<a href="#">1</a>	-----	CHAS,BASE DP-U
	<a href="#">2</a>	15-08614Z01	GUIDE, TOP 2 DP-U
	<a href="#">3</a>	-----	CHAS, TOP 8LS
	<a href="#">4</a>	15-10062Z05	GUIDE, TOP 8LS
	<a href="#">8</a>	84-14334Z01	FPC, PHOTO VE
	<a href="#">9</a>	-----	ARM, CLAPM 8LS
	<a href="#">13</a>	45-10065Z04	LEVER, ACTUATOR 8LS
	<a href="#">15</a>	43-17679Z02	TABLE, CLAMPER 2
	<a href="#">16</a>	41-14419Z01	SPG, CLAMPER VE-2
	<a href="#">19</a>	03S60822Y43	SCR, S-T 2X3 ZN A
	<a href="#">20</a>	47-04894Z03	SHAFT, ROLLER DP-U
	<a href="#">21</a>	49-07008Z02	ROLLER, DP-U
	<a href="#">22</a>	44-08626Z01	GEAR, ROLLER
	<a href="#">23</a>	43-08617Z01	BUSH, ROLLER DP-U
	<a href="#">25</a>	04S40075G88	WAS, LOC 1.7X4.5X0.25
	<a href="#">26</a>	45-10061Z04	ARM, DISC GUIDE 8LS
	<a href="#">27</a>	45-08642Z01	ARM, FENCE L
	<a href="#">28</a>	45-08643Z01	ARM, FENCE R
	<a href="#">29</a>	41-05867Z14	SPRING, ACTUATOR-2
	<a href="#">32</a>	41-05867Z11	SPRING, ROLLER AOTA 2
	<a href="#">33</a>	03-10564Z02	SCR, SPG. ROLLER AOTA2
	<a href="#">36</a>	45-12698Z01	LEVER, LINK DRIVE 2
	<a href="#">37</a>	07-04867Z02	BKT, DAMPER
	<a href="#">38</a>	75-13914Z01	DAMPER, DP-U VE Z01
	<a href="#">39</a>	75-13914Z02	DAMPER, DP-U VE Z02
	<a href="#">40</a>	03S70693Y06	SCR, P-T 2X6 ZB A
	<a href="#">41</a>	44-08628Z01	RACK, SLED
	<a href="#">42</a>	47-04895Z01	SHAFT, PICK DP-U
	<a href="#">43</a>	41-05866Z02	SPRING, SLED
	<a href="#">45</a>	03S60820Y72	SCR, MCH 1.7X3 ZN A
	<a href="#">47</a>	44-08618Z04	GEAR, A
	<a href="#">48</a>	44-08619Z01	GEAR, B
	<a href="#">49</a>	45-08631Z01	LEVER, TIMING GEAR
	<a href="#">50</a>	44-08620Z01	GEAR, C
	<a href="#">51</a>	44-08621Z01	GEAR, D
	<a href="#">52</a>	44-08622Z04	GEAR, E
	<a href="#">53</a>	44-08623Z04	GEAR, F
	<a href="#">54</a>	44-08624Z03	GEAR, G
	<a href="#">55</a>	44-09654Z01	GEAR, H-2
	<a href="#">56</a>	45-08632Z01	LEVER, LOCK DP-U
	<a href="#">57</a>	45-08630Z01	LEVER, TIMING PICK
	<a href="#">60</a>	07-05523Z02	ASSY, RIV COVER MTR
	<a href="#">61</a>	27-19539Z01	CHAS, PICK 8LS 5
	<a href="#">62</a>	45-15742Z01	SLIDER, LOAD 2
	<a href="#">63</a>	45-15743Z01	SLIDER, TIMING LOAD 2

MODEL	Symbol No.	Parts No.	Description
	<a href="#">64</a>	41-05874Z02	SPRING,TIMING
	<a href="#">65</a>	41-05867Z02	SPRING,DRIVE F
	<a href="#">66</a>	41-05867Z13	SPRING,DRIVE RR-2
	<a href="#">67</a>	41-05867Z04	SPRING,DRIVE RL
	<a href="#">68</a>	45-08639Z06	ARM,LOCK R DP-U
	<a href="#">69</a>	45-15741Z01	ARM,LOCK L 2
	<a href="#">70</a>	45-10066Z04	SLIDER,LOCK L 8LS
	<a href="#">71</a>	45-10067Z04	SLIDER,LOCK R 8LS
	<a href="#">72</a>	41-05871Z02	SPRING,ARM CLAMP
	<a href="#">76</a>	14-06145Z92	INS,CVR 12X3XT1
	<a href="#">HD1</a>	EP-12502Z06	EP21A96NP
	<a href="#">M1</a>	66-19371Z75	ASSY,SPDL MTR 8BV
	<a href="#">M2</a>	66-13908Z44	ASSY,LD-SLED MTR AOTA 8BV
	<a href="#">SW1</a>	40T15494Y16	SW,DETCT SPVG1103-E6

P.W.Board	MIS	MODEL	Ref.	Parts No.	Parts Name
MAIN-P.W.Board			<a href="#">ANT6001</a>	09-17241Z05	ASSY,ANID-0116-05A
MAIN-P.W.Board			<a href="#">C1100</a>	08S45231Y11	CAP,CER 8R0D-CH1H-CP
MAIN-P.W.Board			<a href="#">C1101</a>	08S45232Y17	CAP,CER 104K-B0J -CP
MAIN-P.W.Board			<a href="#">C1102</a>	08S45232Y08	CAP,CER 332K-B1H -CP
MAIN-P.W.Board			<a href="#">C1103</a>	08S45676W69	CAP,CER.472K-B1H -CP
MAIN-P.W.Board			<a href="#">C1104</a>	08S45232Y12	CAP,CER 153K-B1C -CP
MAIN-P.W.Board			<a href="#">C1105</a>	08S45232Y17	CAP,CER 104K-B0J -CP
MAIN-P.W.Board			<a href="#">C1107</a>	08S45232Y17	CAP,CER 104K-B0J -CP
MAIN-P.W.Board			<a href="#">C1108</a>	08S45232Y17	CAP,CER 104K-B0J -CP
MAIN-P.W.Board			<a href="#">C1109</a>	08S45232Y17	CAP,CER 104K-B0J -CP
MAIN-P.W.Board			<a href="#">C1110</a>	08S45232Y14	CAP,CER 333K-B1C -CP
MAIN-P.W.Board			<a href="#">C1112</a>	08S45232Y14	CAP,CER 333K-B1C -CP
MAIN-P.W.Board			<a href="#">C1113</a>	08S45232Y08	CAP,CER 332K-B1H -CP
MAIN-P.W.Board			<a href="#">C1114</a>	08S45676W73	CAP,CER.103K-B1H -CP
MAIN-P.W.Board			<a href="#">C1115</a>	08S45232Y14	CAP,CER 333K-B1C -CP
MAIN-P.W.Board			<a href="#">C1116</a>	08S45232Y11	CAP,CER 103K-B1C -CP
MAIN-P.W.Board			<a href="#">C1117</a>	08S45232Y17	CAP,CER 104K-B0J -CP
MAIN-P.W.Board			<a href="#">C1118</a>	08S45231Y21	CAP,CER 47RJ-CH1H-CP
MAIN-P.W.Board			<a href="#">C1119</a>	08S45232Y12	CAP,CER 153K-B1C -CP
MAIN-P.W.Board			<a href="#">C1120</a>	08S45232Y07	CAP,CER 222K-B1H -CP
MAIN-P.W.Board			<a href="#">C1121</a>	08S45232Y17	CAP,CER 104K-B0J -CP
MAIN-P.W.Board			<a href="#">C1122</a>	08S45232Y17	CAP,CER 104K-B0J -CP
MAIN-P.W.Board			<a href="#">C1123</a>	08S45232Y17	CAP,CER 104K-B0J -CP
MAIN-P.W.Board			<a href="#">C1125</a>	08S45232Y14	CAP,CER 333K-B1C -CP
MAIN-P.W.Board			<a href="#">C1126</a>	08S45232Y05	CAP,CER 102K-B1H -CP
MAIN-P.W.Board			<a href="#">C1127</a>	08S35374W12	CAP,CER 106K-B0J -CP
MAIN-P.W.Board			<a href="#">C1128</a>	08S45232Y14	CAP,CER 333K-B1C -CP
MAIN-P.W.Board			<a href="#">C1129</a>	08S45232Y08	CAP,CER 332K-B1H -CP
MAIN-P.W.Board			<a href="#">C1130</a>	08S35374W12	CAP,CER 106K-B0J -CP
MAIN-P.W.Board			<a href="#">C1131</a>	08S45231Y13	CAP,CER 10RD-CH1H-CP
MAIN-P.W.Board			<a href="#">C1132</a>	08S45232Y17	CAP,CER 104K-B0J -CP
MAIN-P.W.Board			<a href="#">C1133</a>	08S45232Y17	CAP,CER 104K-B0J -CP
MAIN-P.W.Board			<a href="#">C1134</a>	08S35374W12	CAP,CER 106K-B0J -CP
MAIN-P.W.Board			<a href="#">C1136</a>	08S35349Y15	CAP,CER 474K-B1A -CP
MAIN-P.W.Board			<a href="#">C1137</a>	08S45232Y05	CAP,CER 102K-B1H -CP
MAIN-P.W.Board			<a href="#">C1138</a>	08S35349Y15	CAP,CER 474K-B1A -CP
MAIN-P.W.Board			<a href="#">C1139</a>	08S45232Y08	CAP,CER 332K-B1H -CP
MAIN-P.W.Board			<a href="#">C1140</a>	08S45232Y13	CAP,CER 223K-B1C -CP
MAIN-P.W.Board			<a href="#">C1142</a>	08S65669Y03	CAP,CER 224KX7R1H-CP
MAIN-P.W.Board			<a href="#">C1144</a>	08S45231Y15	CAP,CER 15RJ-CH1H-CP
MAIN-P.W.Board			<a href="#">C1145</a>	08S45231Y15	CAP,CER 15RJ-CH1H-CP
MAIN-P.W.Board			<a href="#">C1146</a>	08S45231Y15	CAP,CER 15RJ-CH1H-CP
MAIN-P.W.Board			<a href="#">C1201</a>	08S45232Y17	CAP,CER 104K-B0J -CP
MAIN-P.W.Board			<a href="#">C1202</a>	08S45232Y05	CAP,CER 102K-B1H -CP
MAIN-P.W.Board			<a href="#">C1203</a>	08S65668Y05	CAP,CER 224KX5R1A-CP

P.W.Board	MIS	MODEL	Ref.	Parts No.	Parts Name
MAIN-P.W.Board			<a href="#">C1204</a>	08S45232Y17	CAP,CER 104K-B0J -CP
MAIN-P.W.Board			<a href="#">C1206</a>	08S35349Y17	CAP,CER 225K-B0J -CP
MAIN-P.W.Board			<a href="#">C1207</a>	08S45231Y17	CAP,CER 22RJ-CH1H-CP
MAIN-P.W.Board			<a href="#">C1208</a>	08S45231Y16	CAP,CER 18RJ-CH1H-CP
MAIN-P.W.Board			<a href="#">C1209</a>	08S45232Y17	CAP,CER 104K-B0J -CP
MAIN-P.W.Board			<a href="#">C1210</a>	08S45232Y17	CAP,CER 104K-B0J -CP
MAIN-P.W.Board			<a href="#">C1211</a>	08S45231Y15	CAP,CER 15RJ-CH1H-CP
MAIN-P.W.Board			<a href="#">C1212</a>	08S45231Y15	CAP,CER 15RJ-CH1H-CP
MAIN-P.W.Board			<a href="#">C1215</a>	08S45231Y25	CAP,CER 101J-CH1H-CP
MAIN-P.W.Board			<a href="#">C1216</a>	08S45676W80	CAP,CER 223K-B1E -CP
MAIN-P.W.Board			<a href="#">C1217</a>	08S65667Y01	CAP,CER 224KX5R1C-CP
MAIN-P.W.Board			<a href="#">C1218</a>	08S45232Y17	CAP,CER 104K-B0J -CP
MAIN-P.W.Board			<a href="#">C1219</a>	08S45231Y25	CAP,CER 101J-CH1H-CP
MAIN-P.W.Board			<a href="#">C1220</a>	08S45231Y25	CAP,CER 101J-CH1H-CP
MAIN-P.W.Board			<a href="#">C1221</a>	08S45231Y25	CAP,CER 101J-CH1H-CP
MAIN-P.W.Board			<a href="#">C1222</a>	08S65667Y01	CAP,CER 224KX5R1C-CP
MAIN-P.W.Board			<a href="#">C1223</a>	08S45676W93	CAP,CER 224K-B1A -CP
MAIN-P.W.Board			<a href="#">C1300</a>	08S35349Y17	CAP,CER 225K-B0J -CP
MAIN-P.W.Board			<a href="#">C1301</a>	08S45232Y06	CAP,CER 152K-B1H -CP
MAIN-P.W.Board			<a href="#">C1302</a>	08S45231Y38	CAP,CER 102J-CH1E-CP
MAIN-P.W.Board			<a href="#">C1303</a>	08S65669Y03	CAP,CER 224KX7R1H-CP
MAIN-P.W.Board			<a href="#">C1304</a>	08S45231Y28	CAP,CER 181J-CH1H-CP
MAIN-P.W.Board			<a href="#">C1305</a>	08S45676W70	CAP,CER 562K-B1H -CP
MAIN-P.W.Board			<a href="#">C1306</a>	08S45676W75	CAP,CER.153K-B1H -CP
MAIN-P.W.Board			<a href="#">C1307</a>	08S45676W66	CAP,CER.272K-B1H -CP
MAIN-P.W.Board			<a href="#">C1308</a>	08S65669Y03	CAP,CER 224KX7R1H-CP
MAIN-P.W.Board			<a href="#">C1309</a>	08S65669Y03	CAP,CER 224KX7R1H-CP
MAIN-P.W.Board			<a href="#">C1310</a>	08S45676W93	CAP,CER 224K-B1A -CP
MAIN-P.W.Board			<a href="#">C1311</a>	08S45676W85	CAP,CER 104K-B1C -CP
MAIN-P.W.Board			<a href="#">C1800</a>	08S45232Y17	CAP,CER 104K-B0J -CP
MAIN-P.W.Board			<a href="#">C1801</a>	08S45232Y17	CAP,CER 104K-B0J -CP
MAIN-P.W.Board			<a href="#">C1802</a>	08S45232Y08	CAP,CER 332K-B1H -CP
MAIN-P.W.Board			<a href="#">C1803</a>	08S45232Y08	CAP,CER 332K-B1H -CP
MAIN-P.W.Board			<a href="#">C2100</a>	08S65676Y07	CAP,CER 225K-X7R1ECP
MAIN-P.W.Board			<a href="#">C2101</a>	08S65676Y07	CAP,CER 225K-X7R1ECP
MAIN-P.W.Board			<a href="#">C2111</a>	08S65669Y03	CAP,CER 224KX7R1H-CP
MAIN-P.W.Board			<a href="#">C2112</a>	08S45677W54	CAP,CER 561J-CH1H-CP
MAIN-P.W.Board			<a href="#">C2113</a>	08S45677W46	CAP,CER 271J-CH1H-CP
MAIN-P.W.Board			<a href="#">C2114</a>	08S45677W46	CAP,CER 271J-CH1H-CP
MAIN-P.W.Board			<a href="#">C2115</a>	08S45677W54	CAP,CER 561J-CH1H-CP
MAIN-P.W.Board			<a href="#">C2116</a>	08S65669Y03	CAP,CER 224KX7R1H-CP
MAIN-P.W.Board			<a href="#">C2118</a>	08S65669Y03	CAP,CER 224KX7R1H-CP
MAIN-P.W.Board			<a href="#">C2400</a>	08S45677W12	CAP,CER.10RD-CH1H-CP
MAIN-P.W.Board			<a href="#">C2401</a>	08S45677W12	CAP,CER.10RD-CH1H-CP
MAIN-P.W.Board			<a href="#">C2402</a>	08S45677W12	CAP,CER.10RD-CH1H-CP

P.W.Board	MIS	MODEL	Ref.	Parts No.	Parts Name
MAIN-P.W.Board			<a href="#">C2403</a>	08S45677W12	CAP,CER.10RD-CH1H-CP
MAIN-P.W.Board			<a href="#">C2404</a>	08S45677W12	CAP,CER.10RD-CH1H-CP
MAIN-P.W.Board			<a href="#">C2405</a>	08S45677W12	CAP,CER.10RD-CH1H-CP
MAIN-P.W.Board			<a href="#">C2406</a>	08T65463Y01	CAP,CER 335K-B1A -CP
MAIN-P.W.Board			<a href="#">C2407</a>	08T65463Y01	CAP,CER 335K-B1A -CP
MAIN-P.W.Board			<a href="#">C2408</a>	08S65669Y03	CAP,CER 224KX7R1H-CP
MAIN-P.W.Board			<a href="#">C2409</a>	08T65463Y01	CAP,CER 335K-B1A -CP
MAIN-P.W.Board			<a href="#">C2410</a>	08S45677W48	CAP,CER.331J-CH1H-CP
MAIN-P.W.Board			<a href="#">C2411</a>	08S45677W48	CAP,CER.331J-CH1H-CP
MAIN-P.W.Board			<a href="#">C2412</a>	08S45677W48	CAP,CER.331J-CH1H-CP
MAIN-P.W.Board			<a href="#">C2413</a>	08S45677W48	CAP,CER.331J-CH1H-CP
MAIN-P.W.Board			<a href="#">C2414</a>	08S45677W48	CAP,CER.331J-CH1H-CP
MAIN-P.W.Board			<a href="#">C2415</a>	08S45677W48	CAP,CER.331J-CH1H-CP
MAIN-P.W.Board			<a href="#">C2416</a>	08S45677W48	CAP,CER.331J-CH1H-CP
MAIN-P.W.Board			<a href="#">C2417</a>	08S45677W48	CAP,CER.331J-CH1H-CP
MAIN-P.W.Board			<a href="#">C2418</a>	08S45677W48	CAP,CER.331J-CH1H-CP
MAIN-P.W.Board			<a href="#">C2419</a>	08S45677W48	CAP,CER.331J-CH1H-CP
MAIN-P.W.Board			<a href="#">C2420</a>	08S45677W48	CAP,CER.331J-CH1H-CP
MAIN-P.W.Board			<a href="#">C2421</a>	08S45677W48	CAP,CER.331J-CH1H-CP
MAIN-P.W.Board			<a href="#">C2422</a>	08S45677W48	CAP,CER.331J-CH1H-CP
MAIN-P.W.Board			<a href="#">C2423</a>	08S45677W48	CAP,CER.331J-CH1H-CP
MAIN-P.W.Board			<a href="#">C2424</a>	08S45677W48	CAP,CER.331J-CH1H-CP
MAIN-P.W.Board			<a href="#">C2425</a>	08S45677W48	CAP,CER.331J-CH1H-CP
MAIN-P.W.Board			<a href="#">C2426</a>	08S45677W48	CAP,CER.331J-CH1H-CP
MAIN-P.W.Board			<a href="#">C2427</a>	08T65463Y01	CAP,CER 335K-B1A -CP
MAIN-P.W.Board			<a href="#">C2428</a>	08S65669Y03	CAP,CER 224KX7R1H-CP
MAIN-P.W.Board			<a href="#">C2429</a>	08S65669Y03	CAP,CER 224KX7R1H-CP
MAIN-P.W.Board			<a href="#">C2430</a>	08S65669Y03	CAP,CER 224KX7R1H-CP
MAIN-P.W.Board			<a href="#">C2431</a>	08S45677W48	CAP,CER.331J-CH1H-CP
MAIN-P.W.Board			<a href="#">C2500</a>	08S65676Y05	CAP,CER 105KX7R1E-CP
MAIN-P.W.Board			<a href="#">C2501</a>	08S65671Y01	CAP,CER 226KX5R1A-CP
MAIN-P.W.Board			<a href="#">C2502</a>	08S65676Y05	CAP,CER 105KX7R1E-CP
MAIN-P.W.Board			<a href="#">C2503</a>	08S65671Y01	CAP,CER 226KX5R1A-CP
MAIN-P.W.Board			<a href="#">C2505</a>	08S65676Y08	CAP,CER 106K-X7R1ACP
MAIN-P.W.Board			<a href="#">C2600</a>	08S45676W73	CAP,CER.103K-B1H -CP
MAIN-P.W.Board			<a href="#">C5000</a>	08S45676W85	CAP,CER 104K-B1C -CP
MAIN-P.W.Board			<a href="#">C5001</a>	08S45676W80	CAP,CER 223K-B1E -CP
MAIN-P.W.Board			<a href="#">C5002</a>	08S45676W85	CAP,CER 104K-B1C -CP
MAIN-P.W.Board			<a href="#">C5003</a>	08S45676W85	CAP,CER 104K-B1C -CP
MAIN-P.W.Board			<a href="#">C5004</a>	08S45676W85	CAP,CER 104K-B1C -CP
MAIN-P.W.Board			<a href="#">C5005</a>	08S45676W85	CAP,CER 104K-B1C -CP
MAIN-P.W.Board			<a href="#">C5006</a>	08S45676W80	CAP,CER 223K-B1E -CP
MAIN-P.W.Board			<a href="#">C5007</a>	08S45676W80	CAP,CER 223K-B1E -CP
MAIN-P.W.Board			<a href="#">C5008</a>	08S45231Y16	CAP,CER 18RJ-CH1H-CP
MAIN-P.W.Board			<a href="#">C5009</a>	08S45231Y17	CAP,CER 22RJ-CH1H-CP



P.W.Board	MIS	MODEL	Ref.	Parts No.	Parts Name
MAIN-P.W.Board			<a href="#">C5010</a>	08S45231Y15	CAP,CER 15RJ-CH1H-CP
MAIN-P.W.Board			<a href="#">C5011</a>	08S45231Y15	CAP,CER 15RJ-CH1H-CP
MAIN-P.W.Board			<a href="#">C5013</a>	08S65670Y04	CAP,CER 475KX5R1E-CP
MAIN-P.W.Board			<a href="#">C5014</a>	08S65669Y03	CAP,CER 224KX7R1H-CP
MAIN-P.W.Board			<a href="#">C5015</a>	08S45676W85	CAP,CER 104K-B1C -CP
MAIN-P.W.Board			<a href="#">C5016</a>	08S65128F90	CAP,CER 473K-B1H -CP
MAIN-P.W.Board			<a href="#">C5017</a>	08S45676W73	CAP,CER.103K-B1H -CP
MAIN-P.W.Board			<a href="#">C5300</a>	08S35374W01	CAP,CER 104K-B1E-CP
MAIN-P.W.Board			<a href="#">C5301</a>	08S65128F78	CAP,CER.223K-B1H -CP
MAIN-P.W.Board			<a href="#">C5302</a>	08S45676W65	CAP,CER.222K-B1H -CP
MAIN-P.W.Board			<a href="#">C5303</a>	08S45677W36	CAP,CER.101J-CH1H-CP
MAIN-P.W.Board			<a href="#">C5400</a>	08S65669Y03	CAP,CER 224KX7R1H-CP
MAIN-P.W.Board			<a href="#">C5401</a>	08S65669Y03	CAP,CER 224KX7R1H-CP
MAIN-P.W.Board			<a href="#">C5500</a>	08S65669Y03	CAP,CER 224KX7R1H-CP
MAIN-P.W.Board			<a href="#">C5507</a>	08S45676W60	CAP,CER.102J-SL1H-CP
MAIN-P.W.Board			<a href="#">C5511</a>	08S65669Y03	CAP,CER 224KX7R1H-CP
MAIN-P.W.Board			<a href="#">C5515</a>	08S65669Y03	CAP,CER 224KX7R1H-CP
MAIN-P.W.Board			<a href="#">C6000</a>	08S35349Y16	CAP,CER 105K-B1A -CP
MAIN-P.W.Board			<a href="#">C6001</a>	08S35374W12	CAP,CER 106K-B0J -CP
MAIN-P.W.Board			<a href="#">C6002</a>	08S35374W12	CAP,CER 106K-B0J -CP
MAIN-P.W.Board			<a href="#">C6004</a>	08S35374W12	CAP,CER 106K-B0J -CP
MAIN-P.W.Board			<a href="#">C6005</a>	08S35374W12	CAP,CER 106K-B0J -CP
MAIN-P.W.Board			<a href="#">C6006</a>	08S45231Y38	CAP,CER 102J-CH1E-CP
MAIN-P.W.Board			<a href="#">C6007</a>	08S45231Y38	CAP,CER 102J-CH1E-CP
MAIN-P.W.Board			<a href="#">C6008</a>	08S45231Y38	CAP,CER 102J-CH1E-CP
MAIN-P.W.Board			<a href="#">C6009</a>	08S35374W12	CAP,CER 106K-B0J -CP
MAIN-P.W.Board			<a href="#">C6010</a>	08S35374W12	CAP,CER 106K-B0J -CP
MAIN-P.W.Board			<a href="#">C6011</a>	08S35374W12	CAP,CER 106K-B0J -CP
MAIN-P.W.Board			<a href="#">C6012</a>	08S35374W12	CAP,CER 106K-B0J -CP
MAIN-P.W.Board			<a href="#">C6013</a>	08S45231Y38	CAP,CER 102J-CH1E-CP
MAIN-P.W.Board			<a href="#">C6014</a>	08S45676W65	CAP,CER.222K-B1H -CP
MAIN-P.W.Board			<a href="#">C6015</a>	08S35374W12	CAP,CER 106K-B0J -CP
MAIN-P.W.Board			<a href="#">C6016</a>	08S35374W12	CAP,CER 106K-B0J -CP
MAIN-P.W.Board			<a href="#">C6017</a>	08S35374W12	CAP,CER 106K-B0J -CP
MAIN-P.W.Board			<a href="#">C6019</a>	08S45232Y21	CAP,CER 104K-B1ACP
MAIN-P.W.Board			<a href="#">C6020</a>	08S35374W12	CAP,CER 106K-B0J -CP
MAIN-P.W.Board			<a href="#">C6021</a>	08S45231Y06	CAP,CER 3R0C-CJ1H-CP
MAIN-P.W.Board			<a href="#">C6022</a>	08S45677W60	CAP,CER 102J-CH1H-CP
MAIN-P.W.Board			<a href="#">C6023</a>	08S45232Y21	CAP,CER 104K-B1ACP
MAIN-P.W.Board			<a href="#">C6024</a>	08S65670Y01	CAP,CER 106KX5R1C-CP
MAIN-P.W.Board			<a href="#">C6025</a>	08S45232Y21	CAP,CER 104K-B1ACP
MAIN-P.W.Board			<a href="#">C6026</a>	08S45232Y05	CAP,CER 102K-B1H -CP
MAIN-P.W.Board			<a href="#">C6027</a>	08S35349Y17	CAP,CER 225K-B0J -CP
MAIN-P.W.Board			<a href="#">C6028</a>	08S35374W11	CAP,CER 475K-B0J -CP
MAIN-P.W.Board			<a href="#">C6030</a>	08S45232Y21	CAP,CER 104K-B1ACP

P.W.Board	MIS	MODEL	Ref.	Parts No.	Parts Name
MAIN-P.W.Board			<a href="#">C6031</a>	08S45232Y21	CAP,CER 104K-B1ACP
MAIN-P.W.Board			<a href="#">C6032</a>	08S45232Y08	CAP,CER 332K-B1H -CP
MAIN-P.W.Board			<a href="#">C6033</a>	08S45232Y05	CAP,CER 102K-B1H -CP
MAIN-P.W.Board			<a href="#">C6034</a>	08S45232Y05	CAP,CER 102K-B1H -CP
MAIN-P.W.Board			<a href="#">C6036</a>	08S45677W34	CAP,CER.82RJ-CH1H-CP
MAIN-P.W.Board			<a href="#">C6037</a>	08S45231Y17	CAP,CER 22RJ-CH1H-CP
MAIN-P.W.Board			<a href="#">C6038</a>	08S45231Y25	CAP,CER 101J-CH1H-CP
MAIN-P.W.Board			<a href="#">C6039</a>	08S45231Y13	CAP,CER 10RD-CH1H-CP
MAIN-P.W.Board			<a href="#">C6040</a>	08S45232Y03	CAP,CER 471K-B1H -CP
MAIN-P.W.Board			<a href="#">C6041</a>	08S82122F61	CAP,CER.102J-CH1H-CP
MAIN-P.W.Board			<a href="#">C6042</a>	08S45231Y38	CAP,CER 102J-CH1E-CP
MAIN-P.W.Board			<a href="#">C6043</a>	08S45231Y16	CAP,CER 18RJ-CH1H-CP
MAIN-P.W.Board			<a href="#">C6044</a>	08S45232Y07	CAP,CER 222K-B1H -CP
MAIN-P.W.Board			<a href="#">C6045</a>	08S45676W73	CAP,CER.103K-B1H -CP
MAIN-P.W.Board			<a href="#">C6047</a>	08S45676W73	CAP,CER.103K-B1H -CP
MAIN-P.W.Board			<a href="#">C6048</a>	08S65668Y05	CAP,CER 224KX5R1A-CP
MAIN-P.W.Board			<a href="#">C6049</a>	08S45231Y06	CAP,CER 3R0C-CJ1H-CP
MAIN-P.W.Board			<a href="#">C6050</a>	08S45231Y06	CAP,CER 3R0C-CJ1H-CP
MAIN-P.W.Board			<a href="#">C6055</a>	08S45231Y38	CAP,CER 102J-CH1E-CP
MAIN-P.W.Board			<a href="#">C6056</a>	08S65676Y08	CAP,CER 106K-X7R1ACP
MAIN-P.W.Board			<a href="#">C6057</a>	08S45232Y17	CAP,CER 104K-B0J -CP
MAIN-P.W.Board			<a href="#">C6060</a>	08S45232Y17	CAP,CER 104K-B0J -CP
MAIN-P.W.Board			<a href="#">C6061</a>	08S45231Y38	CAP,CER 102J-CH1E-CP
MAIN-P.W.Board			<a href="#">C6062</a>	08S65670Y01	CAP,CER 106KX5R1C-CP
MAIN-P.W.Board			<a href="#">C7001</a>	08S35350Y03	CAP,CER 224K-B1C -CP
MAIN-P.W.Board			<a href="#">C7003</a>	08S45676W65	CAP,CER.222K-B1H -CP
MAIN-P.W.Board			<a href="#">C7007</a>	08S45539Y04	CAP,CER 103KX7R2J-CP
MAIN-P.W.Board			<a href="#">C7100</a>	08S35349Y16	CAP,CER 105K-B1A -CP
MAIN-P.W.Board			<a href="#">C7101</a>	08S35349Y16	CAP,CER 105K-B1A -CP
MAIN-P.W.Board			<a href="#">C7103</a>	08S45231Y14	CAP,CER 12RJ-CH1H-CP
MAIN-P.W.Board			<a href="#">C7104</a>	08S45231Y14	CAP,CER 12RJ-CH1H-CP
MAIN-P.W.Board			<a href="#">C7300</a>	08S65667Y01	CAP,CER 224KX5R1C-CP
MAIN-P.W.Board			<a href="#">C8000</a>	08S65669Y03	CAP,CER 224KX7R1H-CP
MAIN-P.W.Board			<a href="#">C8001</a>	08S65669Y03	CAP,CER 224KX7R1H-CP
MAIN-P.W.Board			<a href="#">C8002</a>	08S45676W85	CAP,CER 104K-B1C -CP
MAIN-P.W.Board			<a href="#">C8003</a>	08S65669Y03	CAP,CER 224KX7R1H-CP
MAIN-P.W.Board			<a href="#">C8004</a>	08S65669Y03	CAP,CER 224KX7R1H-CP
MAIN-P.W.Board			<a href="#">C8005</a>	08S65669Y03	CAP,CER 224KX7R1H-CP
MAIN-P.W.Board			<a href="#">C8006</a>	08S65669Y03	CAP,CER 224KX7R1H-CP
MAIN-P.W.Board			<a href="#">C8007</a>	08S65669Y03	CAP,CER 224KX7R1H-CP
MAIN-P.W.Board			<a href="#">C8008</a>	08S65669Y03	CAP,CER 224KX7R1H-CP
MAIN-P.W.Board			<a href="#">C8009</a>	08S65669Y03	CAP,CER 224KX7R1H-CP
MAIN-P.W.Board			<a href="#">C8011</a>	08S65669Y03	CAP,CER 224KX7R1H-CP
MAIN-P.W.Board			<a href="#">C8012</a>	08S65669Y03	CAP,CER 224KX7R1H-CP
MAIN-P.W.Board			<a href="#">C8013</a>	08S45232Y05	CAP,CER 102K-B1H -CP

P.W.Board	MIS	MODEL	Ref.	Parts No.	Parts Name
MAIN-P.W.Board			<a href="#">C8014</a>	08S45677W36	CAP,CER.101J-CH1H-CP
MAIN-P.W.Board			<a href="#">C8017</a>	06S70072F77	RES,CP .103-J-1/4-CP
MAIN-P.W.Board			<a href="#">C8018</a>	08S65669Y03	CAP,CER 224KX7R1H-CP
MAIN-P.W.Board			<a href="#">C8019</a>	08S45676W85	CAP,CER 104K-B1C -CP
MAIN-P.W.Board			<a href="#">C8020</a>	08S65669Y03	CAP,CER 224KX7R1H-CP
MAIN-P.W.Board			<a href="#">C8022</a>	08S45676W83	CAP,CER 473K-B1C -CP
MAIN-P.W.Board			<a href="#">C8023</a>	08S65669Y03	CAP,CER 224KX7R1H-CP
MAIN-P.W.Board			<a href="#">C8024</a>	08S65669Y03	CAP,CER 224KX7R1H-CP
MAIN-P.W.Board			<a href="#">C8025</a>	08S65669Y03	CAP,CER 224KX7R1H-CP
MAIN-P.W.Board			<a href="#">C8026</a>	08S65669Y03	CAP,CER 224KX7R1H-CP
MAIN-P.W.Board			<a href="#">C8027</a>	08S35349Y16	CAP,CER 105K-B1A -CP
MAIN-P.W.Board			<a href="#">C8029</a>	08S35350Y04	CAP,CER 105K-B1C -CP
MAIN-P.W.Board			<a href="#">C8033</a>	08S65669Y03	CAP,CER 224KX7R1H-CP
MAIN-P.W.Board			<a href="#">C8060</a>	08S65669Y03	CAP,CER 224KX7R1H-CP
MAIN-P.W.Board			<a href="#">C8061</a>	08S65669Y03	CAP,CER 224KX7R1H-CP
MAIN-P.W.Board			<a href="#">C8062</a>	08S65669Y03	CAP,CER 224KX7R1H-CP
MAIN-P.W.Board			<a href="#">C8063</a>	08S65669Y03	CAP,CER 224KX7R1H-CP
MAIN-P.W.Board			<a href="#">C8064</a>	08S45676W85	CAP,CER 104K-B1C -CP
MAIN-P.W.Board			<a href="#">C8065</a>	08S45232Y11	CAP,CER 103K-B1C -CP
MAIN-P.W.Board			<a href="#">C8066</a>	08S65669Y03	CAP,CER 224KX7R1H-CP
MAIN-P.W.Board			<a href="#">C8067</a>	08S45676W73	CAP,CER.103K-B1H -CP
MAIN-P.W.Board			<a href="#">C8068</a>	08S65669Y03	CAP,CER 224KX7R1H-CP
MAIN-P.W.Board			<a href="#">C8069</a>	08S65669Y03	CAP,CER 224KX7R1H-CP
MAIN-P.W.Board			<a href="#">C8070</a>	08S65669Y03	CAP,CER 224KX7R1H-CP
MAIN-P.W.Board			<a href="#">C8071</a>	08S65669Y03	CAP,CER 224KX7R1H-CP
MAIN-P.W.Board			<a href="#">C8072</a>	08S65669Y03	CAP,CER 224KX7R1H-CP
MAIN-P.W.Board			<a href="#">C8073</a>	08S65669Y03	CAP,CER 224KX7R1H-CP
MAIN-P.W.Board			<a href="#">C8074</a>	08S65667Y01	CAP,CER 224KX5R1C-CP
MAIN-P.W.Board			<a href="#">C8075</a>	08S65674Y05	CAP,CER 105KX5R1C-CP
MAIN-P.W.Board			<a href="#">C8076</a>	08S65669Y03	CAP,CER 224KX7R1H-CP
MAIN-P.W.Board			<a href="#">C8080</a>	08S45676W71	CAP,CER.682K-B1H -CP
MAIN-P.W.Board			<a href="#">C8081</a>	08S45676W85	CAP,CER 104K-B1C -CP
MAIN-P.W.Board			<a href="#">C8084</a>	08S65670Y07	CAP,CER 105KX5R1H-CP
MAIN-P.W.Board			<a href="#">CB1100</a>	09-09312Z02	FFC,IMSA9663S-15Y-EQ
MAIN-P.W.Board			<a href="#">CB1300</a>	09T55174Y11	FFC,IMSA9616S-11Y-ED
MAIN-P.W.Board			<a href="#">CB8000</a>	09T25436Y02	WTB,53253-0270 -DB
MAIN-P.W.Board			<a href="#">CH5000</a>	09-18738Z01	BTB,DF20-S -DB
MAIN-P.W.Board			<a href="#">CH7100</a>	09-21046Z01	BTB,24R-JMCS-G-B -E5
MAIN-P.W.Board			<a href="#">D2600</a>	48-07016Z01	DIO,KDS181-RTK -CP
MAIN-P.W.Board			<a href="#">D2601</a>	48-07016Z01	DIO,KDS181-RTK -CP
MAIN-P.W.Board			<a href="#">D2602</a>	48-07016Z01	DIO,KDS181-RTK -CP
MAIN-P.W.Board			<a href="#">D5300</a>	48-05965Z01	DIO,1SS361-L -CP
MAIN-P.W.Board			<a href="#">D6001</a>	48-12230Z01	DIO,KDS226-RTK -CP
MAIN-P.W.Board			<a href="#">D8000</a>	48T75527Y01	DIO,1SR154-400 -E1
MAIN-P.W.Board			<a href="#">D8001</a>	48T75527Y01	DIO,1SR154-400 -E1

P.W.Board	MIS	MODEL	Ref.	Parts No.	Parts Name
MAIN-P.W.Board			<a href="#">D8002</a>	48T75527Y01	DIO,1SR154-400 -E1
MAIN-P.W.Board			<a href="#">D8003</a>	48T75527Y01	DIO,1SR154-400 -E1
MAIN-P.W.Board			<a href="#">D8004</a>	48T75527Y01	DIO,1SR154-400 -E1
MAIN-P.W.Board			<a href="#">D8005</a>	48-07015Z01	DIO,KDS160-RTK -CP
MAIN-P.W.Board			<a href="#">D8006</a>	48-07015Z01	DIO,KDS160-RTK -CP
MAIN-P.W.Board			<a href="#">D8007</a>	48-07015Z01	DIO,KDS160-RTK -CP
MAIN-P.W.Board			<a href="#">D8009</a>	48-07015Z01	DIO,KDS160-RTK -CP
MAIN-P.W.Board			<a href="#">D8010</a>	48T75527Y01	DIO,1SR154-400 -E1
MAIN-P.W.Board			<a href="#">D8011</a>	48T75527Y01	DIO,1SR154-400 -E1
MAIN-P.W.Board			<a href="#">D8012</a>	48T75527Y01	DIO,1SR154-400 -E1
MAIN-P.W.Board			<a href="#">DIN7000</a>	09-18874Z01	DIN,TCS7718-012117DB
MAIN-P.W.Board			<a href="#">E1100</a>	23S75244Y19	CAP,ELY 101-1C -E6
MAIN-P.W.Board			<a href="#">E1102</a>	23T65679Y11	CAP,CD 47R-0J -E2
MAIN-P.W.Board			<a href="#">E1300</a>	23S75244Y20	CAP,ELY 221-1C -E6
MAIN-P.W.Board			<a href="#">E1800</a>	23S75244Y16	CAP,ELY 10R-1C -E2
MAIN-P.W.Board			<a href="#">E1801</a>	23S75244Y16	CAP,ELY 10R-1C -E2
MAIN-P.W.Board			<a href="#">E1802</a>	23S75244Y16	CAP,ELY 10R-1C -E2
MAIN-P.W.Board			<a href="#">E1803</a>	23S75244Y16	CAP,ELY 10R-1C -E2
MAIN-P.W.Board			<a href="#">E2102</a>	23T75234Y06	CAP,MAR 22R-1C-E55E3
MAIN-P.W.Board			<a href="#">E2103</a>	23T75234Y06	CAP,MAR 22R-1C-E55E3
MAIN-P.W.Board			<a href="#">E2104</a>	23T75234Y07	CAP,MAR 47R-1C-F55E6
MAIN-P.W.Board			<a href="#">E2400</a>	23S65134W51	CAP,ELY 2R2-1V(3)-E2
MAIN-P.W.Board			<a href="#">E2401</a>	23S65134W51	CAP,ELY 2R2-1V(3)-E2
MAIN-P.W.Board			<a href="#">E2402</a>	23S65134W51	CAP,ELY 2R2-1V(3)-E2
MAIN-P.W.Board			<a href="#">E2403</a>	23S65134W51	CAP,ELY 2R2-1V(3)-E2
MAIN-P.W.Board			<a href="#">E2404</a>	23S65134W51	CAP,ELY 2R2-1V(3)-E2
MAIN-P.W.Board			<a href="#">E2405</a>	23S65134W51	CAP,ELY 2R2-1V(3)-E2
MAIN-P.W.Board			<a href="#">E2500</a>	23S65134W23	CAP,ELY 101-1A(6)-E6
MAIN-P.W.Board			<a href="#">E2501</a>	23-02519Z15	CAP,FC 22R-1C-C -E3
MAIN-P.W.Board			<a href="#">E2502</a>	23-02519Z15	CAP,FC 22R-1C-C -E3
MAIN-P.W.Board			<a href="#">E2600</a>	23S65134W52	CAP,ELY 3R3-1V(3)-E2
MAIN-P.W.Board			<a href="#">E2601</a>	23S65134W52	CAP,ELY 3R3-1V(3)-E2
MAIN-P.W.Board			<a href="#">E2602</a>	23S65134W52	CAP,ELY 3R3-1V(3)-E2
MAIN-P.W.Board			<a href="#">E2603</a>	23S65134W52	CAP,ELY 3R3-1V(3)-E2
MAIN-P.W.Board			<a href="#">E2604</a>	23S65134W52	CAP,ELY 3R3-1V(3)-E2
MAIN-P.W.Board			<a href="#">E2605</a>	23S65134W52	CAP,ELY 3R3-1V(3)-E2
MAIN-P.W.Board			<a href="#">E5001</a>	23T65114Y17	CAP,FK 10R-1C-B -E2
MAIN-P.W.Board			<a href="#">E5002</a>	23S65134W41	CAP,ELY 4R7-1E(3)-E2
MAIN-P.W.Board			<a href="#">E5003</a>	23S65134W15	CAP,ELY 331-0J(8)-E6
MAIN-P.W.Board			<a href="#">E5400</a>	23S75244Y16	CAP,ELY 10R-1C -E2
MAIN-P.W.Board			<a href="#">E5401</a>	23S75244Y16	CAP,ELY 10R-1C -E2
MAIN-P.W.Board			<a href="#">E5500</a>	23S75244Y25	CAP,ELY 22R-1E -E3
MAIN-P.W.Board			<a href="#">E5501</a>	23S75244Y27	CAP,ELY 47R-1E -E6
MAIN-P.W.Board			<a href="#">E7000</a>	23S75244Y16	CAP,ELY 10R-1C -E2
MAIN-P.W.Board			<a href="#">E7100</a>	23S65134W24	CAP,ELY 221-1A(8)-E6

P.W.Board	MIS	MODEL	Ref.	Parts No.	Parts Name
MAIN-P.W.Board			<a href="#">E7300</a>	23S65134W81	CAP,ELY 22R-1C(4)-E2
MAIN-P.W.Board			<a href="#">E8000</a>	23S75244Y20	CAP,ELY 221-1C -E6
MAIN-P.W.Board			<a href="#">E8001</a>	23S75244Y26	CAP,ELY 33R-1E -E3
MAIN-P.W.Board			<a href="#">E8002</a>	23S75244Y19	CAP,ELY 101-1C -E6
MAIN-P.W.Board			<a href="#">E8003</a>	23S75244Y18	CAP,ELY 47R-1C -E3
MAIN-P.W.Board			<a href="#">E8004</a>	23T65114Y07	CAP,FK 331-0J-D8-E6
MAIN-P.W.Board			<a href="#">E8006</a>	23S75244Y04	CAP,ELY 221-0J -E6
MAIN-P.W.Board			<a href="#">E8007</a>	23T75346W03	CAP,X-PRO 332-1C +
MAIN-P.W.Board			<a href="#">E8008</a>	23S75244Y17	CAP,ELY 22R-1C -E2
MAIN-P.W.Board			<a href="#">E8009</a>	23T65114Y32	CAP,FK 4R7-1V-B -E2
MAIN-P.W.Board			<a href="#">E8010</a>	23S65134W34	CAP,ELY 47R-1C(6)-E6
MAIN-P.W.Board			<a href="#">E8011</a>	23S65134W65	CAP,ELY 1R0-1H(3)-E2
MAIN-P.W.Board			<a href="#">E8012</a>	23S75244Y19	CAP,ELY 101-1C -E6
MAIN-P.W.Board			<a href="#">E8017</a>	23S75244Y19	CAP,ELY 101-1C -E6
MAIN-P.W.Board			<a href="#">E8018</a>	23S75244Y19	CAP,ELY 101-1C -E6
MAIN-P.W.Board			<a href="#">E8019</a>	23S75244Y19	CAP,ELY 101-1C -E6
MAIN-P.W.Board			<a href="#">E8020</a>	23S75244Y19	CAP,ELY 101-1C -E6
MAIN-P.W.Board			<a href="#">E8021</a>	23S75244Y20	CAP,ELY 221-1C -E6
MAIN-P.W.Board			<a href="#">E8022</a>	23S75244Y28	CAP,ELY 101-1E -E6
MAIN-P.W.Board			<a href="#">E8023</a>	23S65134W31	CAP,ELY 10R-1C(4)-E2
MAIN-P.W.Board			<a href="#">E8024</a>	23S65134W31	CAP,ELY 10R-1C(4)-E2
MAIN-P.W.Board			<a href="#">E8025</a>	23S65134W31	CAP,ELY 10R-1C(4)-E2
MAIN-P.W.Board			<a href="#">E8026</a>	23S65134W31	CAP,ELY 10R-1C(4)-E2
MAIN-P.W.Board			<a href="#">E8027</a>	23S75244Y27	CAP,ELY 47R-1E -E6
MAIN-P.W.Board			<a href="#">E8028</a>	23S75244Y19	CAP,ELY 101-1C -E6
MAIN-P.W.Board			<a href="#">E8029</a>	23S75244Y19	CAP,ELY 101-1C -E6
MAIN-P.W.Board			<a href="#">E8030</a>	23S65134W34	CAP,ELY 47R-1C(6)-E6
MAIN-P.W.Board			<a href="#">E8031</a>	23S75244Y18	CAP,ELY 47R-1C -E3
MAIN-P.W.Board			<a href="#">E8032</a>	23T65679Y11	CAP,CD 47R-0J -E2
MAIN-P.W.Board			<a href="#">E8033</a>	23S75244Y19	CAP,ELY 101-1C -E6
MAIN-P.W.Board			<a href="#">E8034</a>	23T65114Y07	CAP,FK 331-0J-D8-E6
MAIN-P.W.Board			<a href="#">E8035</a>	23S75244Y20	CAP,ELY 221-1C -E6
MAIN-P.W.Board			<a href="#">IC1100</a>	51T15185Y02	TC7SH08FU,JF-L -CP
MAIN-P.W.Board			<a href="#">IC1101</a>	51-16202Z01	TC94A92FG-301 -QT
MAIN-P.W.Board			<a href="#">IC1200</a>	83-22939Z09	12MY_FBI_HD_Bolero_Soft
MAIN-P.W.Board			<a href="#">IC1300</a>	51-14737Z01	BD8226EFV-E2 -SE6
MAIN-P.W.Board			<a href="#">IC1800</a>	51-06963Z01	NJU7741F15-TE1 -CP
MAIN-P.W.Board			<a href="#">IC1801</a>	51-06963Z01	NJU7741F15-TE1 -CP
MAIN-P.W.Board			<a href="#">IC2100</a>	51-19762Z01	BD37543FS-E2 -SE9
MAIN-P.W.Board			<a href="#">IC2101</a>	51-05314Z01	BA4560RFVM-TR -SE1
MAIN-P.W.Board			<a href="#">IC2400</a>	51T93340F02	NJM2060V-TE2 -SE2
MAIN-P.W.Board			<a href="#">IC2401</a>	51T15420Y01	BA4560F-E2 -SE2
MAIN-P.W.Board			<a href="#">IC2500</a>	51-20907Z01	TPS60402QDBVRQ1 -CP
MAIN-P.W.Board			<a href="#">IC5001</a>	51-22572Z01	S-24C512CI-T8T5 -SE2
MAIN-P.W.Board			<a href="#">IC5002</a>	83-22939Z08	12MY_FBI_SOFT

P.W.Board	MIS	MODEL	Ref.	Parts No.	Parts Name
MAIN-P.W.Board			<a href="#">IC5003</a>	51T75063Y06	BD5228G-TR -CP
MAIN-P.W.Board			<a href="#">IC5300</a>	51T93532F05	TC4S01F-TE85L -CP
MAIN-P.W.Board			<a href="#">IC5400</a>	51T15194Y02	TC74VHCT08AFT,K -SE5
MAIN-P.W.Board			<a href="#">IC5401</a>	51T15191Y02	TC74VHC08FT,K-EL-SE5
MAIN-P.W.Board			<a href="#">IC5504</a>	51T55336Y02	TC7SH04FU,JF-L -CP
MAIN-P.W.Board			<a href="#">IC6001</a>	51-22873Z01	TEA6636HW/V103 -QT
MAIN-P.W.Board			<a href="#">IC7000</a>	51-04637Z01	TC74ACT04FT-EL -SE5
MAIN-P.W.Board			<a href="#">IC7001</a>	51-20732Z03	ASSY,FC6000 PF810010
MAIN-P.W.Board			<a href="#">IC7300</a>	51-15224Z01	MFI341S2313 -SE2
MAIN-P.W.Board			<a href="#">IC8000</a>	51-18256Z01	LV5681P -ZS
MAIN-P.W.Board			<a href="#">IC8001</a>	51-05862Z01	NJM2845DL1-33-TE1NE5
MAIN-P.W.Board			<a href="#">IC8002</a>	51T65016Y46	S-80960CNMC-T2 -CP
MAIN-P.W.Board			<a href="#">IC8003</a>	51-18346Z01	TB2986HQ -ZS
MAIN-P.W.Board			<a href="#">IC8004</a>	51-05862Z01	NJM2845DL1-33-TE1NE5
MAIN-P.W.Board			<a href="#">IC8006</a>	51-11433Z01	RT9702AGB -CP
MAIN-P.W.Board			<a href="#">IC8007</a>	51T75222Y02	BA033CC0WFP-E2 -NE5
MAIN-P.W.Board			<a href="#">IC8008</a>	51-02830Z01	BA7810HFP -NEA
MAIN-P.W.Board			<a href="#">IC8009</a>	51-13565Z03	NJM2856DL3-33TE1-NE5
MAIN-P.W.Board			<a href="#">IC8010</a>	51-13565Z01	NJM2856DL3-18TE1-NE5
MAIN-P.W.Board			<a href="#">IC8011</a>	51-02248Z01	BD9781HFP-TR -NEA
MAIN-P.W.Board			<a href="#">JK2600</a>	09-11352Z01	RCA,YKC21-4816N -DB
MAIN-P.W.Board			<a href="#">JK5300</a>	09-14149Z01	JAC,CK3-3.5-14D -DB
MAIN-P.W.Board			<a href="#">L1100</a>	24T95456W07	FBI,BLM18BD102SH1-CP
MAIN-P.W.Board			<a href="#">L1101</a>	24T95456W07	FBI,BLM18BD102SH1-CP
MAIN-P.W.Board			<a href="#">L1102</a>	24T95456W07	FBI,BLM18BD102SH1-CP
MAIN-P.W.Board			<a href="#">L2500</a>	24T95202W25	IND,CDRH64B 102M -E6
MAIN-P.W.Board			<a href="#">L2501</a>	24T95202W25	IND,CDRH64B 102M -E6
MAIN-P.W.Board			<a href="#">L6000</a>	24T95456W11	FBI,BLM18AG601SH1-CP
MAIN-P.W.Board			<a href="#">L6001</a>	24T95458W07	FBI,BLM31PG601SH1-CP
MAIN-P.W.Board			<a href="#">L6002</a>	24T95456W11	FBI,BLM18AG601SH1-CP
MAIN-P.W.Board			<a href="#">L6003</a>	24T95456W11	FBI,BLM18AG601SH1-CP
MAIN-P.W.Board			<a href="#">L6004</a>	24T95456W11	FBI,BLM18AG601SH1-CP
MAIN-P.W.Board			<a href="#">L6005</a>	24T45482Y05	IND,LQH31HN R29J -CP
MAIN-P.W.Board			<a href="#">L6006</a>	24T25164Y12	IND,FSLM2520 R82J-CP
MAIN-P.W.Board			<a href="#">L6007</a>	24T25164Y19	IND,FSLM2520 3R3J-CP
MAIN-P.W.Board			<a href="#">L6008</a>	24T55488Y37	IND,LLQ1608 R27J -CP
MAIN-P.W.Board			<a href="#">L6009</a>	24T65645Y03	IND,LLM3225 561K -CP
MAIN-P.W.Board			<a href="#">L6010</a>	24T65645Y03	IND,LLM3225 561K -CP
MAIN-P.W.Board			<a href="#">L6011</a>	24T95459W07	FBI,BLM41PG102SH1-E1
MAIN-P.W.Board			<a href="#">L6012</a>	24T95456W11	FBI,BLM18AG601SH1-CP
MAIN-P.W.Board			<a href="#">L6014</a>	24T65645Y01	IND,LLM3225 4R7J -CP
MAIN-P.W.Board			<a href="#">L6201</a>	24T95459W07	FBI,BLM41PG102SH1-E1
MAIN-P.W.Board			<a href="#">L8002</a>	24-05496Z01	IND,SLF12575-H33RMEA
MAIN-P.W.Board			<a href="#">PS7000</a>	48-16589Z03	POLY,SW SMD150F -E2
MAIN-P.W.Board			<a href="#">Q1100</a>	48T55462Y01	TR,2SB1132-QR-100-E2

P.W.Board	MIS	MODEL	Ref.	Parts No.	Parts Name
MAIN-P.W.Board			<a href="#">Q1200</a>	48-08605Z01	TR,2SA2048-TL -CP
MAIN-P.W.Board			<a href="#">Q1201</a>	48T94606F09	TR,DTC143XUA-T106-CP
MAIN-P.W.Board			<a href="#">Q1300</a>	48-04940Z17	TR,KRA118S-RTK -CP
MAIN-P.W.Board			<a href="#">Q1301</a>	48-19949Z01	TR,DRC5143X -CP
MAIN-P.W.Board			<a href="#">Q1800</a>	48-17707Z02	TR,DSA7003S0L -E2
MAIN-P.W.Board			<a href="#">Q1801</a>	48-19949Z01	TR,DRC5143X -CP
MAIN-P.W.Board			<a href="#">Q2500</a>	48-04940Z17	TR,KRA118S-RTK -CP
MAIN-P.W.Board			<a href="#">Q2501</a>	48-04929Z18	TR,KRC119S-RTK -CP
MAIN-P.W.Board			<a href="#">Q2600</a>	48T75180Y04	TR,IMH23-T110 -CP
MAIN-P.W.Board			<a href="#">Q2601</a>	48T75180Y04	TR,IMH23-T110 -CP
MAIN-P.W.Board			<a href="#">Q2602</a>	48T75180Y04	TR,IMH23-T110 -CP
MAIN-P.W.Board			<a href="#">Q3400</a>	48T25737Y02	TR,UMD3N-TR -CP
MAIN-P.W.Board			<a href="#">Q5300</a>	48-09583Z04	TR,KTA1504S-GRRTK-CP
MAIN-P.W.Board			<a href="#">Q5301</a>	48-04929Z02	TR,KRC102S-RTK -CP
MAIN-P.W.Board			<a href="#">Q5503</a>	48-19949Z01	TR,DRC5143X -CP
MAIN-P.W.Board			<a href="#">Q5504</a>	48-09581Z04	TR,KTA1505S-GRRTK-CP
MAIN-P.W.Board			<a href="#">Q6001</a>	48-20742Z01	TR,BCX54 -E2
MAIN-P.W.Board			<a href="#">Q7000</a>	48-19949Z01	TR,DRC5143X -CP
MAIN-P.W.Board			<a href="#">Q7001</a>	48T25737Y02	TR,UMD3N-TR -CP
MAIN-P.W.Board			<a href="#">Q7300</a>	48-09583Z04	TR,KTA1504S-GRRTK-CP
MAIN-P.W.Board			<a href="#">Q7301</a>	48-19949Z01	TR,DRC5143X -CP
MAIN-P.W.Board			<a href="#">Q8000</a>	48-19949Z01	TR,DRC5143X -CP
MAIN-P.W.Board			<a href="#">Q8001</a>	48-19949Z01	TR,DRC5143X -CP
MAIN-P.W.Board			<a href="#">Q8002</a>	48-09581Z04	TR,KTA1505S-GRRTK-CP
MAIN-P.W.Board			<a href="#">Q8003</a>	48-19949Z01	TR,DRC5143X -CP
MAIN-P.W.Board			<a href="#">Q8004</a>	48T25737Y01	TR,UMD2N-TR -CP
MAIN-P.W.Board			<a href="#">Q8005</a>	48T25737Y01	TR,UMD2N-TR -CP
MAIN-P.W.Board			<a href="#">Q8006</a>	48T25737Y01	TR,UMD2N-TR -CP
MAIN-P.W.Board			<a href="#">Q8008</a>	48-04929Z03	TR,KRC103S-RTK -CP
MAIN-P.W.Board			<a href="#">Q8009</a>	48-04929Z03	TR,KRC103S-RTK -CP
MAIN-P.W.Board			<a href="#">Q8010</a>	48-04929Z02	TR,KRC102S-RTK -CP
MAIN-P.W.Board			<a href="#">Q8011</a>	48T25737Y02	TR,UMD3N-TR -CP
MAIN-P.W.Board			<a href="#">Q8012</a>	48-04929Z03	TR,KRC103S-RTK -CP
MAIN-P.W.Board			<a href="#">Q8014</a>	48-19949Z01	TR,DRC5143X -CP
MAIN-P.W.Board			<a href="#">Q8025</a>	48-20989Z01	TR,DSC700300L -E2
MAIN-P.W.Board			<a href="#">R1100</a>	06S15615Y72	RES,RK 912J 1/16 -CP
MAIN-P.W.Board			<a href="#">R1101</a>	06S15615Y72	RES,RK 912J 1/16 -CP
MAIN-P.W.Board			<a href="#">R1102</a>	06S15615Y72	RES,RK 912J 1/16 -CP
MAIN-P.W.Board			<a href="#">R1104</a>	06S15615Y89	RES,RK 473J 1/16 -CP
MAIN-P.W.Board			<a href="#">R1105</a>	06S15615Y49	RES,RK 102J 1/16 -CP
MAIN-P.W.Board			<a href="#">R1106</a>	06S15616Y22	RES,RK 105J 1/16 -CP
MAIN-P.W.Board			<a href="#">R1107</a>	06S15615Y33	RES,RK 221J 1/16 -CP
MAIN-P.W.Board			<a href="#">R1108</a>	06S15615Y89	RES,RK 473J 1/16 -CP
MAIN-P.W.Board			<a href="#">R1109</a>	06S15615Y89	RES,RK 473J 1/16 -CP
MAIN-P.W.Board			<a href="#">R1110</a>	06S15616Y18	RES,RK 684J 1/16 -CP

P.W.Board	MIS	MODEL	Ref.	Parts No.	Parts Name
MAIN-P.W.Board			<a href="#">R1111</a>	06S15615Y77	RES,RK 153J 1/16 -CP
MAIN-P.W.Board			<a href="#">R1112</a>	06S15615Y89	RES,RK 473J 1/16 -CP
MAIN-P.W.Board			<a href="#">R1113</a>	06S15615Y65	RES,RK 472J 1/16 -CP
MAIN-P.W.Board			<a href="#">R1114</a>	06S70072F90	RES,CP .1R0-J-1/4-CP
MAIN-P.W.Board			<a href="#">R1115</a>	06S15615Y91	RES,RK 563J 1/16 -CP
MAIN-P.W.Board			<a href="#">R1116</a>	06S15616Y23	RES,RK JUMPER1/16-CP
MAIN-P.W.Board			<a href="#">R1117</a>	06S15616Y23	RES,RK JUMPER1/16-CP
MAIN-P.W.Board			<a href="#">R1201</a>	06S15615Y89	RES,RK 473J 1/16 -CP
MAIN-P.W.Board			<a href="#">R1202</a>	06S15615Y89	RES,RK 473J 1/16 -CP
MAIN-P.W.Board			<a href="#">R1203</a>	06S15615Y89	RES,RK 473J 1/16 -CP
MAIN-P.W.Board			<a href="#">R1204</a>	06S15615Y89	RES,RK 473J 1/16 -CP
MAIN-P.W.Board			<a href="#">R1205</a>	06S15615Y89	RES,RK 473J 1/16 -CP
MAIN-P.W.Board			<a href="#">R1206</a>	06S15615Y89	RES,RK 473J 1/16 -CP
MAIN-P.W.Board			<a href="#">R1207</a>	06S15615Y89	RES,RK 473J 1/16 -CP
MAIN-P.W.Board			<a href="#">R1208</a>	06S45674W33	RES,RK 101J 1/10 -CP
MAIN-P.W.Board			<a href="#">R1209</a>	06S45674W33	RES,RK 101J 1/10 -CP
MAIN-P.W.Board			<a href="#">R1210</a>	06S15615Y65	RES,RK 472J 1/16 -CP
MAIN-P.W.Board			<a href="#">R1212</a>	06S15615Y81	RES,RK 223J 1/16 -CP
MAIN-P.W.Board			<a href="#">R1213</a>	06S15615Y81	RES,RK 223J 1/16 -CP
MAIN-P.W.Board			<a href="#">R1214</a>	06S15615Y77	RES,RK 153J 1/16 -CP
MAIN-P.W.Board			<a href="#">R1215</a>	06S15615Y77	RES,RK 153J 1/16 -CP
MAIN-P.W.Board			<a href="#">R1216</a>	06S45675W30	RES,RK 105J 1/10 -CP
MAIN-P.W.Board			<a href="#">R1217</a>	06S15615Y81	RES,RK 223J 1/16 -CP
MAIN-P.W.Board			<a href="#">R1218</a>	06S15615Y81	RES,RK 223J 1/16 -CP
MAIN-P.W.Board			<a href="#">R1219</a>	06S45674W33	RES,RK 101J 1/10 -CP
MAIN-P.W.Board			<a href="#">R1220</a>	06S15615Y89	RES,RK 473J 1/16 -CP
MAIN-P.W.Board			<a href="#">R1221</a>	06S15615Y89	RES,RK 473J 1/16 -CP
MAIN-P.W.Board			<a href="#">R1222</a>	06S15615Y89	RES,RK 473J 1/16 -CP
MAIN-P.W.Board			<a href="#">R1224</a>	06S15615Y89	RES,RK 473J 1/16 -CP
MAIN-P.W.Board			<a href="#">R1225</a>	06S15615Y89	RES,RK 473J 1/16 -CP
MAIN-P.W.Board			<a href="#">R1226</a>	06S15615Y89	RES,RK 473J 1/16 -CP
MAIN-P.W.Board			<a href="#">R1227</a>	06S15615Y89	RES,RK 473J 1/16 -CP
MAIN-P.W.Board			<a href="#">R1229</a>	06S15615Y73	RES,RK 103J 1/16 -CP
MAIN-P.W.Board			<a href="#">R1230</a>	06S15615Y43	RES,RK 561J 1/16 -CP
MAIN-P.W.Board			<a href="#">R1232</a>	06S15615Y89	RES,RK 473J 1/16 -CP
MAIN-P.W.Board			<a href="#">R1300</a>	06S15615Y89	RES,RK 473J 1/16 -CP
MAIN-P.W.Board			<a href="#">R1301</a>	06S15615Y83	RES,RK 273J 1/16 -CP
MAIN-P.W.Board			<a href="#">R1302</a>	06S15615Y25	RES,RK 101J 1/16 -CP
MAIN-P.W.Board			<a href="#">R1303</a>	06S15615Y91	RES,RK 563J 1/16 -CP
MAIN-P.W.Board			<a href="#">R1305</a>	06S15615Y63	RES,RK 392J 1/16 -CP
MAIN-P.W.Board			<a href="#">R1306</a>	06S15615Y25	RES,RK 101J 1/16 -CP
MAIN-P.W.Board			<a href="#">R1307</a>	06S15615Y89	RES,RK 473J 1/16 -CP
MAIN-P.W.Board			<a href="#">R1308</a>	06S15615Y81	RES,RK 223J 1/16 -CP
MAIN-P.W.Board			<a href="#">R1311</a>	06S15615Y67	RES,RK 562J 1/16 -CP
MAIN-P.W.Board			<a href="#">R1312</a>	06S15615Y67	RES,RK 562J 1/16 -CP

P.W.Board	MIS	MODEL	Ref.	Parts No.	Parts Name
MAIN-P.W.Board			<a href="#">R1313</a>	06S15615Y79	RES,RK 183J 1/16 -CP
MAIN-P.W.Board			<a href="#">R1314</a>	06S15615Y91	RES,RK 563J 1/16 -CP
MAIN-P.W.Board			<a href="#">R1315</a>	06S15615Y25	RES,RK 101J 1/16 -CP
MAIN-P.W.Board			<a href="#">R1316</a>	06S15615Y25	RES,RK 101J 1/16 -CP
MAIN-P.W.Board			<a href="#">R1317</a>	06S15615Y73	RES,RK 103J 1/16 -CP
MAIN-P.W.Board			<a href="#">R1318</a>	06S15615Y89	RES,RK 473J 1/16 -CP
MAIN-P.W.Board			<a href="#">R1319</a>	06S15615Y97	RES,RK 104J 1/16 -CP
MAIN-P.W.Board			<a href="#">R1320</a>	06S15615Y97	RES,RK 104J 1/16 -CP
MAIN-P.W.Board			<a href="#">R1321</a>	06S15615Y97	RES,RK 104J 1/16 -CP
MAIN-P.W.Board			<a href="#">R1322</a>	06S15615Y97	RES,RK 104J 1/16 -CP
MAIN-P.W.Board			<a href="#">R1800</a>	06S45675W43	RES,RK JUMPER1/10-CP
MAIN-P.W.Board			<a href="#">R1805</a>	06S45675W43	RES,RK JUMPER1/10-CP
MAIN-P.W.Board			<a href="#">R1807</a>	06S15615Y65	RES,RK 472J 1/16 -CP
MAIN-P.W.Board			<a href="#">R1808</a>	06S15593Y37	RES,RK 331F 1/10 -CP
MAIN-P.W.Board			<a href="#">R2100</a>	06S15593Y71	RES,RK 822F 1/10 -CP
MAIN-P.W.Board			<a href="#">R2101</a>	06S15593Y71	RES,RK 822F 1/10 -CP
MAIN-P.W.Board			<a href="#">R2102</a>	06S15593Y71	RES,RK 822F 1/10 -CP
MAIN-P.W.Board			<a href="#">R2103</a>	06S15593Y71	RES,RK 822F 1/10 -CP
MAIN-P.W.Board			<a href="#">R2104</a>	06S15615Y33	RES,RK 221J 1/16 -CP
MAIN-P.W.Board			<a href="#">R2105</a>	06S15615Y33	RES,RK 221J 1/16 -CP
MAIN-P.W.Board			<a href="#">R2400</a>	06S15593Y94	RES,RK 753F 1/10 -CP
MAIN-P.W.Board			<a href="#">R2401</a>	06S15593Y94	RES,RK 753F 1/10 -CP
MAIN-P.W.Board			<a href="#">R2402</a>	06S15593Y94	RES,RK 753F 1/10 -CP
MAIN-P.W.Board			<a href="#">R2403</a>	06S15593Y94	RES,RK 753F 1/10 -CP
MAIN-P.W.Board			<a href="#">R2404</a>	06S15593Y94	RES,RK 753F 1/10 -CP
MAIN-P.W.Board			<a href="#">R2405</a>	06S15593Y94	RES,RK 753F 1/10 -CP
MAIN-P.W.Board			<a href="#">R2406</a>	06S15593Y81	RES,RK 223F 1/10 -CP
MAIN-P.W.Board			<a href="#">R2407</a>	06S15593Y81	RES,RK 223F 1/10 -CP
MAIN-P.W.Board			<a href="#">R2408</a>	06S15593Y81	RES,RK 223F 1/10 -CP
MAIN-P.W.Board			<a href="#">R2409</a>	06S15593Y81	RES,RK 223F 1/10 -CP
MAIN-P.W.Board			<a href="#">R2410</a>	06S15593Y81	RES,RK 223F 1/10 -CP
MAIN-P.W.Board			<a href="#">R2411</a>	06S15593Y81	RES,RK 223F 1/10 -CP
MAIN-P.W.Board			<a href="#">R2412</a>	06S15593Y81	RES,RK 223F 1/10 -CP
MAIN-P.W.Board			<a href="#">R2413</a>	06S15593Y81	RES,RK 223F 1/10 -CP
MAIN-P.W.Board			<a href="#">R2414</a>	06S15593Y81	RES,RK 223F 1/10 -CP
MAIN-P.W.Board			<a href="#">R2415</a>	06S15593Y81	RES,RK 223F 1/10 -CP
MAIN-P.W.Board			<a href="#">R2416</a>	06S15593Y81	RES,RK 223F 1/10 -CP
MAIN-P.W.Board			<a href="#">R2417</a>	06S15593Y81	RES,RK 223F 1/10 -CP
MAIN-P.W.Board			<a href="#">R2424</a>	06S15593Y67	RES,RK 562F 1/10 -CP
MAIN-P.W.Board			<a href="#">R2425</a>	06S15593Y67	RES,RK 562F 1/10 -CP
MAIN-P.W.Board			<a href="#">R2426</a>	06S15593Y67	RES,RK 562F 1/10 -CP
MAIN-P.W.Board			<a href="#">R2427</a>	06S15593Y67	RES,RK 562F 1/10 -CP
MAIN-P.W.Board			<a href="#">R2428</a>	06S15593Y67	RES,RK 562F 1/10 -CP
MAIN-P.W.Board			<a href="#">R2429</a>	06S15593Y67	RES,RK 562F 1/10 -CP
MAIN-P.W.Board			<a href="#">R2430</a>	06S15593Y57	RES,RK 222F 1/10 -CP

P.W.Board	MIS	MODEL	Ref.	Parts No.	Parts Name
MAIN-P.W.Board			<a href="#">R2431</a>	06S15593Y57	RES,RK 222F 1/10 -CP
MAIN-P.W.Board			<a href="#">R2432</a>	06S15593Y57	RES,RK 222F 1/10 -CP
MAIN-P.W.Board			<a href="#">R2433</a>	06S15593Y57	RES,RK 222F 1/10 -CP
MAIN-P.W.Board			<a href="#">R2434</a>	06S15593Y57	RES,RK 222F 1/10 -CP
MAIN-P.W.Board			<a href="#">R2435</a>	06S15593Y57	RES,RK 222F 1/10 -CP
MAIN-P.W.Board			<a href="#">R2436</a>	06S15593Y73	RES,RK 103F 1/10 -CP
MAIN-P.W.Board			<a href="#">R2437</a>	06S15593Y73	RES,RK 103F 1/10 -CP
MAIN-P.W.Board			<a href="#">R2438</a>	06S15593Y73	RES,RK 103F 1/10 -CP
MAIN-P.W.Board			<a href="#">R2439</a>	06S15593Y73	RES,RK 103F 1/10 -CP
MAIN-P.W.Board			<a href="#">R2440</a>	06S15593Y73	RES,RK 103F 1/10 -CP
MAIN-P.W.Board			<a href="#">R2441</a>	06S15593Y73	RES,RK 103F 1/10 -CP
MAIN-P.W.Board			<a href="#">R2600</a>	06S55366Y10	RES,RK 683J 1/10 -CP
MAIN-P.W.Board			<a href="#">R2601</a>	06S55366Y10	RES,RK 683J 1/10 -CP
MAIN-P.W.Board			<a href="#">R2602</a>	06S55366Y10	RES,RK 683J 1/10 -CP
MAIN-P.W.Board			<a href="#">R2603</a>	06S55366Y10	RES,RK 683J 1/10 -CP
MAIN-P.W.Board			<a href="#">R2604</a>	06S55366Y10	RES,RK 683J 1/10 -CP
MAIN-P.W.Board			<a href="#">R2605</a>	06S55366Y10	RES,RK 683J 1/10 -CP
MAIN-P.W.Board			<a href="#">R2606</a>	06S55363Y49	RES,RK 221J 1/8 -CP
MAIN-P.W.Board			<a href="#">R2607</a>	06S55363Y49	RES,RK 221J 1/8 -CP
MAIN-P.W.Board			<a href="#">R2608</a>	06S55363Y49	RES,RK 221J 1/8 -CP
MAIN-P.W.Board			<a href="#">R2609</a>	06S55363Y49	RES,RK 221J 1/8 -CP
MAIN-P.W.Board			<a href="#">R2610</a>	06S55363Y49	RES,RK 221J 1/8 -CP
MAIN-P.W.Board			<a href="#">R2611</a>	06S55363Y49	RES,RK 221J 1/8 -CP
MAIN-P.W.Board			<a href="#">R2612</a>	06S55363Y41	RES,RK 101J 1/8 -CP
MAIN-P.W.Board			<a href="#">R2613</a>	06S55363Y41	RES,RK 101J 1/8 -CP
MAIN-P.W.Board			<a href="#">R2614</a>	06S55363Y41	RES,RK 101J 1/8 -CP
MAIN-P.W.Board			<a href="#">R2615</a>	06S55363Y41	RES,RK 101J 1/8 -CP
MAIN-P.W.Board			<a href="#">R2616</a>	06S55363Y41	RES,RK 101J 1/8 -CP
MAIN-P.W.Board			<a href="#">R2617</a>	06S55363Y41	RES,RK 101J 1/8 -CP
MAIN-P.W.Board			<a href="#">R5000</a>	06S45674W97	RES,RK 473J 1/10 -CP
MAIN-P.W.Board			<a href="#">R5001</a>	06S15616Y35	RES,RK 155J 1/16 -CP
MAIN-P.W.Board			<a href="#">R5002</a>	06S15616Y23	RES,RK JUMPER1/16-CP
MAIN-P.W.Board			<a href="#">R5003</a>	06S15615Y25	RES,RK 101J 1/16 -CP
MAIN-P.W.Board			<a href="#">R5004</a>	06S15615Y25	RES,RK 101J 1/16 -CP
MAIN-P.W.Board			<a href="#">R5005</a>	06S15615Y25	RES,RK 101J 1/16 -CP
MAIN-P.W.Board			<a href="#">R5006</a>	06S15615Y25	RES,RK 101J 1/16 -CP
MAIN-P.W.Board			<a href="#">R5007</a>	06S15615Y25	RES,RK 101J 1/16 -CP
MAIN-P.W.Board			<a href="#">R5008</a>	06S15615Y25	RES,RK 101J 1/16 -CP
MAIN-P.W.Board			<a href="#">R5009</a>	06S15615Y49	RES,RK 102J 1/16 -CP
MAIN-P.W.Board			<a href="#">R5010</a>	06S45674W81	RES,RK 103J 1/10 -CP
MAIN-P.W.Board			<a href="#">R5012</a>	06S45674W81	RES,RK 103J 1/10 -CP
MAIN-P.W.Board			<a href="#">R5014</a>	06S15615Y25	RES,RK 101J 1/16 -CP
MAIN-P.W.Board			<a href="#">R5015</a>	06S15615Y25	RES,RK 101J 1/16 -CP
MAIN-P.W.Board			<a href="#">R5016</a>	06S15615Y25	RES,RK 101J 1/16 -CP
MAIN-P.W.Board			<a href="#">R5017</a>	06S15615Y25	RES,RK 101J 1/16 -CP



P.W.Board	MIS	MODEL	Ref.	Parts No.	Parts Name
MAIN-P.W.Board			<a href="#">R5018</a>	06S15615Y25	RES,RK 101J 1/16 -CP
MAIN-P.W.Board			<a href="#">R5019</a>	06S15615Y25	RES,RK 101J 1/16 -CP
MAIN-P.W.Board			<a href="#">R5021</a>	06S45674W81	RES,RK 103J 1/10 -CP
MAIN-P.W.Board			<a href="#">R5023</a>	06S15615Y25	RES,RK 101J 1/16 -CP
MAIN-P.W.Board			<a href="#">R5025</a>	06S45674W97	RES,RK 473J 1/10 -CP
MAIN-P.W.Board			<a href="#">R5026</a>	06S45674W97	RES,RK 473J 1/10 -CP
MAIN-P.W.Board			<a href="#">R5027</a>	06S15615Y25	RES,RK 101J 1/16 -CP
MAIN-P.W.Board			<a href="#">R5034</a>	06S15615Y25	RES,RK 101J 1/16 -CP
MAIN-P.W.Board			<a href="#">R5035</a>	06S15615Y25	RES,RK 101J 1/16 -CP
MAIN-P.W.Board			<a href="#">R5036</a>	06S15615Y25	RES,RK 101J 1/16 -CP
MAIN-P.W.Board			<a href="#">R5037</a>	06S15615Y25	RES,RK 101J 1/16 -CP
MAIN-P.W.Board			<a href="#">R5039</a>	06S15615Y25	RES,RK 101J 1/16 -CP
MAIN-P.W.Board			<a href="#">R5040</a>	06S15615Y25	RES,RK 101J 1/16 -CP
MAIN-P.W.Board			<a href="#">R5041</a>	06S15615Y25	RES,RK 101J 1/16 -CP
MAIN-P.W.Board			<a href="#">R5042</a>	06S15615Y25	RES,RK 101J 1/16 -CP
MAIN-P.W.Board			<a href="#">R5043</a>	06S15615Y25	RES,RK 101J 1/16 -CP
MAIN-P.W.Board			<a href="#">R5044</a>	06S15615Y25	RES,RK 101J 1/16 -CP
MAIN-P.W.Board			<a href="#">R5045</a>	06S15615Y25	RES,RK 101J 1/16 -CP
MAIN-P.W.Board			<a href="#">R5046</a>	06S15615Y25	RES,RK 101J 1/16 -CP
MAIN-P.W.Board			<a href="#">R5047</a>	06S15615Y25	RES,RK 101J 1/16 -CP
MAIN-P.W.Board			<a href="#">R5050</a>	06S15615Y25	RES,RK 101J 1/16 -CP
MAIN-P.W.Board			<a href="#">R5051</a>	06S15615Y25	RES,RK 101J 1/16 -CP
MAIN-P.W.Board			<a href="#">R5052</a>	06S15615Y25	RES,RK 101J 1/16 -CP
MAIN-P.W.Board			<a href="#">R5053</a>	06S15615Y25	RES,RK 101J 1/16 -CP
MAIN-P.W.Board			<a href="#">R5054</a>	06S15615Y25	RES,RK 101J 1/16 -CP
MAIN-P.W.Board			<a href="#">R5055</a>	06S15615Y25	RES,RK 101J 1/16 -CP
MAIN-P.W.Board			<a href="#">R5056</a>	06S15615Y25	RES,RK 101J 1/16 -CP
MAIN-P.W.Board			<a href="#">R5058</a>	06S15615Y25	RES,RK 101J 1/16 -CP
MAIN-P.W.Board			<a href="#">R5059</a>	06S15615Y25	RES,RK 101J 1/16 -CP
MAIN-P.W.Board			<a href="#">R5061</a>	06S15615Y49	RES,RK 102J 1/16 -CP
MAIN-P.W.Board			<a href="#">R5062</a>	06S15615Y25	RES,RK 101J 1/16 -CP
MAIN-P.W.Board			<a href="#">R5063</a>	06S15615Y25	RES,RK 101J 1/16 -CP
MAIN-P.W.Board			<a href="#">R5064</a>	06S15615Y25	RES,RK 101J 1/16 -CP
MAIN-P.W.Board			<a href="#">R5065</a>	06S15615Y25	RES,RK 101J 1/16 -CP
MAIN-P.W.Board			<a href="#">R5066</a>	06S15615Y25	RES,RK 101J 1/16 -CP
MAIN-P.W.Board			<a href="#">R5067</a>	06S15615Y25	RES,RK 101J 1/16 -CP
MAIN-P.W.Board			<a href="#">R5068</a>	06S15615Y25	RES,RK 101J 1/16 -CP
MAIN-P.W.Board			<a href="#">R5071</a>	06S45674W41	RES,RK 221J 1/10 -CP
MAIN-P.W.Board			<a href="#">R5072</a>	06S45674W63	RES,RK 182J 1/10 -CP
MAIN-P.W.Board			<a href="#">R5073</a>	06S45674W63	RES,RK 182J 1/10 -CP
MAIN-P.W.Board			<a href="#">R5074</a>	06S15593Y49	RES,RK 102F 1/10 -CP
MAIN-P.W.Board			<a href="#">R5075</a>	06S15593Y81	RES,RK 223F 1/10 -CP
MAIN-P.W.Board			<a href="#">R5076</a>	06S15593Y37	RES,RK 331F 1/10 -CP
MAIN-P.W.Board			<a href="#">R5077</a>	06S15615Y25	RES,RK 101J 1/16 -CP
MAIN-P.W.Board			<a href="#">R5079</a>	06S15615Y25	RES,RK 101J 1/16 -CP



P.W.Board	MIS	MODEL	Ref.	Parts No.	Parts Name
MAIN-P.W.Board			<a href="#">R5082</a>	06S15615Y25	RES,RK 101J 1/16 -CP
MAIN-P.W.Board			<a href="#">R5088</a>	06S15615Y25	RES,RK 101J 1/16 -CP
MAIN-P.W.Board			<a href="#">R5089</a>	06S15615Y25	RES,RK 101J 1/16 -CP
MAIN-P.W.Board			<a href="#">R5091</a>	06S15615Y25	RES,RK 101J 1/16 -CP
MAIN-P.W.Board			<a href="#">R5094</a>	06S45674W57	RES,RK 102J 1/10 -CP
MAIN-P.W.Board			<a href="#">R5095</a>	06S45674W57	RES,RK 102J 1/10 -CP
MAIN-P.W.Board			<a href="#">R5096</a>	06S45674W97	RES,RK 473J 1/10 -CP
MAIN-P.W.Board			<a href="#">R5097</a>	06S45674W97	RES,RK 473J 1/10 -CP
MAIN-P.W.Board			<a href="#">R5098</a>	06S15593Y68	RES,RK 622F 1/10 -CP
MAIN-P.W.Board			<a href="#">R5200</a>	06S45675W43	RES,RK JUMPER1/10-CP
MAIN-P.W.Board			<a href="#">R5300</a>	06S45675W30	RES,RK 105J 1/10 -CP
MAIN-P.W.Board			<a href="#">R5301</a>	06S45675W30	RES,RK 105J 1/10 -CP
MAIN-P.W.Board			<a href="#">R5302</a>	06S45674W89	RES,RK 223J 1/10 -CP
MAIN-P.W.Board			<a href="#">R5303</a>	06S70072F29	RES,CP .101-J-1/4-CP
MAIN-P.W.Board			<a href="#">R5304</a>	06S45674W65	RES,RK 222J 1/10 -CP
MAIN-P.W.Board			<a href="#">R5305</a>	06S45674W69	RES,RK 332J 1/10 -CP
MAIN-P.W.Board			<a href="#">R5306</a>	06S45674W89	RES,RK 223J 1/10 -CP
MAIN-P.W.Board			<a href="#">R5307</a>	06S45674W57	RES,RK 102J 1/10 -CP
MAIN-P.W.Board			<a href="#">R5309</a>	06S64995F73	RES,RK 682J 1/8 -CP
MAIN-P.W.Board			<a href="#">R5400</a>	06S45674W97	RES,RK 473J 1/10 -CP
MAIN-P.W.Board			<a href="#">R5401</a>	06S45674W97	RES,RK 473J 1/10 -CP
MAIN-P.W.Board			<a href="#">R5402</a>	06S45674W97	RES,RK 473J 1/10 -CP
MAIN-P.W.Board			<a href="#">R5403</a>	06S45674W97	RES,RK 473J 1/10 -CP
MAIN-P.W.Board			<a href="#">R5404</a>	06S45674W97	RES,RK 473J 1/10 -CP
MAIN-P.W.Board			<a href="#">R5405</a>	06S45674W97	RES,RK 473J 1/10 -CP
MAIN-P.W.Board			<a href="#">R5406</a>	06S15615Y89	RES,RK 473J 1/16 -CP
MAIN-P.W.Board			<a href="#">R5500</a>	06S64995F53	RES,RK 102J 1/8 -CP
MAIN-P.W.Board			<a href="#">R5501</a>	06S65415Y41	RES,RK 223F 1/16 -CP
MAIN-P.W.Board			<a href="#">R5502</a>	06S65415Y41	RES,RK 223F 1/16 -CP
MAIN-P.W.Board			<a href="#">R5516</a>	06S15593Y81	RES,RK 223F 1/10 -CP
MAIN-P.W.Board			<a href="#">R5517</a>	06S45674W81	RES,RK 103J 1/10 -CP
MAIN-P.W.Board			<a href="#">R5518</a>	06S35095Y08	RES,RK JUMPER 1/4-CP
MAIN-P.W.Board			<a href="#">R5519</a>	06S15593Y81	RES,RK 223F 1/10 -CP
MAIN-P.W.Board			<a href="#">R5520</a>	06S15615Y89	RES,RK 473J 1/16 -CP
MAIN-P.W.Board			<a href="#">R5521</a>	06S64995F53	RES,RK 102J 1/8 -CP
MAIN-P.W.Board			<a href="#">R5522</a>	06S64995F53	RES,RK 102J 1/8 -CP
MAIN-P.W.Board			<a href="#">R5523</a>	06S64995F53	RES,RK 102J 1/8 -CP
MAIN-P.W.Board			<a href="#">R5524</a>	06S64995F53	RES,RK 102J 1/8 -CP
MAIN-P.W.Board			<a href="#">R5525</a>	06S35095Y08	RES,RK JUMPER 1/4-CP
MAIN-P.W.Board			<a href="#">R5526</a>	06S35095Y08	RES,RK JUMPER 1/4-CP
MAIN-P.W.Board			<a href="#">R5527</a>	06S45674W90	RES,RK 243J 1/10 -CP
MAIN-P.W.Board			<a href="#">R5528</a>	06S45674W65	RES,RK 222J 1/10 -CP
MAIN-P.W.Board			<a href="#">R5529</a>	06S55366Y07	RES,RK 513J 1/10 -CP
MAIN-P.W.Board			<a href="#">R5530</a>	06S64995F53	RES,RK 102J 1/8 -CP
MAIN-P.W.Board			<a href="#">R5532</a>	06S64995F53	RES,RK 102J 1/8 -CP

P.W.Board	MIS	MODEL	Ref.	Parts No.	Parts Name
MAIN-P.W.Board			<a href="#">R5533</a>	06S64995F53	RES,RK 102J 1/8 -CP
MAIN-P.W.Board			<a href="#">R6004</a>	06S15615Y25	RES,RK 101J 1/16 -CP
MAIN-P.W.Board			<a href="#">R6005</a>	06S15615Y25	RES,RK 101J 1/16 -CP
MAIN-P.W.Board			<a href="#">R6006</a>	06S15615Y25	RES,RK 101J 1/16 -CP
MAIN-P.W.Board			<a href="#">R6007</a>	06S15616Y28	RES,RK 3R3J 1/16 -CP
MAIN-P.W.Board			<a href="#">R6008</a>	06S15615Y48	RES,RK 911J 1/16 -CP
MAIN-P.W.Board			<a href="#">R6010</a>	06S15615Y48	RES,RK 911J 1/16 -CP
MAIN-P.W.Board			<a href="#">R6012</a>	06S15615Y48	RES,RK 911J 1/16 -CP
MAIN-P.W.Board			<a href="#">R6013</a>	06S15615Y25	RES,RK 101J 1/16 -CP
MAIN-P.W.Board			<a href="#">R6014</a>	06S15615Y48	RES,RK 911J 1/16 -CP
MAIN-P.W.Board			<a href="#">R6015</a>	06S15616Y23	RES,RK JUMPER1/16-CP
MAIN-P.W.Board			<a href="#">R6016</a>	06S65415Y11	RES,RK 68RF 1/16 -CP
MAIN-P.W.Board			<a href="#">R6017</a>	06S45348Y38	RES,RK 474F 1/4 -CP
MAIN-P.W.Board			<a href="#">R6018</a>	06S45348Y38	RES,RK 474F 1/4 -CP
MAIN-P.W.Board			<a href="#">R6019</a>	06S15615Y25	RES,RK 101J 1/16 -CP
MAIN-P.W.Board			<a href="#">R6022</a>	06S15615Y48	RES,RK 911J 1/16 -CP
MAIN-P.W.Board			<a href="#">R6023</a>	06S15615Y48	RES,RK 911J 1/16 -CP
MAIN-P.W.Board			<a href="#">R6024</a>	06S15615Y49	RES,RK 102J 1/16 -CP
MAIN-P.W.Board			<a href="#">R6026</a>	06S15615Y25	RES,RK 101J 1/16 -CP
MAIN-P.W.Board			<a href="#">R6028</a>	06S15615Y25	RES,RK 101J 1/16 -CP
MAIN-P.W.Board			<a href="#">R6029</a>	06S15615Y25	RES,RK 101J 1/16 -CP
MAIN-P.W.Board			<a href="#">R6030</a>	06S15615Y25	RES,RK 101J 1/16 -CP
MAIN-P.W.Board			<a href="#">R6031</a>	06S15615Y25	RES,RK 101J 1/16 -CP
MAIN-P.W.Board			<a href="#">R6032</a>	06S15615Y25	RES,RK 101J 1/16 -CP
MAIN-P.W.Board			<a href="#">R6033</a>	06S15615Y73	RES,RK 103J 1/16 -CP
MAIN-P.W.Board			<a href="#">R6034</a>	06S15615Y49	RES,RK 102J 1/16 -CP
MAIN-P.W.Board			<a href="#">R6035</a>	06S15615Y49	RES,RK 102J 1/16 -CP
MAIN-P.W.Board			<a href="#">R6036</a>	06S15615Y49	RES,RK 102J 1/16 -CP
MAIN-P.W.Board			<a href="#">R6037</a>	06S55363Y65	RES,RK 102J 1/8 -CP
MAIN-P.W.Board			<a href="#">R6038</a>	06S55363Y65	RES,RK 102J 1/8 -CP
MAIN-P.W.Board			<a href="#">R6039</a>	06S55363Y65	RES,RK 102J 1/8 -CP
MAIN-P.W.Board			<a href="#">R6040</a>	06S15615Y25	RES,RK 101J 1/16 -CP
MAIN-P.W.Board			<a href="#">R6041</a>	06S45674W73	RES,RK 472J 1/10 -CP
MAIN-P.W.Board			<a href="#">R6042</a>	06S45674W73	RES,RK 472J 1/10 -CP
MAIN-P.W.Board			<a href="#">R6043</a>	06S55363Y65	RES,RK 102J 1/8 -CP
MAIN-P.W.Board			<a href="#">R6201</a>	06S45674W33	RES,RK 101J 1/10 -CP
MAIN-P.W.Board			<a href="#">R7000</a>	06S45674W97	RES,RK 473J 1/10 -CP
MAIN-P.W.Board			<a href="#">R7001</a>	06S45674W97	RES,RK 473J 1/10 -CP
MAIN-P.W.Board			<a href="#">R7002</a>	06S45674W97	RES,RK 473J 1/10 -CP
MAIN-P.W.Board			<a href="#">R7003</a>	06S70072F53	RES,CP .102-J-1/4-CP
MAIN-P.W.Board			<a href="#">R7004</a>	06S70072F53	RES,CP .102-J-1/4-CP
MAIN-P.W.Board			<a href="#">R7005</a>	06S45674W97	RES,RK 473J 1/10 -CP
MAIN-P.W.Board			<a href="#">R7006</a>	06S70072F53	RES,CP .102-J-1/4-CP
MAIN-P.W.Board			<a href="#">R7007</a>	06S35095Y08	RES,RK JUMPER 1/4-CP
MAIN-P.W.Board			<a href="#">R7008</a>	06S35095Y08	RES,RK JUMPER 1/4-CP



P.W.Board	MIS	MODEL	Ref.	Parts No.	Parts Name
MAIN-P.W.Board			<a href="#">R7009</a>	06S35095Y08	RES,RK JUMPER 1/4-CP
MAIN-P.W.Board			<a href="#">R7100</a>	06S15615Y49	RES,RK 102J 1/16 -CP
MAIN-P.W.Board			<a href="#">R7101</a>	06S70072F53	RES,CP .102-J-1/4-CP
MAIN-P.W.Board			<a href="#">R7102</a>	06S70072F53	RES,CP .102-J-1/4-CP
MAIN-P.W.Board			<a href="#">R7103</a>	06S45674W73	RES,RK 472J 1/10 -CP
MAIN-P.W.Board			<a href="#">R7104</a>	06S45674W81	RES,RK 103J 1/10 -CP
MAIN-P.W.Board			<a href="#">R7105</a>	06S45674W33	RES,RK 101J 1/10 -CP
MAIN-P.W.Board			<a href="#">R7106</a>	06S45674W73	RES,RK 472J 1/10 -CP
MAIN-P.W.Board			<a href="#">R7109</a>	06S15615Y72	RES,RK 912J 1/16 -CP
MAIN-P.W.Board			<a href="#">R7110</a>	06S15615Y49	RES,RK 102J 1/16 -CP
MAIN-P.W.Board			<a href="#">R7111</a>	06S15615Y25	RES,RK 101J 1/16 -CP
MAIN-P.W.Board			<a href="#">R7112</a>	06S15615Y72	RES,RK 912J 1/16 -CP
MAIN-P.W.Board			<a href="#">R7113</a>	06S15615Y72	RES,RK 912J 1/16 -CP
MAIN-P.W.Board			<a href="#">R7300</a>	06S15615Y25	RES,RK 101J 1/16 -CP
MAIN-P.W.Board			<a href="#">R7301</a>	06S15615Y25	RES,RK 101J 1/16 -CP
MAIN-P.W.Board			<a href="#">R7302</a>	06S45675W43	RES,RK JUMPER1/10-CP
MAIN-P.W.Board			<a href="#">R7303</a>	06S15615Y25	RES,RK 101J 1/16 -CP
MAIN-P.W.Board			<a href="#">R7304</a>	06S15615Y49	RES,RK 102J 1/16 -CP
MAIN-P.W.Board			<a href="#">R7308</a>	06S15615Y73	RES,RK 103J 1/16 -CP
MAIN-P.W.Board			<a href="#">R7309</a>	06S15615Y73	RES,RK 103J 1/16 -CP
MAIN-P.W.Board			<a href="#">R7310</a>	06S45674W65	RES,RK 222J 1/10 -CP
MAIN-P.W.Board			<a href="#">R7311</a>	06S45674W90	RES,RK 243J 1/10 -CP
MAIN-P.W.Board			<a href="#">R8001</a>	06S45674W73	RES,RK 472J 1/10 -CP
MAIN-P.W.Board			<a href="#">R8002</a>	06S45674W73	RES,RK 472J 1/10 -CP
MAIN-P.W.Board			<a href="#">R8003</a>	06S15593Y84	RES,RK 303F 1/10 -CP
MAIN-P.W.Board			<a href="#">R8004</a>	06S15593Y83	RES,RK 273F 1/10 -CP
MAIN-P.W.Board			<a href="#">R8005</a>	06S55366Y11	RES,RK 753J 1/10 -CP
MAIN-P.W.Board			<a href="#">R8006</a>	06S15593Y65	RES,RK 472F 1/10 -CP
MAIN-P.W.Board			<a href="#">R8007</a>	06S45674W73	RES,RK 472J 1/10 -CP
MAIN-P.W.Board			<a href="#">R8008</a>	06S45674W81	RES,RK 103J 1/10 -CP
MAIN-P.W.Board			<a href="#">R8009</a>	06S70072F77	RES,CP .103-J-1/4-CP
MAIN-P.W.Board			<a href="#">R8010</a>	06S55365Y85	RES,RK 682J 1/10 -CP
MAIN-P.W.Board			<a href="#">R8011</a>	06S55366Y01	RES,RK 303J 1/10 -CP
MAIN-P.W.Board			<a href="#">R8013</a>	06S15593Y65	RES,RK 472F 1/10 -CP
MAIN-P.W.Board			<a href="#">R8014</a>	06S55365Y78	RES,RK 362J 1/10 -CP
MAIN-P.W.Board			<a href="#">R8015</a>	06S55365Y87	RES,RK 822J 1/10 -CP
MAIN-P.W.Board			<a href="#">R8016</a>	06S55365Y85	RES,RK 682J 1/10 -CP
MAIN-P.W.Board			<a href="#">R8017</a>	06S55366Y12	RES,RK 823J 1/10 -CP
MAIN-P.W.Board			<a href="#">R8018</a>	06S45674W65	RES,RK 222J 1/10 -CP
MAIN-P.W.Board			<a href="#">R8019</a>	06S45674W90	RES,RK 243J 1/10 -CP
MAIN-P.W.Board			<a href="#">R8020</a>	06S45675W06	RES,RK 104J 1/10 -CP
MAIN-P.W.Board			<a href="#">R8021</a>	06S45675W06	RES,RK 104J 1/10 -CP
MAIN-P.W.Board			<a href="#">R8022</a>	06S45348Y31	RES,RK 224F 1/4 -CP
MAIN-P.W.Board			<a href="#">R8023</a>	06S45348Y23	RES,RK 753F 1/4 -CP
MAIN-P.W.Board			<a href="#">R8024</a>	06S15593Y60	RES,RK 302F 1/10 -CP

P.W.Board	MIS	MODEL	Ref.	Parts No.	Parts Name
MAIN-P.W.Board			<a href="#">R8025</a>	06S65415Y61	RES,RK 105F 1/16 -CP
MAIN-P.W.Board			<a href="#">R8026</a>	06S45348Y09	RES,RK 512F 1/4 -CP
MAIN-P.W.Board			<a href="#">R8027</a>	06S35083Y25	RES,RK 102F 1/4 -CP
MAIN-P.W.Board			<a href="#">R8028</a>	06S45348Y06	RES,RK 302F 1/4 -CP
MAIN-P.W.Board			<a href="#">R8029</a>	06S45674W57	RES,RK 102J 1/10 -CP
MAIN-P.W.Board			<a href="#">R8031</a>	06S45674W81	RES,RK 103J 1/10 -CP
MAIN-P.W.Board			<a href="#">R8032</a>	06S45674W81	RES,RK 103J 1/10 -CP
MAIN-P.W.Board			<a href="#">R8033</a>	06S45674W97	RES,RK 473J 1/10 -CP
MAIN-P.W.Board			<a href="#">R8035</a>	06S45674W85	RES,RK 153J 1/10 -CP
MAIN-P.W.Board			<a href="#">R8036</a>	06S45674W33	RES,RK 101J 1/10 -CP
MAIN-P.W.Board			<a href="#">R8037</a>	06S45674W41	RES,RK 221J 1/10 -CP
MAIN-P.W.Board			<a href="#">R8039</a>	06S15593Y84	RES,RK 303F 1/10 -CP
MAIN-P.W.Board			<a href="#">R8040</a>	06S15593Y77	RES,RK 153F 1/10 -CP
MAIN-P.W.Board			<a href="#">R8041</a>	06S15593Y84	RES,RK 303F 1/10 -CP
MAIN-P.W.Board			<a href="#">R8043</a>	06S70072F77	RES,CP .103-J-1/4-CP
MAIN-P.W.Board			<a href="#">R8047</a>	06S45675W06	RES,RK 104J 1/10 -CP
MAIN-P.W.Board			<a href="#">R8049</a>	06S70072F29	RES,CP .101-J-1/4-CP
MAIN-P.W.Board			<a href="#">R8050</a>	06S70072F29	RES,CP .101-J-1/4-CP
MAIN-P.W.Board			<a href="#">R8099</a>	06S15615Y49	RES,RK 102J 1/16 -CP
MAIN-P.W.Board			<a href="#">R8100</a>	06S15615Y13	RES,RK 33RJ 1/16 -CP
MAIN-P.W.Board			<a href="#">R8102</a>	06S55365Y77	RES,RK 332J 1/10 -CP
MAIN-P.W.Board			<a href="#">R8103</a>	06S45674W57	RES,RK 102J 1/10 -CP
MAIN-P.W.Board			<a href="#">R8105</a>	06S15593Y73	RES,RK 103F 1/10 -CP
MAIN-P.W.Board			<a href="#">R8106</a>	06S15593Y77	RES,RK 153F 1/10 -CP
MAIN-P.W.Board			<a href="#">R8107</a>	06S15593Y51	RES,RK 122F 1/10 -CP
MAIN-P.W.Board			<a href="#">R8108</a>	06S45674W33	RES,RK 101J 1/10 -CP
MAIN-P.W.Board			<a href="#">R8109</a>	06S45675W04	RES,RK 823J 1/10 -CP
MAIN-P.W.Board			<a href="#">R8110</a>	06S55365Y85	RES,RK 682J 1/10 -CP
MAIN-P.W.Board			<a href="#">R8111</a>	06S55365Y41	RES,RK 101J 1/10 -CP
MAIN-P.W.Board			<a href="#">R8114</a>	06S55365Y41	RES,RK 101J 1/10 -CP
MAIN-P.W.Board			<a href="#">R8115</a>	06S15615Y49	RES,RK 102J 1/16 -CP
MAIN-P.W.Board			<a href="#">R8116</a>	06S45674W01	RES,RK 2R2J 1/10 -CP
MAIN-P.W.Board			<a href="#">R8123</a>	06S70072F47	RES,CP .561-J-1/4-CP
MAIN-P.W.Board			<a href="#">R8124</a>	06S45674W33	RES,RK 101J 1/10 -CP
MAIN-P.W.Board			<a href="#">R8126</a>	06S70072F35	RES,CP .181-J-1/4-CP
MAIN-P.W.Board			<a href="#">R8127</a>	06S70072F35	RES,CP .181-J-1/4-CP
MAIN-P.W.Board			<a href="#">R8128</a>	06S15593Y90	RES,RK 513F 1/10 -CP
MAIN-P.W.Board			<a href="#">R8129</a>	06S15593Y76	RES,RK 133F 1/10 -CP
MAIN-P.W.Board			<a href="#">R8133</a>	06S15593Y90	RES,RK 513F 1/10 -CP
MAIN-P.W.Board			<a href="#">R8134</a>	06S15593Y81	RES,RK 223F 1/10 -CP
MAIN-P.W.Board			<a href="#">R8137</a>	06S15593Y91	RES,RK 563F 1/10 -CP
MAIN-P.W.Board			<a href="#">R8138</a>	06S15593Y97	RES,RK 104F 1/10 -CP
MAIN-P.W.Board			<a href="#">RA1100</a>	06S15771Y45	RES,ARYEXB28V473J-CP
MAIN-P.W.Board			<a href="#">RA1101</a>	06S15771Y45	RES,ARYEXB28V473J-CP
MAIN-P.W.Board			<a href="#">RA1102</a>	06S15771Y33	RES,ARY 472J 4 -CP

P.W.Board	MIS	MODEL	Ref.	Parts No.	Parts Name
MAIN-P.W.Board			<a href="#">RA1103</a>	06S15771Y33	RES,ARY 472J 4 -CP
MAIN-P.W.Board			<a href="#">RA1104</a>	06S15771Y13	RES,ARYEXB28V101J-CP
MAIN-P.W.Board			<a href="#">RA1105</a>	06S15771Y13	RES,ARYEXB28V101J-CP
MAIN-P.W.Board			<a href="#">RA1106</a>	06S15771Y13	RES,ARYEXB28V101J-CP
MAIN-P.W.Board			<a href="#">RA1107</a>	06S15771Y13	RES,ARYEXB28V101J-CP
MAIN-P.W.Board			<a href="#">RA1200</a>	06S15771Y45	RES,ARYEXB28V473J-CP
MAIN-P.W.Board			<a href="#">RA1201</a>	06S15771Y13	RES,ARYEXB28V101J-CP
MAIN-P.W.Board			<a href="#">RA1202</a>	06S15771Y13	RES,ARYEXB28V101J-CP
MAIN-P.W.Board			<a href="#">RA1203</a>	06S15771Y45	RES,ARYEXB28V473J-CP
MAIN-P.W.Board			<a href="#">RA1207</a>	06S15771Y45	RES,ARYEXB28V473J-CP
MAIN-P.W.Board			<a href="#">RA1208</a>	06S15771Y13	RES,ARYEXB28V101J-CP
MAIN-P.W.Board			<a href="#">RA1209</a>	06S15771Y13	RES,ARYEXB28V101J-CP
MAIN-P.W.Board			<a href="#">RA1210</a>	06S15771Y45	RES,ARYEXB28V473J-CP
MAIN-P.W.Board			<a href="#">RA1211</a>	06S15771Y13	RES,ARYEXB28V101J-CP
MAIN-P.W.Board			<a href="#">RA5000</a>	06S15771Y13	RES,ARYEXB28V101J-CP
MAIN-P.W.Board			<a href="#">RA5001</a>	06S15771Y13	RES,ARYEXB28V101J-CP
MAIN-P.W.Board			<a href="#">SA6001</a>	48-00954Z03	VST,CSA30-401Q-T -CP
MAIN-P.W.Board			<a href="#">SD2500</a>	48T35138Y01	DIO,SHT RB160L-40-E1
MAIN-P.W.Board			<a href="#">SD2501</a>	48-22179Z01	DIO,SHT DB3X313F0LCP
MAIN-P.W.Board			<a href="#">SD8000</a>	48-16710Z01	DIO,SHT RB530S-30-CP
MAIN-P.W.Board			<a href="#">SD8006</a>	48-16700Z01	DIO,SHT RSX501LA -E1
MAIN-P.W.Board			<a href="#">SW5000</a>	40T16096W03	SW ,TACT SKHHLW
MAIN-P.W.Board			<a href="#">TH5000</a>	48T25250Y06	TMT,ERTJ1VR223G -CP
MAIN-P.W.Board			<a href="#">VR8100</a>	18-12468Z11	VAR,EVM2NSX80 224-CP
MAIN-P.W.Board			<a href="#">VT6001</a>	24-03457Z02	COIL,RF FM 5CCE -E6
MAIN-P.W.Board			<a href="#">VT8000</a>	24-02502Z02	ASSY,W277A001 -DB
MAIN-P.W.Board			<a href="#">XL1100</a>	91-15988Z11	XTL,NX3225GA 16.9-CP
MAIN-P.W.Board			<a href="#">XL1200</a>	91-14119Z03	XTL,XQ 9.000M -E5
MAIN-P.W.Board			<a href="#">XL1201</a>	91-16093Z01	XTL,NX3215SA 32.7-E1
MAIN-P.W.Board			<a href="#">XL5000</a>	91-16093Z01	XTL,NX3215SA 32.7-E1
MAIN-P.W.Board			<a href="#">XL5001</a>	91-16024Z06	XTL,AT-41CD2 12.0-E9
MAIN-P.W.Board			<a href="#">XL6001</a>	91-17642Z22	XTL,NX3225SA 62.4-CP
MAIN-P.W.Board			<a href="#">Z1100</a>	91T75196Y08	EMI,BK1005HW601 -CP
MAIN-P.W.Board			<a href="#">Z1101</a>	24T95459W07	FBI,BLM41PG102SH1-E1
MAIN-P.W.Board			<a href="#">ZD5500</a>	48-18196Z02	DIO,ZEN DZ2S051M0LCP
MAIN-P.W.Board			<a href="#">ZD5501</a>	48-18196Z02	DIO,ZEN DZ2S051M0LCP
MAIN-P.W.Board			<a href="#">ZD7000</a>	48-21149Z23	DIO,ZEN DZ2J056M0LCP
MAIN-P.W.Board			<a href="#">ZD7001</a>	48-21149Z23	DIO,ZEN DZ2J056M0LCP
MAIN-P.W.Board			<a href="#">ZD7002</a>	48-21149Z23	DIO,ZEN DZ2J056M0LCP
MAIN-P.W.Board			<a href="#">ZD8000</a>	48-07043Z37	DIO,ZEN KDZ11V -CP
MAIN-P.W.Board			<a href="#">ZD8001</a>	48-02592Z01	DIO,ZEN Z5W27VJ -EA
MAIN-P.W.Board			<a href="#">ZD8003</a>	48-21149Z42	DIO,ZEN DZ2J100H0LCP
MAIN-P.W.Board			<a href="#">ZD8004</a>	48-21149Z26	DIO,ZEN DZ2J062M0LCP
FRONT-P.W.Board			<a href="#">C400</a>	08S45676W85	CAP,CER 104K-B1C -CP
FRONT-P.W.Board			<a href="#">C401</a>	08S65667Y03	CAP,CER 474KX5R1A-CP



P.W.Board	MIS	MODEL	Ref.	Parts No.	Parts Name
FRONT-P.W.Board			<a href="#">C402</a>	08S45232Y15	CAP,CER 473K-B1A -CP
FRONT-P.W.Board			<a href="#">C403</a>	08S45232Y15	CAP,CER 473K-B1A -CP
FRONT-P.W.Board			<a href="#">C404</a>	08S45231Y37	CAP,CER 821J-CH1E-CP
FRONT-P.W.Board			<a href="#">C405</a>	08S65667Y03	CAP,CER 474KX5R1A-CP
FRONT-P.W.Board			<a href="#">C406</a>	08S45676W80	CAP,CER 223K-B1E -CP
FRONT-P.W.Board			<a href="#">C408</a>	08S45676W80	CAP,CER 223K-B1E -CP
FRONT-P.W.Board			<a href="#">C409</a>	08S35374W12	CAP,CER 106K-B0J -CP
FRONT-P.W.Board			<a href="#">C412</a>	08S45676W60	CAP,CER.102J-SL1H-CP
FRONT-P.W.Board			<a href="#">C414</a>	08S45232Y05	CAP,CER 102K-B1H -CP
FRONT-P.W.Board			<a href="#">C417</a>	08S35374W12	CAP,CER 106K-B0J -CP
FRONT-P.W.Board			<a href="#">CB460</a>	09-18716Z01	BTB,DF20-P -EJ
FRONT-P.W.Board			<a href="#">D400</a>	48-12230Z01	DIO,KDS226-RTK -CP
FRONT-P.W.Board			<a href="#">D401</a>	48-07015Z01	DIO,KDS160-RTK -CP
FRONT-P.W.Board			<a href="#">D402</a>	48T94471F04	DIO,IMN10-T108 -CP
FRONT-P.W.Board			<a href="#">D403</a>	48-05472Z01	DIO,1SS272-L -CP
FRONT-P.W.Board			<a href="#">D407</a>	48-12230Z01	DIO,KDS226-RTK -CP
FRONT-P.W.Board			<a href="#">D408</a>	48-12230Z01	DIO,KDS226-RTK -CP
FRONT-P.W.Board			<a href="#">D409</a>	48-12230Z01	DIO,KDS226-RTK -CP
FRONT-P.W.Board			<a href="#">D410</a>	48-12230Z01	DIO,KDS226-RTK -CP
FRONT-P.W.Board			<a href="#">D412</a>	48-07015Z01	DIO,KDS160-RTK -CP
FRONT-P.W.Board			<a href="#">D413</a>	48-07015Z01	DIO,KDS160-RTK -CP
FRONT-P.W.Board			<a href="#">D414</a>	48-07015Z01	DIO,KDS160-RTK -CP
FRONT-P.W.Board			<a href="#">D415</a>	48-07015Z01	DIO,KDS160-RTK -CP
FRONT-P.W.Board			<a href="#">D416</a>	48-07015Z01	DIO,KDS160-RTK -CP
FRONT-P.W.Board			<a href="#">IC401</a>	51T02347K01	PT6583LQ(L) -QT
FRONT-P.W.Board			<a href="#">IC500</a>	51-18623Z01	PNJ4L02M -NE1
FRONT-P.W.Board			<a href="#">JK400</a>	09-18872Z01	JAC,1850383000322-DB
FRONT-P.W.Board			<a href="#">LCD401</a>	65-21705Z01	LCD,TF5935M0TTN-FZ
FRONT-P.W.Board			<a href="#">LD400</a>	48-13928Z01	LED,ARY QB.L.021 -DB
FRONT-P.W.Board			<a href="#">LD401</a>	48-14200Z02	LED,BLU LNJ926W8C-CP
FRONT-P.W.Board			<a href="#">LD402</a>	48-14200Z02	LED,BLU LNJ926W8C-CP
FRONT-P.W.Board			<a href="#">LD405</a>	48-14200Z02	LED,BLU LNJ926W8C-CP
FRONT-P.W.Board			<a href="#">LD406</a>	48-14200Z02	LED,BLU LNJ926W8C-CP
FRONT-P.W.Board			<a href="#">LD409</a>	48-14200Z02	LED,BLU LNJ926W8C-CP
FRONT-P.W.Board			<a href="#">LD410</a>	48-14200Z02	LED,BLU LNJ926W8C-CP
FRONT-P.W.Board			<a href="#">LD411</a>	48-14200Z02	LED,BLU LNJ926W8C-CP
FRONT-P.W.Board			<a href="#">LD412</a>	48-14200Z02	LED,BLU LNJ926W8C-CP
FRONT-P.W.Board			<a href="#">LD413</a>	48-14200Z02	LED,BLU LNJ926W8C-CP
FRONT-P.W.Board			<a href="#">LD414</a>	48-14200Z02	LED,BLU LNJ926W8C-CP
FRONT-P.W.Board			<a href="#">LD415</a>	48-14200Z02	LED,BLU LNJ926W8C-CP
FRONT-P.W.Board			<a href="#">LD417</a>	48-14200Z02	LED,BLU LNJ926W8C-CP
FRONT-P.W.Board			<a href="#">LD418</a>	48-14200Z02	LED,BLU LNJ926W8C-CP
FRONT-P.W.Board			<a href="#">LD419</a>	48-14200Z02	LED,BLU LNJ926W8C-CP
FRONT-P.W.Board			<a href="#">LD420</a>	48-14200Z02	LED,BLU LNJ926W8C-CP
FRONT-P.W.Board			<a href="#">LD421</a>	48-14200Z02	LED,BLU LNJ926W8C-CP

P.W.Board	MIS	MODEL	Ref.	Parts No.	Parts Name
FRONT-P.W.Board			<a href="#">LD424</a>	48-14200Z02	LED,BLU LNJ926W8C-CP
FRONT-P.W.Board			<a href="#">LD425</a>	48-14200Z02	LED,BLU LNJ926W8C-CP
FRONT-P.W.Board			<a href="#">Q400</a>	48-13059Z01	TR,KTC2875-B-RTK -CP
FRONT-P.W.Board			<a href="#">Q404</a>	48-13059Z01	TR,KTC2875-B-RTK -CP
FRONT-P.W.Board			<a href="#">Q405</a>	48-19949Z01	TR,DRC5143X -CP
FRONT-P.W.Board			<a href="#">Q406</a>	48-17549Z01	TR,DSC500100L -CP
FRONT-P.W.Board			<a href="#">Q407</a>	48-13059Z01	TR,KTC2875-B-RTK -CP
FRONT-P.W.Board			<a href="#">R400</a>	06S45675W43	RES,RK JUMPER1/10-CP
FRONT-P.W.Board			<a href="#">R401</a>	06S45674W65	RES,RK 222J 1/10 -CP
FRONT-P.W.Board			<a href="#">R402</a>	06S45674W81	RES,RK 103J 1/10 -CP
FRONT-P.W.Board			<a href="#">R403</a>	06S70072F50	RES,CP .751-J-1/4-CP
FRONT-P.W.Board			<a href="#">R408</a>	06S70072F47	RES,CP .561-J-1/4-CP
FRONT-P.W.Board			<a href="#">R409</a>	06S45674W65	RES,RK 222J 1/10 -CP
FRONT-P.W.Board			<a href="#">R410</a>	06S70072F47	RES,CP .561-J-1/4-CP
FRONT-P.W.Board			<a href="#">R411</a>	06S45674W61	RES,RK 152J 1/10 -CP
FRONT-P.W.Board			<a href="#">R412</a>	06S15593Y93	RES,RK 683F 1/10 -CP
FRONT-P.W.Board			<a href="#">R413</a>	06S45674W57	RES,RK 102J 1/10 -CP
FRONT-P.W.Board			<a href="#">R414</a>	06S15593Y87	RES,RK 393F 1/10 -CP
FRONT-P.W.Board			<a href="#">R415</a>	06S45674W97	RES,RK 473J 1/10 -CP
FRONT-P.W.Board			<a href="#">R416</a>	06S45674W57	RES,RK 102J 1/10 -CP
FRONT-P.W.Board			<a href="#">R417</a>	06S45674W73	RES,RK 472J 1/10 -CP
FRONT-P.W.Board			<a href="#">R418</a>	06S45674W97	RES,RK 473J 1/10 -CP
FRONT-P.W.Board			<a href="#">R419</a>	06S45674W97	RES,RK 473J 1/10 -CP
FRONT-P.W.Board			<a href="#">R420</a>	06S45674W97	RES,RK 473J 1/10 -CP
FRONT-P.W.Board			<a href="#">R421</a>	06S45674W97	RES,RK 473J 1/10 -CP
FRONT-P.W.Board			<a href="#">R422</a>	06S70072F41	RES,CP .331-J-1/4-CP
FRONT-P.W.Board			<a href="#">R423</a>	06S70072F41	RES,CP .331-J-1/4-CP
FRONT-P.W.Board			<a href="#">R424</a>	06S70072F33	RES,CP .151-J-1/4-CP
FRONT-P.W.Board			<a href="#">R425</a>	06S70072F41	RES,CP .331-J-1/4-CP
FRONT-P.W.Board			<a href="#">R428</a>	06S70072F47	RES,CP .561-J-1/4-CP
FRONT-P.W.Board			<a href="#">R431</a>	06S45674W73	RES,RK 472J 1/10 -CP
FRONT-P.W.Board			<a href="#">R433</a>	06S70072F45	RES,CP .471-J-1/4-CP
FRONT-P.W.Board			<a href="#">R434</a>	06S70072F41	RES,CP .331-J-1/4-CP
FRONT-P.W.Board			<a href="#">R437</a>	06S64995F53	RES,RK 102J 1/8 -CP
FRONT-P.W.Board			<a href="#">R438</a>	06S64995F53	RES,RK 102J 1/8 -CP
FRONT-P.W.Board			<a href="#">R444</a>	06S70072F63	RES,CP .272-J-1/4-CP
FRONT-P.W.Board			<a href="#">R447</a>	06S70072F54	RES,CP .112-J-1/4-CP
FRONT-P.W.Board			<a href="#">R448</a>	06S70072F47	RES,CP .561-J-1/4-CP
FRONT-P.W.Board			<a href="#">R450</a>	06S64995F53	RES,RK 102J 1/8 -CP
FRONT-P.W.Board			<a href="#">R451</a>	06S64995F53	RES,RK 102J 1/8 -CP
FRONT-P.W.Board			<a href="#">R452</a>	06S64995F53	RES,RK 102J 1/8 -CP
FRONT-P.W.Board			<a href="#">R453</a>	06S64995F53	RES,RK 102J 1/8 -CP
FRONT-P.W.Board			<a href="#">R457</a>	06S70072F29	RES,CP .101-J-1/4-CP
FRONT-P.W.Board			<a href="#">R458</a>	06S45674W81	RES,RK 103J 1/10 -CP
FRONT-P.W.Board			<a href="#">R460</a>	06S65415Y25	RES,RK 102F 1/16 -CP



P.W.Board	MIS	MODEL	Ref.	Parts No.	Parts Name
FRONT-P.W.Board			<a href="#">R461</a>	06S70072F17	RES,CP .33R-J-1/4-CP
FRONT-P.W.Board			<a href="#">R462</a>	06S70072F17	RES,CP .33R-J-1/4-CP
FRONT-P.W.Board			<a href="#">R463</a>	06S65415Y25	RES,RK 102F 1/16 -CP
FRONT-P.W.Board			<a href="#">R464</a>	06S65415Y25	RES,RK 102F 1/16 -CP
FRONT-P.W.Board			<a href="#">R465</a>	06S70072F45	RES,CP .471-J-1/4-CP
FRONT-P.W.Board			<a href="#">R466</a>	06S64995F53	RES,RK 102J 1/8 -CP
FRONT-P.W.Board			<a href="#">R467</a>	06S64995F21	RES,RK 47RJ 1/8 -CP
FRONT-P.W.Board			<a href="#">R468</a>	06S35095Y08	RES,RK JUMPER 1/4-CP
FRONT-P.W.Board			<a href="#">R469</a>	06S70072F54	RES,CP .112-J-1/4-CP
FRONT-P.W.Board			<a href="#">R471</a>	06S70072F21	RES,CP .47R-J-1/4-CP
FRONT-P.W.Board			<a href="#">RA401</a>	06S15771Y25	RES,ARYEXB28V102J-CP
FRONT-P.W.Board			<a href="#">RA402</a>	06S15771Y25	RES,ARYEXB28V102J-CP
FRONT-P.W.Board			<a href="#">RA403</a>	06S15771Y25	RES,ARYEXB28V102J-CP
FRONT-P.W.Board			<a href="#">SK400</a>	09-19382Z01	SKT,CM-V105 -DB
FRONT-P.W.Board			<a href="#">SW400</a>	40T65353Y01	SW,TACT SKRSPACE010E2
FRONT-P.W.Board			<a href="#">SW401</a>	40T65353Y01	SW,TACT SKRSPACE010E2
FRONT-P.W.Board			<a href="#">SW402</a>	40T65353Y01	SW,TACT SKRSPACE010E2
FRONT-P.W.Board			<a href="#">SW404</a>	40T65353Y01	SW,TACT SKRSPACE010E2
FRONT-P.W.Board			<a href="#">SW406</a>	40T65353Y01	SW,TACT SKRSPACE010E2
FRONT-P.W.Board			<a href="#">SW407</a>	40T65353Y01	SW,TACT SKRSPACE010E2
FRONT-P.W.Board			<a href="#">SW408</a>	40T65353Y01	SW,TACT SKRSPACE010E2
FRONT-P.W.Board			<a href="#">SW409</a>	40T65353Y01	SW,TACT SKRSPACE010E2
FRONT-P.W.Board			<a href="#">SW410</a>	40T65353Y01	SW,TACT SKRSPACE010E2
FRONT-P.W.Board			<a href="#">SW411</a>	40T65353Y01	SW,TACT SKRSPACE010E2
FRONT-P.W.Board			<a href="#">SW412</a>	40T65353Y01	SW,TACT SKRSPACE010E2
FRONT-P.W.Board			<a href="#">SW413</a>	40T65353Y01	SW,TACT SKRSPACE010E2
FRONT-P.W.Board			<a href="#">SW415</a>	40T65353Y01	SW,TACT SKRSPACE010E2
FRONT-P.W.Board			<a href="#">SW416</a>	40T65353Y01	SW,TACT SKRSPACE010E2
FRONT-P.W.Board			<a href="#">SW417</a>	40T65353Y01	SW,TACT SKRSPACE010E2
FRONT-P.W.Board			<a href="#">SW418</a>	40-10735Z02	ENC,EC12D1524405 -DB
FRONT-P.W.Board			<a href="#">SW419</a>	40T65353Y01	SW,TACT SKRSPACE010E2
FRONT-P.W.Board			<a href="#">Z401</a>	91-14147Z01	EMI,ACM2012H-900 -CP
FRONT-P.W.Board			<a href="#">ZD402</a>	48-21149Z19	DIO,ZEN DZ2J051L0LCP
FRONT-P.W.Board			<a href="#">ZD403</a>	48-18196Z02	DIO,ZEN DZ2S051M0LCP
FRONT-P.W.Board			<a href="#">ZD404</a>	48-18196Z02	DIO,ZEN DZ2S051M0LCP
HD.RADIO-P.W.Board			<a href="#">C1</a>	08S45231Y05	CAP,CER 2R0C-CK1H-CP
HD.RADIO-P.W.Board			<a href="#">C10</a>	08S45232Y21	CAP,CER 104K-B1ACP
HD.RADIO-P.W.Board			<a href="#">C11</a>	08S45232Y21	CAP,CER 104K-B1ACP
HD.RADIO-P.W.Board			<a href="#">C12</a>	08S45232Y21	CAP,CER 104K-B1ACP
HD.RADIO-P.W.Board			<a href="#">C13</a>	08S45232Y21	CAP,CER 104K-B1ACP
HD.RADIO-P.W.Board			<a href="#">C14</a>	08S45232Y21	CAP,CER 104K-B1ACP
HD.RADIO-P.W.Board			<a href="#">C15</a>	08S45232Y21	CAP,CER 104K-B1ACP
HD.RADIO-P.W.Board			<a href="#">C16</a>	08S45232Y21	CAP,CER 104K-B1ACP
HD.RADIO-P.W.Board			<a href="#">C17</a>	08S45232Y21	CAP,CER 104K-B1ACP
HD.RADIO-P.W.Board			<a href="#">C18</a>	08S45232Y21	CAP,CER 104K-B1ACP

P.W.Board	MIS	MODEL	Ref.	Parts No.	Parts Name
HD.RADIO-P.W.Board			<a href="#">C19</a>	08S45232Y21	CAP,CER 104K-B1ACP
HD.RADIO-P.W.Board			<a href="#">C2</a>	08S45231Y05	CAP,CER 2R0C-CK1H-CP
HD.RADIO-P.W.Board			<a href="#">C20</a>	08S45232Y21	CAP,CER 104K-B1ACP
HD.RADIO-P.W.Board			<a href="#">C21</a>	08S45232Y21	CAP,CER 104K-B1ACP
HD.RADIO-P.W.Board			<a href="#">C22</a>	08S45232Y21	CAP,CER 104K-B1ACP
HD.RADIO-P.W.Board			<a href="#">C23</a>	08S45232Y21	CAP,CER 104K-B1ACP
HD.RADIO-P.W.Board			<a href="#">C24</a>	08S45232Y21	CAP,CER 104K-B1ACP
HD.RADIO-P.W.Board			<a href="#">C25</a>	08S45232Y21	CAP,CER 104K-B1ACP
HD.RADIO-P.W.Board			<a href="#">C26</a>	08S45232Y21	CAP,CER 104K-B1ACP
HD.RADIO-P.W.Board			<a href="#">C27</a>	08S45232Y21	CAP,CER 104K-B1ACP
HD.RADIO-P.W.Board			<a href="#">C28</a>	08S45232Y21	CAP,CER 104K-B1ACP
HD.RADIO-P.W.Board			<a href="#">C29</a>	08S45232Y21	CAP,CER 104K-B1ACP
HD.RADIO-P.W.Board			<a href="#">C3</a>	08S45232Y21	CAP,CER 104K-B1ACP
HD.RADIO-P.W.Board			<a href="#">C30</a>	08S45232Y21	CAP,CER 104K-B1ACP
HD.RADIO-P.W.Board			<a href="#">C31</a>	08S45232Y21	CAP,CER 104K-B1ACP
HD.RADIO-P.W.Board			<a href="#">C32</a>	08S45232Y21	CAP,CER 104K-B1ACP
HD.RADIO-P.W.Board			<a href="#">C33</a>	08S45232Y21	CAP,CER 104K-B1ACP
HD.RADIO-P.W.Board			<a href="#">C34</a>	08S45232Y21	CAP,CER 104K-B1ACP
HD.RADIO-P.W.Board			<a href="#">C35</a>	08S45232Y21	CAP,CER 104K-B1ACP
HD.RADIO-P.W.Board			<a href="#">C36</a>	08S45232Y21	CAP,CER 104K-B1ACP
HD.RADIO-P.W.Board			<a href="#">C37</a>	08S45232Y21	CAP,CER 104K-B1ACP
HD.RADIO-P.W.Board			<a href="#">C38</a>	08S45232Y21	CAP,CER 104K-B1ACP
HD.RADIO-P.W.Board			<a href="#">C39</a>	08S45232Y21	CAP,CER 104K-B1ACP
HD.RADIO-P.W.Board			<a href="#">C4</a>	08S45232Y21	CAP,CER 104K-B1ACP
HD.RADIO-P.W.Board			<a href="#">C40</a>	08S65667Y05	CAP,CER 105KX5R1A-CP
HD.RADIO-P.W.Board			<a href="#">C41</a>	08S45232Y21	CAP,CER 104K-B1ACP
HD.RADIO-P.W.Board			<a href="#">C42</a>	08S65667Y05	CAP,CER 105KX5R1A-CP
HD.RADIO-P.W.Board			<a href="#">C43</a>	08S45232Y21	CAP,CER 104K-B1ACP
HD.RADIO-P.W.Board			<a href="#">C44</a>	08S35374W12	CAP,CER 106K-B0J -CP
HD.RADIO-P.W.Board			<a href="#">C45</a>	08S45232Y21	CAP,CER 104K-B1ACP
HD.RADIO-P.W.Board			<a href="#">C46</a>	08S35374W12	CAP,CER 106K-B0J -CP
HD.RADIO-P.W.Board			<a href="#">C47</a>	08S45232Y21	CAP,CER 104K-B1ACP
HD.RADIO-P.W.Board			<a href="#">C48</a>	08S35374W12	CAP,CER 106K-B0J -CP
HD.RADIO-P.W.Board			<a href="#">C49</a>	08S45232Y21	CAP,CER 104K-B1ACP
HD.RADIO-P.W.Board			<a href="#">C5</a>	08S45232Y21	CAP,CER 104K-B1ACP
HD.RADIO-P.W.Board			<a href="#">C50</a>	08S35374W12	CAP,CER 106K-B0J -CP
HD.RADIO-P.W.Board			<a href="#">C51</a>	08S45232Y21	CAP,CER 104K-B1ACP
HD.RADIO-P.W.Board			<a href="#">C52</a>	08S35374W12	CAP,CER 106K-B0J -CP
HD.RADIO-P.W.Board			<a href="#">C53</a>	08S45232Y21	CAP,CER 104K-B1ACP
HD.RADIO-P.W.Board			<a href="#">C54</a>	08S35374W12	CAP,CER 106K-B0J -CP
HD.RADIO-P.W.Board			<a href="#">C55</a>	08S45232Y21	CAP,CER 104K-B1ACP
HD.RADIO-P.W.Board			<a href="#">C56</a>	08S45232Y21	CAP,CER 104K-B1ACP
HD.RADIO-P.W.Board			<a href="#">C57</a>	08S65667Y05	CAP,CER 105KX5R1A-CP
HD.RADIO-P.W.Board			<a href="#">C58</a>	08S65667Y05	CAP,CER 105KX5R1A-CP
HD.RADIO-P.W.Board			<a href="#">C59</a>	08S35374W12	CAP,CER 106K-B0J -CP

P.W.Board	MIS	MODEL	Ref.	Parts No.	Parts Name
HD.RADIO-P.W.Board			<a href="#">C6</a>	08S45232Y21	CAP,CER 104K-B1ACP
HD.RADIO-P.W.Board			<a href="#">C60</a>	08S45232Y21	CAP,CER 104K-B1ACP
HD.RADIO-P.W.Board			<a href="#">C61</a>	08S45232Y21	CAP,CER 104K-B1ACP
HD.RADIO-P.W.Board			<a href="#">C62</a>	08S35374W12	CAP,CER 106K-B0J -CP
HD.RADIO-P.W.Board			<a href="#">C63</a>	08S45231Y38	CAP,CER 102J-CH1E-CP
HD.RADIO-P.W.Board			<a href="#">C7</a>	08S45232Y21	CAP,CER 104K-B1ACP
HD.RADIO-P.W.Board			<a href="#">C8</a>	08S45232Y21	CAP,CER 104K-B1ACP
HD.RADIO-P.W.Board			<a href="#">C9</a>	08S45232Y21	CAP,CER 104K-B1ACP
HD.RADIO-P.W.Board			<a href="#">CB1</a>	09-21760Z01	PIN,IMSA9224B-32Z-DB
HD.RADIO-P.W.Board			<a href="#">E1</a>	23-09405Z06	CAP,CX 391-0D -E2
HD.RADIO-P.W.Board			<a href="#">E2</a>	23-09405Z12	CAP,CX 151-0J -E2
HD.RADIO-P.W.Board			<a href="#">E3</a>	23-09405Z12	CAP,CX 151-0J -E2
HD.RADIO-P.W.Board			<a href="#">IC1</a>	51-04432Z03	BD12KA5FP-E2 -NE5
HD.RADIO-P.W.Board			<a href="#">IC2</a>	51-17563Z02	SAF3560HV/V1100 -QT
HD.RADIO-P.W.Board			<a href="#">IC3</a>	83-22939Z10	12MY_FBI_HDBOTTOM_HD_Soft
HD.RADIO-P.W.Board			<a href="#">IC4</a>	51-18618Z01	H57V6462GTR-75I -ST
HD.RADIO-P.W.Board			<a href="#">L1</a>	24T95456W11	FBI,BLM18AG601SH1-CP
HD.RADIO-P.W.Board			<a href="#">L2</a>	24T95456W31	FBI,BLM18PG471SH1-CP
HD.RADIO-P.W.Board			<a href="#">L3</a>	24T95456W01	FBI,BLM18PG300SH1-CP
HD.RADIO-P.W.Board			<a href="#">L4</a>	24T95456W01	FBI,BLM18PG300SH1-CP
HD.RADIO-P.W.Board			<a href="#">L5</a>	24T95456W01	FBI,BLM18PG300SH1-CP
HD.RADIO-P.W.Board			<a href="#">L6</a>	24T95456W31	FBI,BLM18PG471SH1-CP
HD.RADIO-P.W.Board			<a href="#">R1</a>	06S15615Y13	RES,RK 33RJ 1/16 -CP
HD.RADIO-P.W.Board			<a href="#">R11</a>	06S15615Y23	RES,RK 82RJ 1/16 -CP
HD.RADIO-P.W.Board			<a href="#">R12</a>	06S15615Y23	RES,RK 82RJ 1/16 -CP
HD.RADIO-P.W.Board			<a href="#">R13</a>	06S15615Y73	RES,RK 103J 1/16 -CP
HD.RADIO-P.W.Board			<a href="#">R14</a>	06S45675W43	RES,RK JUMPER1/10-CP
HD.RADIO-P.W.Board			<a href="#">R15</a>	06S45675W43	RES,RK JUMPER1/10-CP
HD.RADIO-P.W.Board			<a href="#">R16</a>	06S15615Y23	RES,RK 82RJ 1/16 -CP
HD.RADIO-P.W.Board			<a href="#">R17</a>	06S15615Y25	RES,RK 101J 1/16 -CP
HD.RADIO-P.W.Board			<a href="#">R18</a>	06S15615Y25	RES,RK 101J 1/16 -CP
HD.RADIO-P.W.Board			<a href="#">R19</a>	06S15615Y69	RES,RK 682J 1/16 -CP
HD.RADIO-P.W.Board			<a href="#">R2</a>	06S15615Y13	RES,RK 33RJ 1/16 -CP
HD.RADIO-P.W.Board			<a href="#">R20</a>	06S15615Y69	RES,RK 682J 1/16 -CP
HD.RADIO-P.W.Board			<a href="#">R21</a>	06S15616Y23	RES,RK JUMPER1/16-CP
HD.RADIO-P.W.Board			<a href="#">R22</a>	06S15616Y23	RES,RK JUMPER1/16-CP
HD.RADIO-P.W.Board			<a href="#">R23</a>	06S65415Y37	RES,RK 103F 1/16 -CP
HD.RADIO-P.W.Board			<a href="#">R24</a>	06S65415Y37	RES,RK 103F 1/16 -CP
HD.RADIO-P.W.Board			<a href="#">R25</a>	06S15616Y23	RES,RK JUMPER1/16-CP
HD.RADIO-P.W.Board			<a href="#">R26</a>	06S15616Y23	RES,RK JUMPER1/16-CP
HD.RADIO-P.W.Board			<a href="#">R27</a>	06S65415Y31	RES,RK 332F 1/16 -CP
HD.RADIO-P.W.Board			<a href="#">R28</a>	06S65415Y31	RES,RK 332F 1/16 -CP
HD.RADIO-P.W.Board			<a href="#">R29</a>	06S15616Y23	RES,RK JUMPER1/16-CP
HD.RADIO-P.W.Board			<a href="#">R3</a>	06S65415Y37	RES,RK 103F 1/16 -CP
HD.RADIO-P.W.Board			<a href="#">R30</a>	06S15616Y23	RES,RK JUMPER1/16-CP

P.W.Board	MIS	MODEL	Ref.	Parts No.	Parts Name
HD.RADIO-P.W.Board			<a href="#">R31</a>	06S15616Y23	RES,RK JUMPER1/16-CP
HD.RADIO-P.W.Board			<a href="#">R32</a>	06S15616Y23	RES,RK JUMPER1/16-CP
HD.RADIO-P.W.Board			<a href="#">R33</a>	06S45675W43	RES,RK JUMPER1/10-CP
HD.RADIO-P.W.Board			<a href="#">R34</a>	06S15616Y23	RES,RK JUMPER1/16-CP
HD.RADIO-P.W.Board			<a href="#">R35</a>	06S65415Y09	RES,RK 47RF 1/16 -CP
HD.RADIO-P.W.Board			<a href="#">R36</a>	06S15616Y23	RES,RK JUMPER1/16-CP
HD.RADIO-P.W.Board			<a href="#">R37</a>	06S65415Y09	RES,RK 47RF 1/16 -CP
HD.RADIO-P.W.Board			<a href="#">R4</a>	06S65415Y37	RES,RK 103F 1/16 -CP
HD.RADIO-P.W.Board			<a href="#">R5</a>	06S15615Y13	RES,RK 33RJ 1/16 -CP
HD.RADIO-P.W.Board			<a href="#">R6</a>	06S15615Y13	RES,RK 33RJ 1/16 -CP
HD.RADIO-P.W.Board			<a href="#">R7</a>	06S15616Y23	RES,RK JUMPER1/16-CP
HD.RADIO-P.W.Board			<a href="#">R8</a>	06S15616Y23	RES,RK JUMPER1/16-CP
HD.RADIO-P.W.Board			<a href="#">R9</a>	06S15616Y23	RES,RK JUMPER1/16-CP
HD.RADIO-P.W.Board			<a href="#">RA1</a>	06S15771Y62	RES,ARYEXB28VR000-CP
HD.RADIO-P.W.Board			<a href="#">RA2</a>	06S15771Y62	RES,ARYEXB28VR000-CP
HD.RADIO-P.W.Board			<a href="#">RA3</a>	06S15771Y62	RES,ARYEXB28VR000-CP
HD.RADIO-P.W.Board			<a href="#">RA4</a>	06S15771Y62	RES,ARYEXB28VR000-CP
HD.RADIO-P.W.Board			<a href="#">RA5</a>	06S15771Y62	RES,ARYEXB28VR000-CP
HD.RADIO-P.W.Board			<a href="#">RA6</a>	06S15771Y62	RES,ARYEXB28VR000-CP
HD.RADIO-P.W.Board			<a href="#">RA7</a>	06S15771Y62	RES,ARYEXB28VR000-CP
HD.RADIO-P.W.Board			<a href="#">RA8</a>	06S15771Y62	RES,ARYEXB28VR000-CP
HD.RADIO-P.W.Board			<a href="#">RA9</a>	06S15771Y62	RES,ARYEXB28VR000-CP
HD.RADIO-P.W.Board			<a href="#">XL1</a>	91-15988Z14	XTL,NX3225GA 28.2-CP
Miscellaneous			<a href="#">M8000</a>	59-06122Z02	MOTOR,D02X-12TS2 03
SW(DP33U8BV)- P.W.Board			<a href="#">CB101</a>	09-09314Z01	FFC,IMSA9664S-11Y-EQ
SW(DP33U8BV)- P.W.Board			<a href="#">PT1</a>	48-04836Z01	PHT,TR PS1191RB22-CP
SW(DP33U8BV)- P.W.Board			<a href="#">PT2</a>	48-04836Z01	PHT,TR PS1191RB22-CP
SW(DP33U8BV)- P.W.Board			<a href="#">PT3</a>	48-04836Z01	PHT,TR PS1191RB22-CP
SW(DP33U8BV)- P.W.Board			<a href="#">SW1</a>	40T15494Y16	SW,DETCT SPVG1103-E6
FPC.PHOTO.VE- P.W.Board			C101	08S45677W42	CAP,CER.181J-CH1H-CP
FPC.PHOTO.VE- P.W.Board			C102	08S45677W42	CAP,CER.181J-CH1H-CP
FPC.PHOTO.VE- P.W.Board			C103	08S45677W42	CAP,CER.181J-CH1H-CP
FPC.PHOTO.VE- P.W.Board			LD101	48-01591Z01	LED,AN1105W-1-TR -CP
FPC.PHOTO.VE- P.W.Board			LD102	48-01591Z01	LED,AN1105W-1-TR -CP
FPC.PHOTO.VE- P.W.Board			LD103	48-01591Z01	LED,AN1105W-1-TR -CP
FPC.PHOTO.VE-			R101	06S45674W51	RES,RK 561J 1/10 -CP

P.W.Board	MIS	MODEL	Ref.	Parts No.	Parts Name
-----------	-----	-------	------	-----------	------------

P.W.Board					
FPC.PHOTO.VE- P.W.Board			R102	06S45674W51	RES,RK 561J 1/10 -CP
FPC.PHOTO.VE- P.W.Board			R103	06S45674W51	RES,RK 561J 1/10 -CP
Miscellaneous			<a href="#">HD1</a>	EP-12502Z06	EP21A96NP
Miscellaneous			<a href="#">M1</a>	66-19371Z75	ASSY,SPDL MTR 8BV
Miscellaneous			<a href="#">M2</a>	66-13908Z44	ASSY,LD-SLED MTR AOTA 8BV