

Exploded View (Cabinet) (1/2)

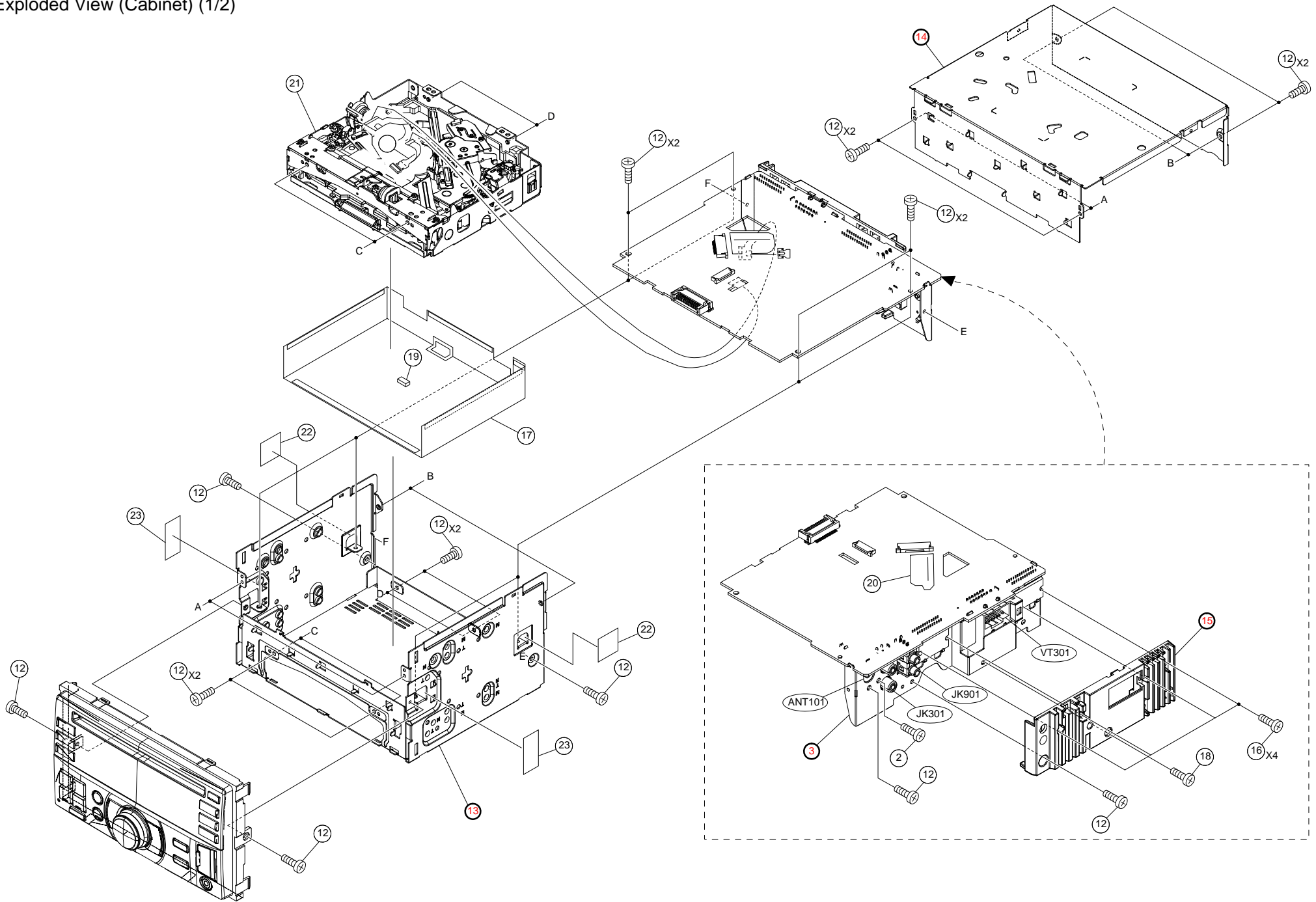

Exploded View (Cabinet) (2/2)

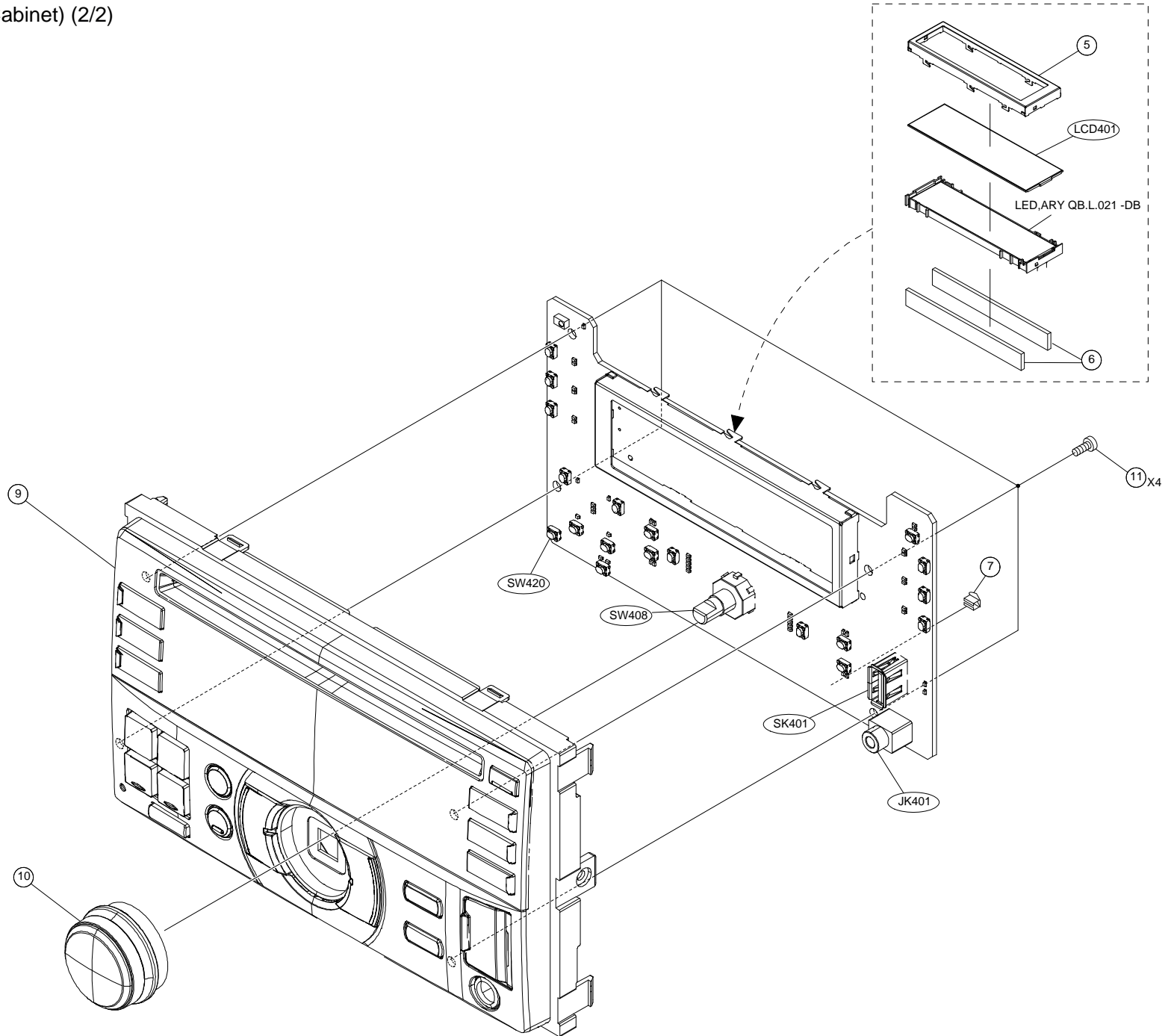

MODEL	Symbol No.	Parts No.	Description
	<a href="#">2</a>	03S60823Y13	SCR,P-T 2.6X8 ZN A
	<a href="#">3</a>	-----	BKT,REAR
	<a href="#">5</a>	15-21568Z01	COVER,LCD
	<a href="#">6</a>	75-20910Z02	RUBBER,62*7.4*1.5
	<a href="#">7</a>	29T45687Y02	OG-363040 -E5
	<a href="#">8</a>	84-09445Z01	FPC,11PIN MECH
	<a href="#">9</a>	EN-21575Z05	NOSE,PIECE ASSY
	<a href="#">10</a>	36-13957Z02	KNOB,ROTARY ASSY
	<a href="#">11</a>	03S60823Y36	SCR,P-T 2.6X8 ZN A
	<a href="#">12</a>	03S60822Y13	SCR,S-T 2.6X6 ZN A
	<a href="#">13</a>	-----	CHAS,BASE
	<a href="#">14</a>	-----	COVER,BOTTOM
	<a href="#">15</a>	-----	HEAT,SINK
	<a href="#">16</a>	03S60822Y22	SCR,S-T 2.6X14 ZN A
	<a href="#">17</a>	14-22520Z01	INS,COVER MECH
	<a href="#">18</a>	03S60825Y04	SCR,B-T 3X8 ZN A
	<a href="#">19</a>	75-06068Z64	CUS,RUB 14X4XT1.2
	<a href="#">20</a>	75-18694Z02	CUSHION,FFC
	<a href="#">21</a>	DP-12685Z01	DP33U8BV
	<a href="#">22</a>	54-14669Z01	LABEL,CHAS
	<a href="#">23</a>	54-14669Z02	LABEL,CHAS
	<a href="#">ANT101</a>	09T01876K01	ANT,RECEPTACLE
	<a href="#">JK301</a>	09-17989Z01	RCA,LPR1020-0600F-DB
	<a href="#">JK401</a>	09-18872Z01	JAC,1850383000322-DB
	<a href="#">JK901</a>	09-14149Z01	JAC,CK3-3.5-14D -DB
	<a href="#">LCD401</a>	65-21757Z01	LCD,TG6758M0TTN-FZ
	<a href="#">SK401</a>	09-19382Z01	SKT,CM-V105 -DB
	<a href="#">SW408</a>	40-10735Z02	ENC,EC12D1524405 -DB
	<a href="#">SW420</a>	40T65353Y01	SW,TACT SKRSPACE010E2
	<a href="#">VT301</a>	24-02502Z02	ASSY,W277A001 -DB

# Exploded View (CD Deck Mechanism)

(DP33U8BV)

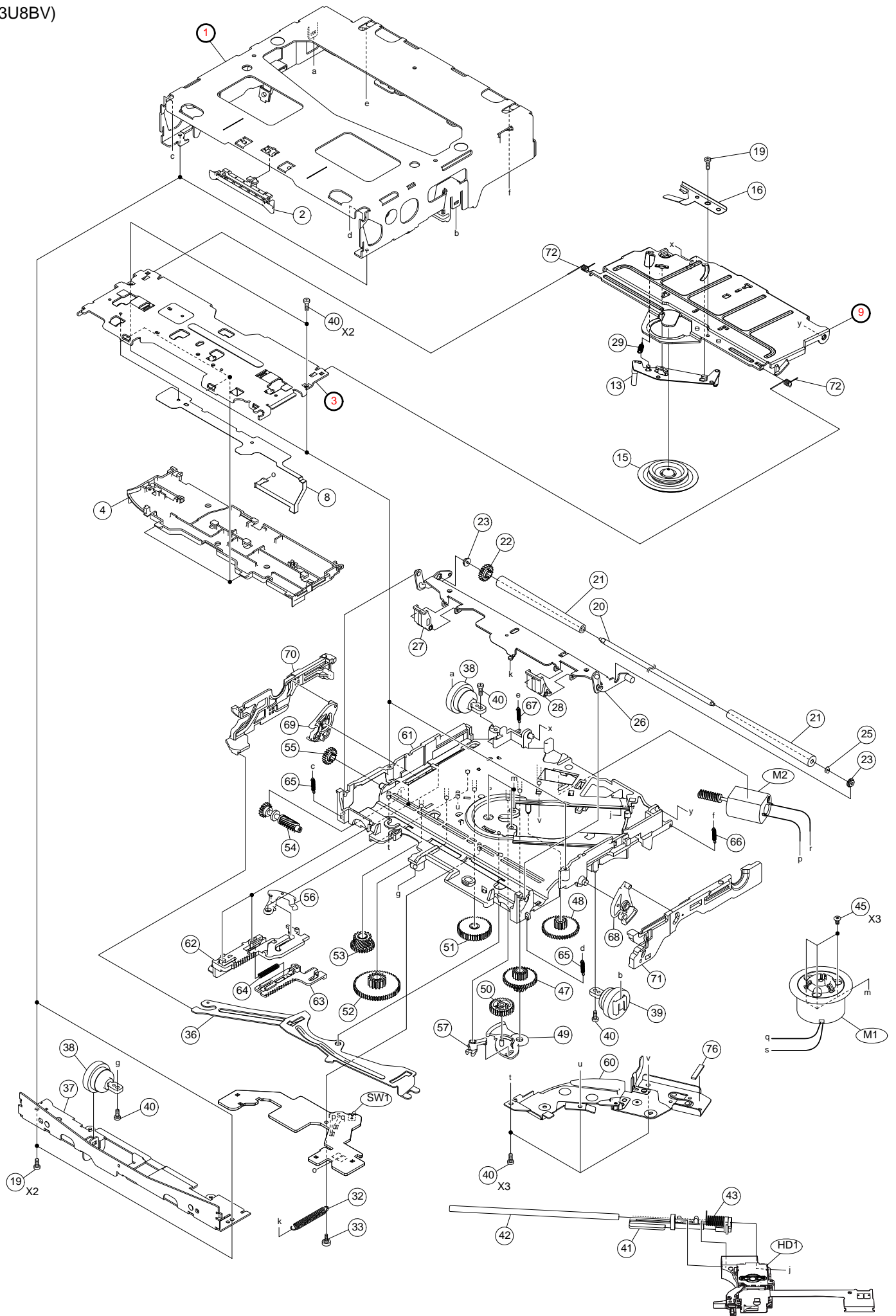

MODEL	Symbol No.	Parts No.	Description
	<a href="#">1</a>	-----	CHAS,BASE DP-U
	<a href="#">2</a>	15-08614Z01	GUIDE,TOP 2 DP-U
	<a href="#">3</a>	-----	CHAS,TOP 8LS
	<a href="#">4</a>	15-10062Z05	GUIDE,TOP 8LS
	<a href="#">8</a>	84-14334Z01	FPC,PHOTO VE
	<a href="#">9</a>	-----	ARM,CLAPM 8LS
	<a href="#">13</a>	45-10065Z04	LEVER,ACTUATOR 8LS
	<a href="#">15</a>	43-17679Z02	TABLE,CLAMPER 2
	<a href="#">16</a>	41-14419Z01	SPG,CLAMPER VE-2
	<a href="#">19</a>	03S60822Y43	SCR,S-T 2X3 ZN A
	<a href="#">20</a>	47-04894Z03	SHAFT,ROLLER DP-U
	<a href="#">21</a>	49-07008Z02	ROLLER,DP-U
	<a href="#">22</a>	44-08626Z01	GEAR,ROLLER
	<a href="#">23</a>	43-08617Z01	BUSH,ROLLER DP-U
	<a href="#">25</a>	04S40075G88	WAS,LOC 1.7X4.5X0.25
	<a href="#">26</a>	45-10061Z04	ARM,DISC GUIDE 8LS
	<a href="#">27</a>	45-08642Z01	ARM,FENCE L
	<a href="#">28</a>	45-08643Z01	ARM,FENCE R
	<a href="#">29</a>	41-05867Z14	SPRING,ACTUATOR-2
	<a href="#">32</a>	41-05867Z11	SPRING,ROLLER AOTA 2
	<a href="#">33</a>	03-10564Z02	SCR,SPG.ROLLER AOTA2
	<a href="#">36</a>	45-12698Z01	LEVER,LINK DRIVE 2
	<a href="#">37</a>	07-04867Z02	BKT,DAMPER
	<a href="#">38</a>	75-13914Z01	DAMPER,DP-U VE Z01
	<a href="#">39</a>	75-13914Z02	DAMPER,DP-U VE Z02
	<a href="#">40</a>	03S70693Y06	SCR,P-T 2X6 ZB A
	<a href="#">41</a>	44-08628Z01	RACK,SLED
	<a href="#">42</a>	47-04895Z01	SHAFT,PICK DP-U
	<a href="#">43</a>	41-05866Z02	SPRING,SLED
	<a href="#">45</a>	03S60820Y72	SCR,MCH 1.7X3 ZN A
	<a href="#">47</a>	44-08618Z04	GEAR,A
	<a href="#">48</a>	44-08619Z01	GEAR,B
	<a href="#">49</a>	45-08631Z01	LEVER,TIMING GEAR
	<a href="#">50</a>	44-08620Z01	GEAR,C
	<a href="#">51</a>	44-08621Z01	GEAR,D
	<a href="#">52</a>	44-08622Z04	GEAR,E
	<a href="#">53</a>	44-08623Z04	GEAR,F
	<a href="#">54</a>	44-08624Z03	GEAR,G
	<a href="#">55</a>	44-09654Z01	GEAR,H-2
	<a href="#">56</a>	45-08632Z01	LEVER,LOCK DP-U
	<a href="#">57</a>	45-08630Z01	LEVER,TIMING PICK
	<a href="#">60</a>	07-05523Z02	ASSY,RIV COVER MTR
	<a href="#">61</a>	27-19539Z01	CHAS,PICK 8LS 5
	<a href="#">62</a>	45-15742Z01	SLIDER,LOAD 2
	<a href="#">63</a>	45-15743Z01	SLIDER,TIMING LOAD 2
	<a href="#">64</a>	41-05874Z02	SPRING,TIMING
	<a href="#">65</a>	41-05867Z02	SPRING,DRIVE F

MODEL	Symbol No.	Parts No.	Description
-------	------------	-----------	-------------

	<a href="#">66</a>	41-05867Z13	SPRING,DRIVE RR-2
	<a href="#">67</a>	41-05867Z04	SPRING,DRIVE RL
	<a href="#">68</a>	45-08639Z06	ARM,LOCK R DP-U
	<a href="#">69</a>	45-15741Z01	ARM,LOCK L 2
	<a href="#">70</a>	45-10066Z04	SLIDER,LOCK L 8LS
	<a href="#">71</a>	45-10067Z04	SLIDER,LOCK R 8LS
	<a href="#">72</a>	41-05871Z02	SPRING,ARM CLAMP
	<a href="#">76</a>	14-06145Z92	INS,CVR 12X3XT1
	<a href="#">HD1</a>	EP-12502Z06	EP21A96NP
	<a href="#">M1</a>	66-19371Z75	ASSY,SPDL MTR 8BV
	<a href="#">M2</a>	66-13908Z44	ASSY,LD-SLED MTR AOTA 8BV
	<a href="#">SW1</a>	40T15494Y16	SW,DETCT SPVG1103-E6

# Packing Method View

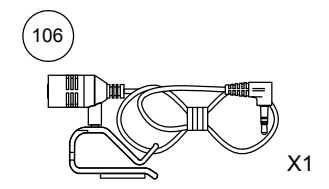
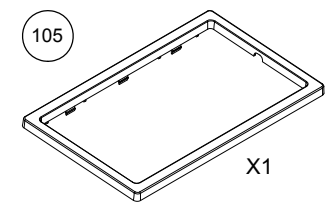
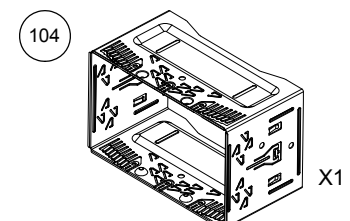
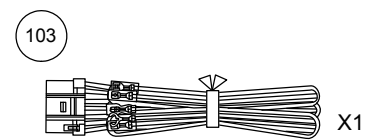
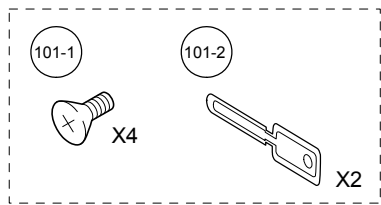
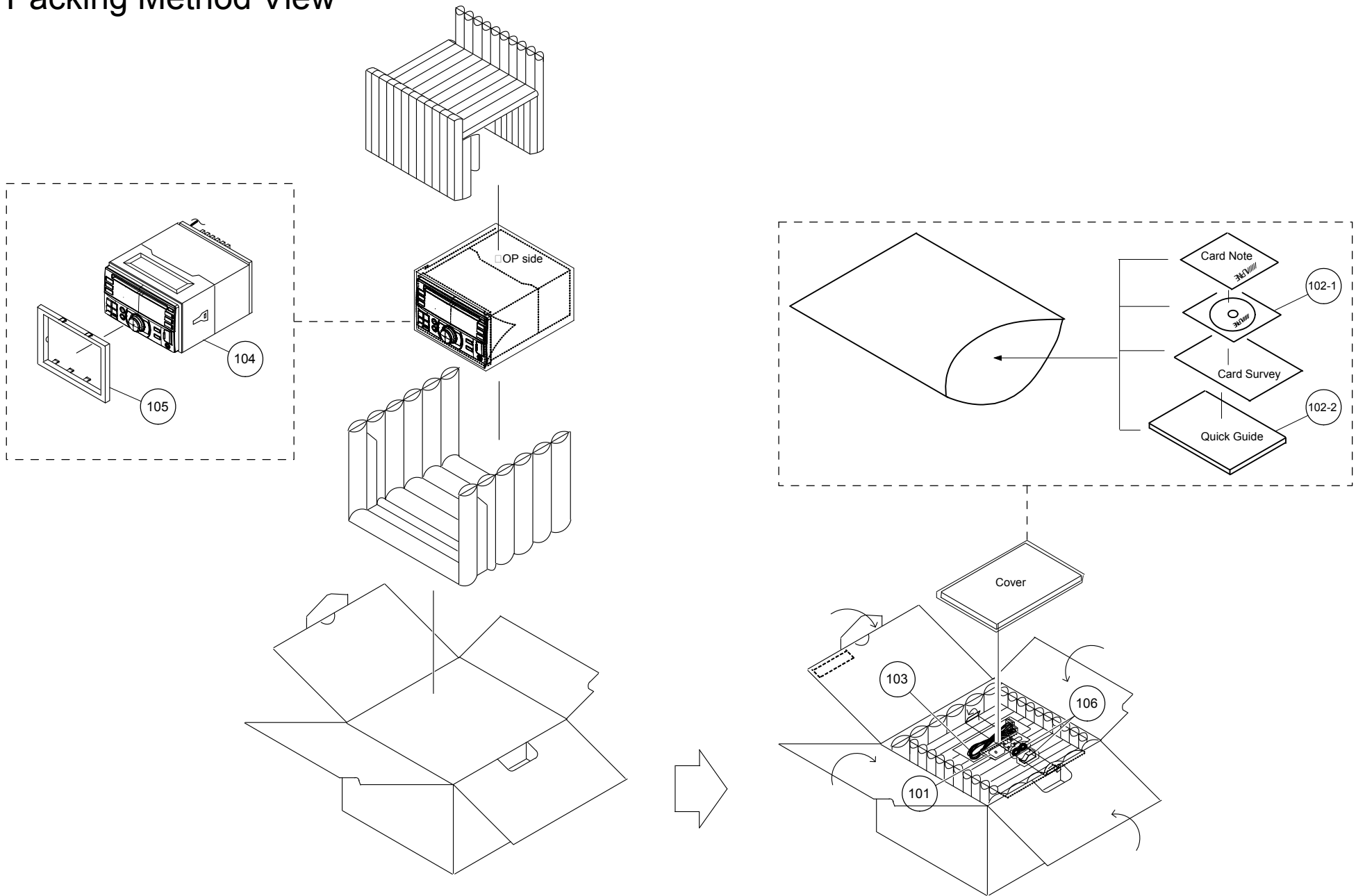

MODEL	Symbol No.	Parts No.	Description
	<a href="#">101-1</a>	03S60820Y16	SCR,MCH 5X8 ZN A
	<a href="#">101-2</a>	07-01964Z01	BKT,RELEASE
	<a href="#">102-1</a>	68-10334Z52	O/M-CDROM 2DIN AOAM
	<a href="#">102-2</a>	68-21627Z63	C/N-QRG AOAM DDA
	<a href="#">103</a>	09-17244Z01	ASSY,ANIC-0050-01A
	<a href="#">104</a>	15-14189Z01	CASE,INNER
	<a href="#">105</a>	33-14124Z02	FACE,PLATE
	<a href="#">106</a>	50-14386Z03	ASSY,LYS-M9750-FUL



P.W.Board	MIS	MODEL	Ref.	Parts No.	Parts Name
MAIN-P.W.Board			<a href="#">ANT101</a>	09T01876K01	ANT,RECEPTACLE
MAIN-P.W.Board			<a href="#">C100</a>	08S65669Y03	CAP,CER 224KX7R1H-CP
MAIN-P.W.Board			<a href="#">C186</a>	08S82122F17	CAP,CER.15RJ-CH1H-CP
MAIN-P.W.Board			<a href="#">C187</a>	08S45677W60	CAP,CER 102J-CH1H-CP
MAIN-P.W.Board			<a href="#">C188</a>	08S45231Y19	CAP,CER 33RJ-CH1H-CP
MAIN-P.W.Board			<a href="#">C189</a>	08-17773Z01	CAP,CER 2R2B-CH1H-CP
MAIN-P.W.Board			<a href="#">C190</a>	08S45231Y14	CAP,CER 12RJ-CH1H-CP
MAIN-P.W.Board			<a href="#">C191</a>	08S45677W60	CAP,CER 102J-CH1H-CP
MAIN-P.W.Board			<a href="#">C192</a>	08S45676W93	CAP,CER 224K-B1A -CP
MAIN-P.W.Board			<a href="#">C193</a>	08S45677W60	CAP,CER 102J-CH1H-CP
MAIN-P.W.Board			<a href="#">C194</a>	08S65674Y08	CAP,CER 105KX5R1E-CP
MAIN-P.W.Board			<a href="#">C195</a>	08S45676W93	CAP,CER 224K-B1A -CP
MAIN-P.W.Board			<a href="#">C196</a>	08S65668Y04	CAP,CER 104KX5R1A-CP
MAIN-P.W.Board			<a href="#">C197</a>	08S45231Y13	CAP,CER 10RD-CH1H-CP
MAIN-P.W.Board			<a href="#">C198</a>	08S45232Y11	CAP,CER 103K-B1C -CP
MAIN-P.W.Board			<a href="#">C199</a>	08S45232Y11	CAP,CER 103K-B1C -CP
MAIN-P.W.Board			<a href="#">C200</a>	08S65674Y08	CAP,CER 105KX5R1E-CP
MAIN-P.W.Board			<a href="#">C201</a>	08S45232Y11	CAP,CER 103K-B1C -CP
MAIN-P.W.Board			<a href="#">C202</a>	08S65668Y04	CAP,CER 104KX5R1A-CP
MAIN-P.W.Board			<a href="#">C203</a>	08S45232Y11	CAP,CER 103K-B1C -CP
MAIN-P.W.Board			<a href="#">C204</a>	08S65668Y04	CAP,CER 104KX5R1A-CP
MAIN-P.W.Board			<a href="#">C205</a>	08S65674Y08	CAP,CER 105KX5R1E-CP
MAIN-P.W.Board			<a href="#">C206</a>	08S65668Y04	CAP,CER 104KX5R1A-CP
MAIN-P.W.Board			<a href="#">C208</a>	08S65667Y01	CAP,CER 224KX5R1C-CP
MAIN-P.W.Board			<a href="#">C302</a>	08S65669Y03	CAP,CER 224KX7R1H-CP
MAIN-P.W.Board			<a href="#">C303</a>	08S65669Y03	CAP,CER 224KX7R1H-CP
MAIN-P.W.Board			<a href="#">C304</a>	08S65669Y03	CAP,CER 224KX7R1H-CP
MAIN-P.W.Board			<a href="#">C305</a>	08S65669Y03	CAP,CER 224KX7R1H-CP
MAIN-P.W.Board			<a href="#">C306</a>	08S35350Y04	CAP,CER 105K-B1C -CP
MAIN-P.W.Board			<a href="#">C309</a>	08S35350Y04	CAP,CER 105K-B1C -CP
MAIN-P.W.Board			<a href="#">C310</a>	08S45676W83	CAP,CER 473K-B1C -CP
MAIN-P.W.Board			<a href="#">C311</a>	08S35350Y04	CAP,CER 105K-B1C -CP
MAIN-P.W.Board			<a href="#">C312</a>	08S65669Y03	CAP,CER 224KX7R1H-CP
MAIN-P.W.Board			<a href="#">C314</a>	08S65669Y03	CAP,CER 224KX7R1H-CP
MAIN-P.W.Board			<a href="#">C315</a>	08S65676Y07	CAP,CER 225K-X7R1ECP
MAIN-P.W.Board			<a href="#">C316</a>	08S65676Y07	CAP,CER 225K-X7R1ECP
MAIN-P.W.Board			<a href="#">C317</a>	08S45677W54	CAP,CER 561J-CH1H-CP
MAIN-P.W.Board			<a href="#">C318</a>	08S65676Y07	CAP,CER 225K-X7R1ECP
MAIN-P.W.Board			<a href="#">C319</a>	08S45677W46	CAP,CER 271J-CH1H-CP
MAIN-P.W.Board			<a href="#">C320</a>	08S65676Y07	CAP,CER 225K-X7R1ECP
MAIN-P.W.Board			<a href="#">C321</a>	08S45677W46	CAP,CER 271J-CH1H-CP
MAIN-P.W.Board			<a href="#">C323</a>	08S65676Y07	CAP,CER 225K-X7R1ECP
MAIN-P.W.Board			<a href="#">C324</a>	08S45677W54	CAP,CER 561J-CH1H-CP
MAIN-P.W.Board			<a href="#">C325</a>	08S65676Y08	CAP,CER 106K-X7R1ACP
MAIN-P.W.Board			<a href="#">C326</a>	08S65676Y07	CAP,CER 225K-X7R1ECP
MAIN-P.W.Board			<a href="#">C327</a>	08S65669Y03	CAP,CER 224KX7R1H-CP
MAIN-P.W.Board			<a href="#">C329</a>	08S65669Y03	CAP,CER 224KX7R1H-CP

P.W.Board	MIS	MODEL	Ref.	Parts No.	Parts Name
MAIN-P.W.Board			<a href="#">C355</a>	08S65669Y03	CAP,CER 224KX7R1H-CP
MAIN-P.W.Board			<a href="#">C500</a>	08S45232Y11	CAP,CER 103K-B1C -CP
MAIN-P.W.Board			<a href="#">C502</a>	08S65667Y01	CAP,CER 224KX5R1C-CP
MAIN-P.W.Board			<a href="#">C503</a>	08S65667Y01	CAP,CER 224KX5R1C-CP
MAIN-P.W.Board			<a href="#">C504</a>	08S65667Y01	CAP,CER 224KX5R1C-CP
MAIN-P.W.Board			<a href="#">C505</a>	08S65667Y01	CAP,CER 224KX5R1C-CP
MAIN-P.W.Board			<a href="#">C506</a>	08S65667Y01	CAP,CER 224KX5R1C-CP
MAIN-P.W.Board			<a href="#">C507</a>	08S65667Y01	CAP,CER 224KX5R1C-CP
MAIN-P.W.Board			<a href="#">C508</a>	08S65667Y01	CAP,CER 224KX5R1C-CP
MAIN-P.W.Board			<a href="#">C509</a>	08S45231Y17	CAP,CER 22RJ-CH1H-CP
MAIN-P.W.Board			<a href="#">C510</a>	08S45231Y17	CAP,CER 22RJ-CH1H-CP
MAIN-P.W.Board			<a href="#">C511</a>	08S45677W14	CAP,CER.12RJ-CH1H-CP
MAIN-P.W.Board			<a href="#">C512</a>	08S45677W16	CAP,CER.15RJ-CH1H-CP
MAIN-P.W.Board			<a href="#">C514</a>	08S45677W60	CAP,CER 102J-CH1H-CP
MAIN-P.W.Board			<a href="#">C516</a>	08S45232Y11	CAP,CER 103K-B1C -CP
MAIN-P.W.Board			<a href="#">C601</a>	08S35349Y16	CAP,CER 105K-B1A -CP
MAIN-P.W.Board			<a href="#">C602</a>	08S35349Y16	CAP,CER 105K-B1A -CP
MAIN-P.W.Board			<a href="#">C702</a>	08S45232Y17	CAP,CER 104K-B0J -CP
MAIN-P.W.Board			<a href="#">C703</a>	08S45232Y05	CAP,CER 102K-B1H -CP
MAIN-P.W.Board			<a href="#">C704</a>	08S65668Y05	CAP,CER 224KX5R1A-CP
MAIN-P.W.Board			<a href="#">C705</a>	08S45232Y17	CAP,CER 104K-B0J -CP
MAIN-P.W.Board			<a href="#">C707</a>	08S35349Y17	CAP,CER 225K-B0J -CP
MAIN-P.W.Board			<a href="#">C708</a>	08S45231Y17	CAP,CER 22RJ-CH1H-CP
MAIN-P.W.Board			<a href="#">C709</a>	08S45231Y16	CAP,CER 18RJ-CH1H-CP
MAIN-P.W.Board			<a href="#">C710</a>	08S45232Y17	CAP,CER 104K-B0J -CP
MAIN-P.W.Board			<a href="#">C711</a>	08S45232Y17	CAP,CER 104K-B0J -CP
MAIN-P.W.Board			<a href="#">C712</a>	08S45231Y18	CAP,CER 27RJ-CH1H-CP
MAIN-P.W.Board			<a href="#">C713</a>	08S45231Y18	CAP,CER 27RJ-CH1H-CP
MAIN-P.W.Board			<a href="#">C716</a>	08S45231Y25	CAP,CER 101J-CH1H-CP
MAIN-P.W.Board			<a href="#">C717</a>	08S45676W80	CAP,CER 223K-B1E -CP
MAIN-P.W.Board			<a href="#">C718</a>	08S65667Y01	CAP,CER 224KX5R1C-CP
MAIN-P.W.Board			<a href="#">C719</a>	08S45232Y17	CAP,CER 104K-B0J -CP
MAIN-P.W.Board			<a href="#">C720</a>	08S45231Y25	CAP,CER 101J-CH1H-CP
MAIN-P.W.Board			<a href="#">C721</a>	08S45231Y25	CAP,CER 101J-CH1H-CP
MAIN-P.W.Board			<a href="#">C722</a>	08S45231Y25	CAP,CER 101J-CH1H-CP
MAIN-P.W.Board			<a href="#">C723</a>	08S35349Y17	CAP,CER 225K-B0J -CP
MAIN-P.W.Board			<a href="#">C724</a>	08S45231Y15	CAP,CER 15RJ-CH1H-CP
MAIN-P.W.Board			<a href="#">C725</a>	08S45232Y17	CAP,CER 104K-B0J -CP
MAIN-P.W.Board			<a href="#">C726</a>	08S45232Y08	CAP,CER 332K-B1H -CP
MAIN-P.W.Board			<a href="#">C727</a>	08S45676W69	CAP,CER.472K-B1H -CP
MAIN-P.W.Board			<a href="#">C728</a>	08S45232Y12	CAP,CER 153K-B1C -CP
MAIN-P.W.Board			<a href="#">C729</a>	08S45232Y17	CAP,CER 104K-B0J -CP
MAIN-P.W.Board			<a href="#">C731</a>	08S45232Y17	CAP,CER 104K-B0J -CP
MAIN-P.W.Board			<a href="#">C732</a>	08S45232Y17	CAP,CER 104K-B0J -CP
MAIN-P.W.Board			<a href="#">C733</a>	08S45232Y17	CAP,CER 104K-B0J -CP
MAIN-P.W.Board			<a href="#">C734</a>	08S45232Y14	CAP,CER 333K-B1C -CP
MAIN-P.W.Board			<a href="#">C736</a>	08S45232Y14	CAP,CER 333K-B1C -CP

P.W.Board	MIS	MODEL	Ref.	Parts No.	Parts Name
MAIN-P.W.Board			<a href="#">C737</a>	08S45232Y08	CAP,CER 332K-B1H -CP
MAIN-P.W.Board			<a href="#">C738</a>	08S45676W73	CAP,CER.103K-B1H -CP
MAIN-P.W.Board			<a href="#">C739</a>	08S45232Y14	CAP,CER 333K-B1C -CP
MAIN-P.W.Board			<a href="#">C740</a>	08S45232Y11	CAP,CER 103K-B1C -CP
MAIN-P.W.Board			<a href="#">C741</a>	08S45232Y17	CAP,CER 104K-B0J -CP
MAIN-P.W.Board			<a href="#">C742</a>	08S45231Y21	CAP,CER 47RJ-CH1H-CP
MAIN-P.W.Board			<a href="#">C743</a>	08S45232Y12	CAP,CER 153K-B1C -CP
MAIN-P.W.Board			<a href="#">C744</a>	08S45232Y07	CAP,CER 222K-B1H -CP
MAIN-P.W.Board			<a href="#">C745</a>	08S45232Y17	CAP,CER 104K-B0J -CP
MAIN-P.W.Board			<a href="#">C746</a>	08S45232Y17	CAP,CER 104K-B0J -CP
MAIN-P.W.Board			<a href="#">C749</a>	08S45232Y06	CAP,CER 152K-B1H -CP
MAIN-P.W.Board			<a href="#">C750</a>	08S45232Y06	CAP,CER 152K-B1H -CP
MAIN-P.W.Board			<a href="#">C751</a>	08S45232Y14	CAP,CER 333K-B1C -CP
MAIN-P.W.Board			<a href="#">C752</a>	08S45232Y05	CAP,CER 102K-B1H -CP
MAIN-P.W.Board			<a href="#">C753</a>	08S35374W12	CAP,CER 106K-B0J -CP
MAIN-P.W.Board			<a href="#">C754</a>	08S45232Y14	CAP,CER 333K-B1C -CP
MAIN-P.W.Board			<a href="#">C755</a>	08S45232Y08	CAP,CER 332K-B1H -CP
MAIN-P.W.Board			<a href="#">C756</a>	08S35374W12	CAP,CER 106K-B0J -CP
MAIN-P.W.Board			<a href="#">C757</a>	08S45231Y14	CAP,CER 12RJ-CH1H-CP
MAIN-P.W.Board			<a href="#">C758</a>	08S45232Y17	CAP,CER 104K-B0J -CP
MAIN-P.W.Board			<a href="#">C759</a>	08S45232Y17	CAP,CER 104K-B0J -CP
MAIN-P.W.Board			<a href="#">C762</a>	08S45232Y06	CAP,CER 152K-B1H -CP
MAIN-P.W.Board			<a href="#">C763</a>	08S35374W12	CAP,CER 106K-B0J -CP
MAIN-P.W.Board			<a href="#">C764</a>	08S45231Y38	CAP,CER 102J-CH1E-CP
MAIN-P.W.Board			<a href="#">C765</a>	08S65669Y03	CAP,CER 224KX7R1H-CP
MAIN-P.W.Board			<a href="#">C766</a>	08S45231Y28	CAP,CER 181J-CH1H-CP
MAIN-P.W.Board			<a href="#">C767</a>	08S45676W70	CAP,CER 562K-B1H -CP
MAIN-P.W.Board			<a href="#">C768</a>	08S45676W75	CAP,CER.153K-B1H -CP
MAIN-P.W.Board			<a href="#">C769</a>	08S45676W66	CAP,CER.272K-B1H -CP
MAIN-P.W.Board			<a href="#">C770</a>	08S65669Y03	CAP,CER 224KX7R1H-CP
MAIN-P.W.Board			<a href="#">C771</a>	08S65669Y03	CAP,CER 224KX7R1H-CP
MAIN-P.W.Board			<a href="#">C772</a>	08S45676W93	CAP,CER 224K-B1A -CP
MAIN-P.W.Board			<a href="#">C774</a>	08S35349Y15	CAP,CER 474K-B1A -CP
MAIN-P.W.Board			<a href="#">C775</a>	08S45232Y05	CAP,CER 102K-B1H -CP
MAIN-P.W.Board			<a href="#">C776</a>	08S35349Y15	CAP,CER 474K-B1A -CP
MAIN-P.W.Board			<a href="#">C777</a>	08S45232Y08	CAP,CER 332K-B1H -CP
MAIN-P.W.Board			<a href="#">C778</a>	08S45232Y13	CAP,CER 223K-B1C -CP
MAIN-P.W.Board			<a href="#">C780</a>	08S45676W85	CAP,CER 104K-B1C -CP
MAIN-P.W.Board			<a href="#">C781</a>	08S65669Y03	CAP,CER 224KX7R1H-CP
MAIN-P.W.Board			<a href="#">C782</a>	08S65669Y03	CAP,CER 224KX7R1H-CP
MAIN-P.W.Board			<a href="#">C784</a>	08S65667Y01	CAP,CER 224KX5R1C-CP
MAIN-P.W.Board			<a href="#">C785</a>	08S45676W93	CAP,CER 224K-B1A -CP
MAIN-P.W.Board			<a href="#">C786</a>	08S45232Y11	CAP,CER 103K-B1C -CP
MAIN-P.W.Board			<a href="#">C787</a>	08S65669Y03	CAP,CER 224KX7R1H-CP
MAIN-P.W.Board			<a href="#">C800</a>	08S65669Y03	CAP,CER 224KX7R1H-CP
MAIN-P.W.Board			<a href="#">C801</a>	08S65128F88	CAP,CER 104K-B1H -CP
MAIN-P.W.Board			<a href="#">C802</a>	08S45676W85	CAP,CER 104K-B1C -CP

P.W.Board	MIS	MODEL	Ref.	Parts No.	Parts Name
MAIN-P.W.Board			<a href="#">C803</a>	08S65669Y03	CAP,CER 224KX7R1H-CP
MAIN-P.W.Board			<a href="#">C804</a>	08S65669Y03	CAP,CER 224KX7R1H-CP
MAIN-P.W.Board			<a href="#">C805</a>	08S65669Y03	CAP,CER 224KX7R1H-CP
MAIN-P.W.Board			<a href="#">C806</a>	08S65669Y03	CAP,CER 224KX7R1H-CP
MAIN-P.W.Board			<a href="#">C807</a>	08S65669Y03	CAP,CER 224KX7R1H-CP
MAIN-P.W.Board			<a href="#">C808</a>	08S65669Y03	CAP,CER 224KX7R1H-CP
MAIN-P.W.Board			<a href="#">C809</a>	08S65669Y03	CAP,CER 224KX7R1H-CP
MAIN-P.W.Board			<a href="#">C810</a>	08S65669Y03	CAP,CER 224KX7R1H-CP
MAIN-P.W.Board			<a href="#">C811</a>	08S65669Y03	CAP,CER 224KX7R1H-CP
MAIN-P.W.Board			<a href="#">C812</a>	08S65669Y03	CAP,CER 224KX7R1H-CP
MAIN-P.W.Board			<a href="#">C813</a>	08S65669Y03	CAP,CER 224KX7R1H-CP
MAIN-P.W.Board			<a href="#">C814</a>	08S65669Y03	CAP,CER 224KX7R1H-CP
MAIN-P.W.Board			<a href="#">C815</a>	08S65669Y03	CAP,CER 224KX7R1H-CP
MAIN-P.W.Board			<a href="#">C816</a>	08S65669Y03	CAP,CER 224KX7R1H-CP
MAIN-P.W.Board			<a href="#">C817</a>	08S65128F90	CAP,CER 473K-B1H -CP
MAIN-P.W.Board			<a href="#">C818</a>	08S65669Y03	CAP,CER 224KX7R1H-CP
MAIN-P.W.Board			<a href="#">C819</a>	08S65669Y03	CAP,CER 224KX7R1H-CP
MAIN-P.W.Board			<a href="#">C820</a>	08S65669Y03	CAP,CER 224KX7R1H-CP
MAIN-P.W.Board			<a href="#">C821</a>	08S65669Y03	CAP,CER 224KX7R1H-CP
MAIN-P.W.Board			<a href="#">C822</a>	08S65667Y05	CAP,CER 105KX5R1A-CP
MAIN-P.W.Board			<a href="#">C823</a>	08S65669Y03	CAP,CER 224KX7R1H-CP
MAIN-P.W.Board			<a href="#">C824</a>	08S65669Y03	CAP,CER 224KX7R1H-CP
MAIN-P.W.Board			<a href="#">C825</a>	08S65669Y03	CAP,CER 224KX7R1H-CP
MAIN-P.W.Board			<a href="#">C826</a>	08S65669Y03	CAP,CER 224KX7R1H-CP
MAIN-P.W.Board			<a href="#">C827</a>	08S65669Y03	CAP,CER 224KX7R1H-CP
MAIN-P.W.Board			<a href="#">C828</a>	08S45232Y11	CAP,CER 103K-B1C -CP
MAIN-P.W.Board			<a href="#">C901</a>	08S35374W01	CAP,CER 104K-B1E-CP
MAIN-P.W.Board			<a href="#">C902</a>	08S65128F78	CAP,CER.223K-B1H -CP
MAIN-P.W.Board			<a href="#">C903</a>	08S45676W65	CAP,CER.222K-B1H -CP
MAIN-P.W.Board			<a href="#">C904</a>	08S45677W36	CAP,CER.101J-CH1H-CP
MAIN-P.W.Board			<a href="#">CB501</a>	09T35116Y20	BTB,IMSA9850B-20Y-EK
MAIN-P.W.Board			<a href="#">CB701</a>	09T55174Y11	FFC,IMSA9616S-11Y-ED
MAIN-P.W.Board			<a href="#">CB702</a>	09-09312Z02	FFC,IMSA9663S-15Y-EQ
MAIN-P.W.Board			<a href="#">CH601</a>	09-21046Z01	BTB,24R-JMCS-G-B -E5
MAIN-P.W.Board			<a href="#">D101</a>	48-12230Z01	DIO,KDS226-RTK -CP
MAIN-P.W.Board			<a href="#">D302</a>	48-07015Z01	DIO,KDS160-RTK -CP
MAIN-P.W.Board			<a href="#">D304</a>	48T75446Y01	DIO,RR264M-400 -CP
MAIN-P.W.Board			<a href="#">D801</a>	48T75527Y01	DIO,1SR154-400 -E1
MAIN-P.W.Board			<a href="#">D802</a>	48-05164Z01	DIO,1SS352-TPH3 -CP
MAIN-P.W.Board			<a href="#">D803</a>	48T75527Y01	DIO,1SR154-400 -E1
MAIN-P.W.Board			<a href="#">D804</a>	48T75527Y01	DIO,1SR154-400 -E1
MAIN-P.W.Board			<a href="#">D901</a>	48-07016Z02	DIO,KDS184-RTK -CP
MAIN-P.W.Board			<a href="#">E101</a>	23S65134W34	CAP,ELY 47R-1C(6)-E6
MAIN-P.W.Board			<a href="#">E103</a>	23S65134W81	CAP,ELY 22R-1C(4)-E2
MAIN-P.W.Board			<a href="#">E301</a>	23S65134W53	CAP,ELY 4R7-1V(4)-E2
MAIN-P.W.Board			<a href="#">E302</a>	23S65134W53	CAP,ELY 4R7-1V(4)-E2
MAIN-P.W.Board			<a href="#">E303</a>	23S65134W53	CAP,ELY 4R7-1V(4)-E2

P.W.Board	MIS	MODEL	Ref.	Parts No.	Parts Name
MAIN-P.W.Board			<a href="#">E304</a>	23S65134W53	CAP,ELY 4R7-1V(4)-E2
MAIN-P.W.Board			<a href="#">E305</a>	23S75244Y25	CAP,ELY 22R-1E -E3
MAIN-P.W.Board			<a href="#">E306</a>	23S65134W53	CAP,ELY 4R7-1V(4)-E2
MAIN-P.W.Board			<a href="#">E307</a>	23S65134W34	CAP,ELY 47R-1C(6)-E6
MAIN-P.W.Board			<a href="#">E308</a>	23T75234Y20	CAP,MAR 22R-1E-F55E6
MAIN-P.W.Board			<a href="#">E309</a>	23T75234Y20	CAP,MAR 22R-1E-F55E6
MAIN-P.W.Board			<a href="#">E310</a>	23S65134W41	CAP,ELY 4R7-1E(3)-E2
MAIN-P.W.Board			<a href="#">E311</a>	23S65134W41	CAP,ELY 4R7-1E(3)-E2
MAIN-P.W.Board			<a href="#">E312</a>	23T75346W03	CAP,X-PRO 332-1C +
MAIN-P.W.Board			<a href="#">E313</a>	23S65134W52	CAP,ELY 3R3-1V(3)-E2
MAIN-P.W.Board			<a href="#">E314</a>	23S65134W52	CAP,ELY 3R3-1V(3)-E2
MAIN-P.W.Board			<a href="#">E315</a>	23T75234Y20	CAP,MAR 22R-1E-F55E6
MAIN-P.W.Board			<a href="#">E501</a>	23S75244Y20	CAP,ELY 221-1C -E6
MAIN-P.W.Board			<a href="#">E601</a>	23S65134W24	CAP,ELY 221-1A(8)-E6
MAIN-P.W.Board			<a href="#">E700</a>	23S75244Y18	CAP,ELY 47R-1C -E3
MAIN-P.W.Board			<a href="#">E702</a>	23S75244Y18	CAP,ELY 47R-1C -E3
MAIN-P.W.Board			<a href="#">E704</a>	23S75244Y19	CAP,ELY 101-1C -E6
MAIN-P.W.Board			<a href="#">E705</a>	23T65679Y11	CAP,CD 47R-0J -E2
MAIN-P.W.Board			<a href="#">E706</a>	23S65134W24	CAP,ELY 221-1A(8)-E6
MAIN-P.W.Board			<a href="#">E708</a>	23S75244Y19	CAP,ELY 101-1C -E6
MAIN-P.W.Board			<a href="#">E709</a>	23S75244Y19	CAP,ELY 101-1C -E6
MAIN-P.W.Board			<a href="#">E800</a>	23S75244Y20	CAP,ELY 221-1C -E6
MAIN-P.W.Board			<a href="#">E801</a>	23S75244Y19	CAP,ELY 101-1C -E6
MAIN-P.W.Board			<a href="#">E802</a>	23S75244Y20	CAP,ELY 221-1C -E6
MAIN-P.W.Board			<a href="#">E803</a>	23S75244Y17	CAP,ELY 22R-1C -E2
MAIN-P.W.Board			<a href="#">E804</a>	23S75244Y18	CAP,ELY 47R-1C -E3
MAIN-P.W.Board			<a href="#">E805</a>	23S75244Y18	CAP,ELY 47R-1C -E3
MAIN-P.W.Board			<a href="#">E806</a>	23S65134W54	CAP,ELY 10R-1V(5)-E3
MAIN-P.W.Board			<a href="#">E807</a>	23S75244Y20	CAP,ELY 221-1C -E6
MAIN-P.W.Board			<a href="#">E808</a>	23S75244Y19	CAP,ELY 101-1C -E6
MAIN-P.W.Board			<a href="#">E809</a>	23S75244Y20	CAP,ELY 221-1C -E6
MAIN-P.W.Board			<a href="#">E810</a>	23S75244Y19	CAP,ELY 101-1C -E6
MAIN-P.W.Board			<a href="#">E811</a>	23S75244Y20	CAP,ELY 221-1C -E6
MAIN-P.W.Board			<a href="#">E812</a>	23S65134W44	CAP,ELY 22R-1E(6)-E6
MAIN-P.W.Board			<a href="#">E813</a>	23S75244Y20	CAP,ELY 221-1C -E6
MAIN-P.W.Board			<a href="#">E814</a>	23S75244Y20	CAP,ELY 221-1C -E6
MAIN-P.W.Board			<a href="#">E815</a>	23S75244Y28	CAP,ELY 101-1E -E6
MAIN-P.W.Board			<a href="#">E816</a>	23S75244Y19	CAP,ELY 101-1C -E6
MAIN-P.W.Board			<a href="#">E817</a>	23S75244Y19	CAP,ELY 101-1C -E6
MAIN-P.W.Board			<a href="#">E818</a>	23S65134W35	CAP,ELY 101-1C(8)-E6
MAIN-P.W.Board			<a href="#">E820</a>	23S65134W32	CAP,ELY 22R-1C(5)-E3
MAIN-P.W.Board			<a href="#">E821</a>	23S75244Y18	CAP,ELY 47R-1C -E3
MAIN-P.W.Board			<a href="#">IC101</a>	51-17583Z01	TEF6607T/V5 -SEE
MAIN-P.W.Board			<a href="#">IC102</a>	51-15224Z01	MFI341S2313 -SE2
MAIN-P.W.Board			<a href="#">IC301</a>	51-18346Z01	TB2986HQ -ZS
MAIN-P.W.Board			<a href="#">IC302</a>	51-05314Z01	BA4560RFVM-TR -SE1
MAIN-P.W.Board			<a href="#">IC303</a>	51-19762Z01	BD37543FS-E2 -SE9

P.W.Board	MIS	MODEL	Ref.	Parts No.	Parts Name
MAIN-P.W.Board			<a href="#">IC501</a>	83-22939Z29	V1.0_Fact2DIN_A
MAIN-P.W.Board			<a href="#">IC502</a>	51T65769Y01	BR24L16F-W-E2 -SE2
MAIN-P.W.Board			<a href="#">IC601</a>	51-20732Z01	ASSY,FC6000 PF810021
MAIN-P.W.Board			<a href="#">IC701</a>	51-12485Z07	IC,TMP92CD28AFG -QT
MAIN-P.W.Board			<a href="#">IC702</a>	51-16202Z01	TC94A92FG-301 -QT
MAIN-P.W.Board			<a href="#">IC703</a>	51-14737Z01	BD8226EFV-E2 -SE6
MAIN-P.W.Board			<a href="#">IC704</a>	51-11433Z01	RT9702AGB -CP
MAIN-P.W.Board			<a href="#">IC705</a>	51T15185Y02	TC7SH08FU,JF-L -CP
MAIN-P.W.Board			<a href="#">IC800</a>	51-07902Z02	NJM2871BF33-TE1 -CP
MAIN-P.W.Board			<a href="#">IC801</a>	51-13711Z01	TB2920HQ -ZS
MAIN-P.W.Board			<a href="#">IC802</a>	51-06963Z01	NJU7741F15-TE1 -CP
MAIN-P.W.Board			<a href="#">IC803</a>	51-04315Z22	BU4229G-TR -CP
MAIN-P.W.Board			<a href="#">IC804</a>	51-06963Z01	NJU7741F15-TE1 -CP
MAIN-P.W.Board			<a href="#">IC805</a>	51-02830Z01	BA7810HFP -NEA
MAIN-P.W.Board			<a href="#">IC806</a>	51-05862Z01	NJM2845DL1-33-TE1NE5
MAIN-P.W.Board			<a href="#">IC807</a>	51-05862Z01	NJM2845DL1-33-TE1NE5
MAIN-P.W.Board			<a href="#">IC808</a>	51-13565Z03	NJM2856DL3-33TE1-NE5
MAIN-P.W.Board			<a href="#">IC809</a>	51-13565Z01	NJM2856DL3-18TE1-NE5
MAIN-P.W.Board			<a href="#">IC811</a>	51T15194Y02	TC74VHCT08AFT,K -SE5
MAIN-P.W.Board			<a href="#">IC901</a>	51T93532F05	TC4S01F-TE85L -CP
MAIN-P.W.Board			<a href="#">JK301</a>	09-17989Z01	RCA,LPR1020-0600F-DB
MAIN-P.W.Board			<a href="#">JK901</a>	09-14149Z01	JAC,CK3-3.5-14D -DB
MAIN-P.W.Board			<a href="#">L101</a>	24T25164Y21	IND,FSLM2520 4R7J-CP
MAIN-P.W.Board			<a href="#">L103</a>	24T45482Y05	IND,LQH31HN R29J -CP
MAIN-P.W.Board			<a href="#">L104</a>	24T65110W16	IND,LK2125 1R0K -CP
MAIN-P.W.Board			<a href="#">L105</a>	24T65110W09	IND,LK2125 R27K -CP
MAIN-P.W.Board			<a href="#">L107</a>	24T65110W19	IND,LK2125 1R8K -CP
MAIN-P.W.Board			<a href="#">L108</a>	24T65645Y03	IND,LLM3225 561K -CP
MAIN-P.W.Board			<a href="#">L109</a>	24T65645Y03	IND,LLM3225 561K -CP
MAIN-P.W.Board			<a href="#">L110</a>	24-10967Z18	IND,LBM2016 3R3J -CP
MAIN-P.W.Board			<a href="#">L703</a>	24T95456W11	FBI,BLM18AG601SH1-CP
MAIN-P.W.Board			<a href="#">Q301</a>	48-13000Z05	TR,LTC124EUBFS8-TLCP
MAIN-P.W.Board			<a href="#">Q302</a>	48-13000Z01	TR,LTC114EUBFS8-TLCP
MAIN-P.W.Board			<a href="#">Q303</a>	48-13000Z05	TR,LTC124EUBFS8-TLCP
MAIN-P.W.Board			<a href="#">Q304</a>	48-04929Z02	TR,KRC102S-RTK -CP
MAIN-P.W.Board			<a href="#">Q305</a>	48-13000Z05	TR,LTC124EUBFS8-TLCP
MAIN-P.W.Board			<a href="#">Q306</a>	48T75180Y04	TR,IMH23-T110 -CP
MAIN-P.W.Board			<a href="#">Q308</a>	48T25737Y01	TR,UMD2N-TR -CP
MAIN-P.W.Board			<a href="#">Q309</a>	48-20092Z02	TR,DMG563020R -CP
MAIN-P.W.Board			<a href="#">Q701</a>	48-08605Z01	TR,2SA2048-TL -CP
MAIN-P.W.Board			<a href="#">Q702</a>	48-13000Z06	TR,LTC143XUBFS8-TLCP
MAIN-P.W.Board			<a href="#">Q703</a>	48-17707Z02	TR,DSA7003S0L -E2
MAIN-P.W.Board			<a href="#">Q704</a>	48-19949Z01	TR,DRC5143X -CP
MAIN-P.W.Board			<a href="#">Q705</a>	48T55462Y01	TR,2SB1132-QR-100-E2
MAIN-P.W.Board			<a href="#">Q709</a>	48-04940Z17	TR,KRA118S-RTK -CP
MAIN-P.W.Board			<a href="#">Q710</a>	48-13000Z01	TR,LTC114EUBFS8-TLCP
MAIN-P.W.Board			<a href="#">Q801</a>	48-20094Z02	TR,DMA561020R -CP



P.W.Board	MIS	MODEL	Ref.	Parts No.	Parts Name
MAIN-P.W.Board			<a href="#">Q804</a>	48T25737Y01	TR,UMD2N-TR -CP
MAIN-P.W.Board			<a href="#">Q805</a>	48-04929Z02	TR,KRC102S-RTK -CP
MAIN-P.W.Board			<a href="#">Q806</a>	48-09583Z04	TR,KTA1504S-GRRTK-CP
MAIN-P.W.Board			<a href="#">Q901</a>	48-09583Z04	TR,KTA1504S-GRRTK-CP
MAIN-P.W.Board			<a href="#">Q902</a>	48-13000Z01	TR,LTC114EUBFS8-TLCP
MAIN-P.W.Board			<a href="#">R274</a>	06S70072F05	RES,CP .10R-J-1/4-CP
MAIN-P.W.Board			<a href="#">R276</a>	06S15616Y14	RES,RK 474J 1/16 -CP
MAIN-P.W.Board			<a href="#">R277</a>	06S15616Y14	RES,RK 474J 1/16 -CP
MAIN-P.W.Board			<a href="#">R278</a>	06S15615Y25	RES,RK 101J 1/16 -CP
MAIN-P.W.Board			<a href="#">R279</a>	06S15615Y65	RES,RK 472J 1/16 -CP
MAIN-P.W.Board			<a href="#">R280</a>	06S70072F13	RES,CP .22R-J-1/4-CP
MAIN-P.W.Board			<a href="#">R281</a>	06S15615Y25	RES,RK 101J 1/16 -CP
MAIN-P.W.Board			<a href="#">R284</a>	06S15615Y25	RES,RK 101J 1/16 -CP
MAIN-P.W.Board			<a href="#">R285</a>	06S15616Y23	RES,RK JUMPER1/16-CP
MAIN-P.W.Board			<a href="#">R286</a>	06S15615Y73	RES,RK 103J 1/16 -CP
MAIN-P.W.Board			<a href="#">R301</a>	06S15615Y25	RES,RK 101J 1/16 -CP
MAIN-P.W.Board			<a href="#">R302</a>	06S45674W81	RES,RK 103J 1/10 -CP
MAIN-P.W.Board			<a href="#">R303</a>	06S70072F77	RES,CP .103-J-1/4-CP
MAIN-P.W.Board			<a href="#">R304</a>	06S15615Y37	RES,RK 331J 1/16 -CP
MAIN-P.W.Board			<a href="#">R305</a>	06S15615Y37	RES,RK 331J 1/16 -CP
MAIN-P.W.Board			<a href="#">R306</a>	06S15593Y71	RES,RK 822F 1/10 -CP
MAIN-P.W.Board			<a href="#">R307</a>	06S15593Y71	RES,RK 822F 1/10 -CP
MAIN-P.W.Board			<a href="#">R308</a>	06S15593Y71	RES,RK 822F 1/10 -CP
MAIN-P.W.Board			<a href="#">R309</a>	06S15593Y71	RES,RK 822F 1/10 -CP
MAIN-P.W.Board			<a href="#">R315</a>	06S45675W43	RES,RK JUMPER1/10-CP
MAIN-P.W.Board			<a href="#">R316</a>	06S45675W43	RES,RK JUMPER1/10-CP
MAIN-P.W.Board			<a href="#">R318</a>	06S45674W97	RES,RK 473J 1/10 -CP
MAIN-P.W.Board			<a href="#">R359</a>	06S15615Y73	RES,RK 103J 1/16 -CP
MAIN-P.W.Board			<a href="#">R360</a>	06S15615Y25	RES,RK 101J 1/16 -CP
MAIN-P.W.Board			<a href="#">R361</a>	06S15615Y25	RES,RK 101J 1/16 -CP
MAIN-P.W.Board			<a href="#">R362</a>	06S45675W43	RES,RK JUMPER1/10-CP
MAIN-P.W.Board			<a href="#">R363</a>	06S15615Y25	RES,RK 101J 1/16 -CP
MAIN-P.W.Board			<a href="#">R364</a>	06S15615Y49	RES,RK 102J 1/16 -CP
MAIN-P.W.Board			<a href="#">R371</a>	06S70072F29	RES,CP .101-J-1/4-CP
MAIN-P.W.Board			<a href="#">R373</a>	06S15615Y73	RES,RK 103J 1/16 -CP
MAIN-P.W.Board			<a href="#">R374</a>	06S15615Y33	RES,RK 221J 1/16 -CP
MAIN-P.W.Board			<a href="#">R375</a>	06S15615Y77	RES,RK 153J 1/16 -CP
MAIN-P.W.Board			<a href="#">R377</a>	06S15615Y73	RES,RK 103J 1/16 -CP
MAIN-P.W.Board			<a href="#">R378</a>	06S15615Y25	RES,RK 101J 1/16 -CP
MAIN-P.W.Board			<a href="#">R379</a>	06S15615Y69	RES,RK 682J 1/16 -CP
MAIN-P.W.Board			<a href="#">R380</a>	06S15615Y91	RES,RK 563J 1/16 -CP
MAIN-P.W.Board			<a href="#">R381</a>	06S15615Y91	RES,RK 563J 1/16 -CP
MAIN-P.W.Board			<a href="#">R382</a>	06S55365Y47	RES,RK 181J 1/10 -CP
MAIN-P.W.Board			<a href="#">R383</a>	06S55365Y47	RES,RK 181J 1/10 -CP
MAIN-P.W.Board			<a href="#">R384</a>	06S55365Y41	RES,RK 101J 1/10 -CP
MAIN-P.W.Board			<a href="#">R385</a>	06S55365Y41	RES,RK 101J 1/10 -CP
MAIN-P.W.Board			<a href="#">R500</a>	06S45675W43	RES,RK JUMPER1/10-CP

P.W.Board	MIS	MODEL	Ref.	Parts No.	Parts Name
MAIN-P.W.Board			<a href="#">R501</a>	06S45674W97	RES,RK 473J 1/10 -CP
MAIN-P.W.Board			<a href="#">R502</a>	06S15615Y25	RES,RK 101J 1/16 -CP
MAIN-P.W.Board			<a href="#">R503</a>	06S45674W33	RES,RK 101J 1/10 -CP
MAIN-P.W.Board			<a href="#">R504</a>	06S45674W97	RES,RK 473J 1/10 -CP
MAIN-P.W.Board			<a href="#">R505</a>	06S45674W97	RES,RK 473J 1/10 -CP
MAIN-P.W.Board			<a href="#">R506</a>	06S15616Y22	RES,RK 105J 1/16 -CP
MAIN-P.W.Board			<a href="#">R507</a>	06S15615Y81	RES,RK 223J 1/16 -CP
MAIN-P.W.Board			<a href="#">R508</a>	06S45674W41	RES,RK 221J 1/10 -CP
MAIN-P.W.Board			<a href="#">R512</a>	06S45674W33	RES,RK 101J 1/10 -CP
MAIN-P.W.Board			<a href="#">R513</a>	06S15615Y25	RES,RK 101J 1/16 -CP
MAIN-P.W.Board			<a href="#">R514</a>	06S45674W57	RES,RK 102J 1/10 -CP
MAIN-P.W.Board			<a href="#">R515</a>	06S45674W81	RES,RK 103J 1/10 -CP
MAIN-P.W.Board			<a href="#">R516</a>	06S15615Y59	RES,RK 272J 1/16 -CP
MAIN-P.W.Board			<a href="#">R517</a>	06S15615Y59	RES,RK 272J 1/16 -CP
MAIN-P.W.Board			<a href="#">R518</a>	06S15593Y73	RES,RK 103F 1/10 -CP
MAIN-P.W.Board			<a href="#">R519</a>	06S15593Y73	RES,RK 103F 1/10 -CP
MAIN-P.W.Board			<a href="#">R520</a>	06S15615Y25	RES,RK 101J 1/16 -CP
MAIN-P.W.Board			<a href="#">R521</a>	06S15615Y81	RES,RK 223J 1/16 -CP
MAIN-P.W.Board			<a href="#">R522</a>	06S45674W89	RES,RK 223J 1/10 -CP
MAIN-P.W.Board			<a href="#">R523</a>	06S15615Y59	RES,RK 272J 1/16 -CP
MAIN-P.W.Board			<a href="#">R524</a>	06S15615Y59	RES,RK 272J 1/16 -CP
MAIN-P.W.Board			<a href="#">R525</a>	06S15615Y59	RES,RK 272J 1/16 -CP
MAIN-P.W.Board			<a href="#">R526</a>	06S15615Y25	RES,RK 101J 1/16 -CP
MAIN-P.W.Board			<a href="#">R527</a>	06S15615Y81	RES,RK 223J 1/16 -CP
MAIN-P.W.Board			<a href="#">R528</a>	06S15615Y59	RES,RK 272J 1/16 -CP
MAIN-P.W.Board			<a href="#">R529</a>	06S15615Y81	RES,RK 223J 1/16 -CP
MAIN-P.W.Board			<a href="#">R530</a>	06S15615Y81	RES,RK 223J 1/16 -CP
MAIN-P.W.Board			<a href="#">R531</a>	06S15615Y25	RES,RK 101J 1/16 -CP
MAIN-P.W.Board			<a href="#">R533</a>	06S45674W57	RES,RK 102J 1/10 -CP
MAIN-P.W.Board			<a href="#">R535</a>	06S15615Y73	RES,RK 103J 1/16 -CP
MAIN-P.W.Board			<a href="#">R537</a>	06S45674W57	RES,RK 102J 1/10 -CP
MAIN-P.W.Board			<a href="#">R539</a>	06S15615Y25	RES,RK 101J 1/16 -CP
MAIN-P.W.Board			<a href="#">R540</a>	06S45674W57	RES,RK 102J 1/10 -CP
MAIN-P.W.Board			<a href="#">R542</a>	06S45674W57	RES,RK 102J 1/10 -CP
MAIN-P.W.Board			<a href="#">R543</a>	06S45674W57	RES,RK 102J 1/10 -CP
MAIN-P.W.Board			<a href="#">R544</a>	06S45674W57	RES,RK 102J 1/10 -CP
MAIN-P.W.Board			<a href="#">R545</a>	06S45674W57	RES,RK 102J 1/10 -CP
MAIN-P.W.Board			<a href="#">R547</a>	06S45674W57	RES,RK 102J 1/10 -CP
MAIN-P.W.Board			<a href="#">R548</a>	06S45674W57	RES,RK 102J 1/10 -CP
MAIN-P.W.Board			<a href="#">R549</a>	06S45674W57	RES,RK 102J 1/10 -CP
MAIN-P.W.Board			<a href="#">R555</a>	06S45674W57	RES,RK 102J 1/10 -CP
MAIN-P.W.Board			<a href="#">R556</a>	06S15615Y25	RES,RK 101J 1/16 -CP
MAIN-P.W.Board			<a href="#">R559</a>	06S15615Y25	RES,RK 101J 1/16 -CP
MAIN-P.W.Board			<a href="#">R566</a>	06S45674W57	RES,RK 102J 1/10 -CP
MAIN-P.W.Board			<a href="#">R600</a>	06S15615Y49	RES,RK 102J 1/16 -CP
MAIN-P.W.Board			<a href="#">R601</a>	06S70072F53	RES,CP .102-J-1/4-CP
MAIN-P.W.Board			<a href="#">R602</a>	06S70072F53	RES,CP .102-J-1/4-CP



P.W.Board	MIS	MODEL	Ref.	Parts No.	Parts Name
MAIN-P.W.Board			<a href="#">R603</a>	06S45674W33	RES,RK 101J 1/10 -CP
MAIN-P.W.Board			<a href="#">R604</a>	06S45674W81	RES,RK 103J 1/10 -CP
MAIN-P.W.Board			<a href="#">R605</a>	06S45674W33	RES,RK 101J 1/10 -CP
MAIN-P.W.Board			<a href="#">R607</a>	06S45674W33	RES,RK 101J 1/10 -CP
MAIN-P.W.Board			<a href="#">R610</a>	06S15615Y49	RES,RK 102J 1/16 -CP
MAIN-P.W.Board			<a href="#">R700</a>	06S45675W43	RES,RK JUMPER1/10-CP
MAIN-P.W.Board			<a href="#">R702</a>	06S15615Y89	RES,RK 473J 1/16 -CP
MAIN-P.W.Board			<a href="#">R703</a>	06S15615Y25	RES,RK 101J 1/16 -CP
MAIN-P.W.Board			<a href="#">R704</a>	06S15615Y25	RES,RK 101J 1/16 -CP
MAIN-P.W.Board			<a href="#">R705</a>	06S15615Y89	RES,RK 473J 1/16 -CP
MAIN-P.W.Board			<a href="#">R706</a>	06S15615Y65	RES,RK 472J 1/16 -CP
MAIN-P.W.Board			<a href="#">R707</a>	06S15615Y31	RES,RK 181J 1/16 -CP
MAIN-P.W.Board			<a href="#">R708</a>	06S15615Y25	RES,RK 101J 1/16 -CP
MAIN-P.W.Board			<a href="#">R709</a>	06S15615Y89	RES,RK 473J 1/16 -CP
MAIN-P.W.Board			<a href="#">R710</a>	06S15615Y89	RES,RK 473J 1/16 -CP
MAIN-P.W.Board			<a href="#">R712</a>	06S15615Y89	RES,RK 473J 1/16 -CP
MAIN-P.W.Board			<a href="#">R713</a>	06S15615Y89	RES,RK 473J 1/16 -CP
MAIN-P.W.Board			<a href="#">R714</a>	06S15615Y81	RES,RK 223J 1/16 -CP
MAIN-P.W.Board			<a href="#">R715</a>	06S45675W43	RES,RK JUMPER1/10-CP
MAIN-P.W.Board			<a href="#">R718</a>	06S15615Y81	RES,RK 223J 1/16 -CP
MAIN-P.W.Board			<a href="#">R719</a>	06S15615Y81	RES,RK 223J 1/16 -CP
MAIN-P.W.Board			<a href="#">R720</a>	06S15615Y81	RES,RK 223J 1/16 -CP
MAIN-P.W.Board			<a href="#">R721</a>	06S15615Y81	RES,RK 223J 1/16 -CP
MAIN-P.W.Board			<a href="#">R722</a>	06S15615Y77	RES,RK 153J 1/16 -CP
MAIN-P.W.Board			<a href="#">R723</a>	06S15615Y77	RES,RK 153J 1/16 -CP
MAIN-P.W.Board			<a href="#">R724</a>	06S45675W30	RES,RK 105J 1/10 -CP
MAIN-P.W.Board			<a href="#">R725</a>	06S15615Y81	RES,RK 223J 1/16 -CP
MAIN-P.W.Board			<a href="#">R726</a>	06S15615Y81	RES,RK 223J 1/16 -CP
MAIN-P.W.Board			<a href="#">R727</a>	06S15615Y49	RES,RK 102J 1/16 -CP
MAIN-P.W.Board			<a href="#">R728</a>	06S15615Y89	RES,RK 473J 1/16 -CP
MAIN-P.W.Board			<a href="#">R729</a>	06S15615Y89	RES,RK 473J 1/16 -CP
MAIN-P.W.Board			<a href="#">R731</a>	06S15615Y89	RES,RK 473J 1/16 -CP
MAIN-P.W.Board			<a href="#">R734</a>	06S15615Y89	RES,RK 473J 1/16 -CP
MAIN-P.W.Board			<a href="#">R735</a>	06S15615Y89	RES,RK 473J 1/16 -CP
MAIN-P.W.Board			<a href="#">R739</a>	06S15615Y89	RES,RK 473J 1/16 -CP
MAIN-P.W.Board			<a href="#">R740</a>	06S15615Y89	RES,RK 473J 1/16 -CP
MAIN-P.W.Board			<a href="#">R741</a>	06S15615Y89	RES,RK 473J 1/16 -CP
MAIN-P.W.Board			<a href="#">R743</a>	06S15615Y73	RES,RK 103J 1/16 -CP
MAIN-P.W.Board			<a href="#">R744</a>	06S15615Y43	RES,RK 561J 1/16 -CP
MAIN-P.W.Board			<a href="#">R745</a>	06S15615Y89	RES,RK 473J 1/16 -CP
MAIN-P.W.Board			<a href="#">R746</a>	06S15615Y89	RES,RK 473J 1/16 -CP
MAIN-P.W.Board			<a href="#">R760</a>	06S15615Y49	RES,RK 102J 1/16 -CP
MAIN-P.W.Board			<a href="#">R761</a>	06S15616Y22	RES,RK 105J 1/16 -CP
MAIN-P.W.Board			<a href="#">R762</a>	06S15615Y33	RES,RK 221J 1/16 -CP
MAIN-P.W.Board			<a href="#">R763</a>	06S15615Y89	RES,RK 473J 1/16 -CP
MAIN-P.W.Board			<a href="#">R764</a>	06S15615Y89	RES,RK 473J 1/16 -CP
MAIN-P.W.Board			<a href="#">R765</a>	06S15616Y18	RES,RK 684J 1/16 -CP





P.W.Board	MIS	MODEL	Ref.	Parts No.	Parts Name
MAIN-P.W.Board			<a href="#">R766</a>	06S15615Y77	RES,RK 153J 1/16 -CP
MAIN-P.W.Board			<a href="#">R767</a>	06S15615Y89	RES,RK 473J 1/16 -CP
MAIN-P.W.Board			<a href="#">R769</a>	06S15615Y83	RES,RK 273J 1/16 -CP
MAIN-P.W.Board			<a href="#">R770</a>	06S15615Y61	RES,RK 332J 1/16 -CP
MAIN-P.W.Board			<a href="#">R771</a>	06S55365Y33	RES,RK 47RJ 1/10 -CP
MAIN-P.W.Board			<a href="#">R772</a>	06S55365Y33	RES,RK 47RJ 1/10 -CP
MAIN-P.W.Board			<a href="#">R773</a>	06S15615Y25	RES,RK 101J 1/16 -CP
MAIN-P.W.Board			<a href="#">R774</a>	06S15615Y91	RES,RK 563J 1/16 -CP
MAIN-P.W.Board			<a href="#">R776</a>	06S15615Y63	RES,RK 392J 1/16 -CP
MAIN-P.W.Board			<a href="#">R777</a>	06S15615Y25	RES,RK 101J 1/16 -CP
MAIN-P.W.Board			<a href="#">R778</a>	06S15615Y89	RES,RK 473J 1/16 -CP
MAIN-P.W.Board			<a href="#">R779</a>	06S15615Y81	RES,RK 223J 1/16 -CP
MAIN-P.W.Board			<a href="#">R782</a>	06S15615Y67	RES,RK 562J 1/16 -CP
MAIN-P.W.Board			<a href="#">R783</a>	06S15615Y67	RES,RK 562J 1/16 -CP
MAIN-P.W.Board			<a href="#">R784</a>	06S15615Y79	RES,RK 183J 1/16 -CP
MAIN-P.W.Board			<a href="#">R785</a>	06S15615Y91	RES,RK 563J 1/16 -CP
MAIN-P.W.Board			<a href="#">R786</a>	06S15615Y25	RES,RK 101J 1/16 -CP
MAIN-P.W.Board			<a href="#">R787</a>	06S15615Y25	RES,RK 101J 1/16 -CP
MAIN-P.W.Board			<a href="#">R788</a>	06S70072F90	RES,CP .1R0-J-1/4-CP
MAIN-P.W.Board			<a href="#">R789</a>	06S15615Y91	RES,RK 563J 1/16 -CP
MAIN-P.W.Board			<a href="#">R790</a>	06S15616Y23	RES,RK JUMPER1/16-CP
MAIN-P.W.Board			<a href="#">R791</a>	06S15616Y23	RES,RK JUMPER1/16-CP
MAIN-P.W.Board			<a href="#">R795</a>	06S15615Y73	RES,RK 103J 1/16 -CP
MAIN-P.W.Board			<a href="#">R796</a>	06S15615Y89	RES,RK 473J 1/16 -CP
MAIN-P.W.Board			<a href="#">R798</a>	06S15615Y89	RES,RK 473J 1/16 -CP
MAIN-P.W.Board			<a href="#">R802</a>	06S55365Y41	RES,RK 101J 1/10 -CP
MAIN-P.W.Board			<a href="#">R804</a>	06S15615Y25	RES,RK 101J 1/16 -CP
MAIN-P.W.Board			<a href="#">R805</a>	06S15615Y89	RES,RK 473J 1/16 -CP
MAIN-P.W.Board			<a href="#">R806</a>	06S15615Y25	RES,RK 101J 1/16 -CP
MAIN-P.W.Board			<a href="#">R807</a>	06S55365Y41	RES,RK 101J 1/10 -CP
MAIN-P.W.Board			<a href="#">R808</a>	06S15615Y89	RES,RK 473J 1/16 -CP
MAIN-P.W.Board			<a href="#">R809</a>	06S55365Y41	RES,RK 101J 1/10 -CP
MAIN-P.W.Board			<a href="#">R811</a>	06S65415Y49	RES,RK 104F 1/16 -CP
MAIN-P.W.Board			<a href="#">R812</a>	06S35095Y01	RES,RK 333J 1/4 -CP
MAIN-P.W.Board			<a href="#">R813</a>	06S35083Y34	RES,RK 562F 1/4 -CP
MAIN-P.W.Board			<a href="#">R814</a>	06S65415Y34	RES,RK 562F 1/16 -CP
MAIN-P.W.Board			<a href="#">R815</a>	06S65415Y43	RES,RK 333F 1/16 -CP
MAIN-P.W.Board			<a href="#">R816</a>	06S65415Y42	RES,RK 273F 1/16 -CP
MAIN-P.W.Board			<a href="#">R817</a>	06S70072F77	RES,CP .103-J-1/4-CP
MAIN-P.W.Board			<a href="#">R818</a>	06S65415Y41	RES,RK 223F 1/16 -CP
MAIN-P.W.Board			<a href="#">R820</a>	06S55365Y63	RES,RK 821J 1/10 -CP
MAIN-P.W.Board			<a href="#">R821</a>	06S15593Y77	RES,RK 153F 1/10 -CP
MAIN-P.W.Board			<a href="#">R822</a>	06S15593Y41	RES,RK 471F 1/10 -CP
MAIN-P.W.Board			<a href="#">R823</a>	06S15615Y49	RES,RK 102J 1/16 -CP
MAIN-P.W.Board			<a href="#">R826</a>	06-02713Z18	RES,RK 153D 1/16 -CP
MAIN-P.W.Board			<a href="#">R827</a>	06-02713Z29	RES,RK 561D 1/16 -CP
MAIN-P.W.Board			<a href="#">R828</a>	06-02713Z65	RES,RK 512D 1/16 -CP

P.W.Board	MIS	MODEL	Ref.	Parts No.	Parts Name
MAIN-P.W.Board			<a href="#">R832</a>	06S45675W06	RES,RK 104J 1/10 -CP
MAIN-P.W.Board			<a href="#">R833</a>	06S45674W97	RES,RK 473J 1/10 -CP
MAIN-P.W.Board			<a href="#">R834</a>	06S45674W97	RES,RK 473J 1/10 -CP
MAIN-P.W.Board			<a href="#">R836</a>	06S15615Y49	RES,RK 102J 1/16 -CP
MAIN-P.W.Board			<a href="#">R837</a>	06S15615Y13	RES,RK 33RJ 1/16 -CP
MAIN-P.W.Board			<a href="#">R838</a>	06S55365Y83	RES,RK 562J 1/10 -CP
MAIN-P.W.Board			<a href="#">R839</a>	06S55365Y69	RES,RK 152J 1/10 -CP
MAIN-P.W.Board			<a href="#">R840</a>	06S55365Y78	RES,RK 362J 1/10 -CP
MAIN-P.W.Board			<a href="#">R848</a>	06S15615Y57	RES,RK 222J 1/16 -CP
MAIN-P.W.Board			<a href="#">R849</a>	06S15615Y81	RES,RK 223J 1/16 -CP
MAIN-P.W.Board			<a href="#">R850</a>	06S15615Y89	RES,RK 473J 1/16 -CP
MAIN-P.W.Board			<a href="#">R902</a>	06S45675W43	RES,RK JUMPER1/10-CP
MAIN-P.W.Board			<a href="#">R904</a>	06S45675W43	RES,RK JUMPER1/10-CP
MAIN-P.W.Board			<a href="#">R906</a>	06S15593Y85	RES,RK 333F 1/10 -CP
MAIN-P.W.Board			<a href="#">R907</a>	06S45675W30	RES,RK 105J 1/10 -CP
MAIN-P.W.Board			<a href="#">R908</a>	06S45674W89	RES,RK 223J 1/10 -CP
MAIN-P.W.Board			<a href="#">R909</a>	06S70072F29	RES,CP .101-J-1/4-CP
MAIN-P.W.Board			<a href="#">R910</a>	06S45674W65	RES,RK 222J 1/10 -CP
MAIN-P.W.Board			<a href="#">R911</a>	06S45674W69	RES,RK 332J 1/10 -CP
MAIN-P.W.Board			<a href="#">R912</a>	06S15593Y81	RES,RK 223F 1/10 -CP
MAIN-P.W.Board			<a href="#">R913</a>	06S15593Y49	RES,RK 102F 1/10 -CP
MAIN-P.W.Board			<a href="#">RA501</a>	06S15771Y37	RES,ARYEXB28V103J-CP
MAIN-P.W.Board			<a href="#">RA502</a>	06S15771Y13	RES,ARYEXB28V101J-CP
MAIN-P.W.Board			<a href="#">RA503</a>	06S15771Y13	RES,ARYEXB28V101J-CP
MAIN-P.W.Board			<a href="#">RA504</a>	06S15771Y13	RES,ARYEXB28V101J-CP
MAIN-P.W.Board			<a href="#">RA505</a>	06S15771Y13	RES,ARYEXB28V101J-CP
MAIN-P.W.Board			<a href="#">RA506</a>	06S15771Y13	RES,ARYEXB28V101J-CP
MAIN-P.W.Board			<a href="#">RA701</a>	06S15771Y45	RES,ARYEXB28V473J-CP
MAIN-P.W.Board			<a href="#">RA702</a>	06S15771Y45	RES,ARYEXB28V473J-CP
MAIN-P.W.Board			<a href="#">RA703</a>	06S15771Y33	RES,ARY 472J 4 -CP
MAIN-P.W.Board			<a href="#">RA704</a>	06S15771Y33	RES,ARY 472J 4 -CP
MAIN-P.W.Board			<a href="#">RA706</a>	06S15771Y45	RES,ARYEXB28V473J-CP
MAIN-P.W.Board			<a href="#">RA707</a>	06S15771Y13	RES,ARYEXB28V101J-CP
MAIN-P.W.Board			<a href="#">RA708</a>	06S15771Y13	RES,ARYEXB28V101J-CP
MAIN-P.W.Board			<a href="#">RA709</a>	06S15771Y13	RES,ARYEXB28V101J-CP
MAIN-P.W.Board			<a href="#">RA710</a>	06S15771Y13	RES,ARYEXB28V101J-CP
MAIN-P.W.Board			<a href="#">RA711</a>	06S15771Y13	RES,ARYEXB28V101J-CP
MAIN-P.W.Board			<a href="#">RA712</a>	06S15771Y13	RES,ARYEXB28V101J-CP
MAIN-P.W.Board			<a href="#">RA713</a>	06S15771Y45	RES,ARYEXB28V473J-CP
MAIN-P.W.Board			<a href="#">RA717</a>	06S15771Y45	RES,ARYEXB28V473J-CP
MAIN-P.W.Board			<a href="#">RA718</a>	06S15771Y49	RES,ARYEXB28V104J-CP
MAIN-P.W.Board			<a href="#">SA101</a>	48-00954Z01	VST,CSA30C201M-T -CP
MAIN-P.W.Board			<a href="#">VT102</a>	24-17683Z01	COIL,IFT1 FM 5CCE-E6
MAIN-P.W.Board			<a href="#">VT301</a>	24-02502Z02	ASSY,W277A001 -DB
MAIN-P.W.Board			<a href="#">XL101</a>	91-16024Z03	XTL,AT-41CD2 4.00-E9
MAIN-P.W.Board			<a href="#">XL501</a>	91-16093Z02	XTL,NX3215SA 32.7-E1
MAIN-P.W.Board			<a href="#">XL502</a>	91-16024Z08	XTL,AT-41CD2 8.19-E9

P.W.Board	MIS	MODEL	Ref.	Parts No.	Parts Name
MAIN-P.W.Board			<a href="#">XL701</a>	91-16024Z09	XTL,AT-41CD2 9.00-E9
MAIN-P.W.Board			<a href="#">XL702</a>	91-16093Z01	XTL,NX3215SA 32.7-E1
MAIN-P.W.Board			<a href="#">XL703</a>	91-16024Z07	XTL,AT-41CD2 16.9-E9
MAIN-P.W.Board			<a href="#">Z702</a>	91T75196Y08	EMI,BK1005HW601 -CP
MAIN-P.W.Board			<a href="#">ZD301</a>	48-02592Z01	DIO,ZEN Z5W27VJ -EA
MAIN-P.W.Board			<a href="#">ZD500</a>	48-21149Z19	DIO,ZEN DZ2J051L0LCP
FRONT-P.W.Board			<a href="#">C401</a>	08S65667Y03	CAP,CER 474KX5R1A-CP
FRONT-P.W.Board			<a href="#">C402</a>	08S45676W89	CAP,CER 473K-B1E -CP
FRONT-P.W.Board			<a href="#">C403</a>	08S45676W89	CAP,CER 473K-B1E -CP
FRONT-P.W.Board			<a href="#">C404</a>	08S35374W12	CAP,CER 106K-B0J -CP
FRONT-P.W.Board			<a href="#">C405</a>	08S45676W65	CAP,CER.222K-B1H -CP
FRONT-P.W.Board			<a href="#">C406</a>	08S45676W65	CAP,CER.222K-B1H -CP
FRONT-P.W.Board			<a href="#">C407</a>	08S45676W65	CAP,CER.222K-B1H -CP
FRONT-P.W.Board			<a href="#">C408</a>	08S45231Y28	CAP,CER 181J-CH1H-CP
FRONT-P.W.Board			<a href="#">C409</a>	08S45676W65	CAP,CER.222K-B1H -CP
FRONT-P.W.Board			<a href="#">C410</a>	08S45677W58	CAP,CER 821J-CH1H-CP
FRONT-P.W.Board			<a href="#">C411</a>	08S65667Y03	CAP,CER 474KX5R1A-CP
FRONT-P.W.Board			<a href="#">C415</a>	08S45676W89	CAP,CER 473K-B1E -CP
FRONT-P.W.Board			<a href="#">C416</a>	08T81833F07	CAP,CER 105K-B1C -CP
FRONT-P.W.Board			<a href="#">C417</a>	08S45676W65	CAP,CER.222K-B1H -CP
FRONT-P.W.Board			<a href="#">CH401</a>	09-06261Z07	BTB,IMSA9850S-20Y-EQ
FRONT-P.W.Board			<a href="#">D404</a>	48-07015Z01	DIO,KDS160-RTK -CP
FRONT-P.W.Board			<a href="#">D406</a>	48-12230Z01	DIO,KDS226-RTK -CP
FRONT-P.W.Board			<a href="#">D411</a>	48-17547Z01	DIO,DA3J101F0L -CP
FRONT-P.W.Board			<a href="#">D412</a>	48-17547Z01	DIO,DA3J101F0L -CP
FRONT-P.W.Board			<a href="#">D413</a>	48-17547Z01	DIO,DA3J101F0L -CP
FRONT-P.W.Board			<a href="#">IC401</a>	51-10867Z01	PT6575C-TQ-L -QT
FRONT-P.W.Board			<a href="#">IC402</a>	51-18623Z01	PNJ4L02M -NE1
FRONT-P.W.Board			<a href="#">JK401</a>	09-18872Z01	JAC,1850383000322-DB
FRONT-P.W.Board			<a href="#">LCD401</a>	65-21757Z01	LCD,TG6758M0TTN-FZ
FRONT-P.W.Board			<a href="#">LD400</a>	48-22133Z01	LED,ARY QB.L.021 -DB
FRONT-P.W.Board			<a href="#">LD401</a>	48-14200Z02	LED,BLU LNJ926W8C-CP
FRONT-P.W.Board			<a href="#">LD402</a>	48-14200Z02	LED,BLU LNJ926W8C-CP
FRONT-P.W.Board			<a href="#">LD403</a>	48-14200Z02	LED,BLU LNJ926W8C-CP
FRONT-P.W.Board			<a href="#">LD404</a>	48-14200Z02	LED,BLU LNJ926W8C-CP
FRONT-P.W.Board			<a href="#">LD405</a>	48-14200Z02	LED,BLU LNJ926W8C-CP
FRONT-P.W.Board			<a href="#">LD406</a>	48-14200Z02	LED,BLU LNJ926W8C-CP
FRONT-P.W.Board			<a href="#">LD407</a>	48-14200Z02	LED,BLU LNJ926W8C-CP
FRONT-P.W.Board			<a href="#">LD408</a>	48-14200Z02	LED,BLU LNJ926W8C-CP
FRONT-P.W.Board			<a href="#">LD409</a>	48-14200Z02	LED,BLU LNJ926W8C-CP
FRONT-P.W.Board			<a href="#">LD410</a>	48-14200Z02	LED,BLU LNJ926W8C-CP
FRONT-P.W.Board			<a href="#">LD411</a>	48-14200Z02	LED,BLU LNJ926W8C-CP
FRONT-P.W.Board			<a href="#">LD412</a>	48-14200Z02	LED,BLU LNJ926W8C-CP
FRONT-P.W.Board			<a href="#">LD413</a>	48-14200Z02	LED,BLU LNJ926W8C-CP
FRONT-P.W.Board			<a href="#">LD414</a>	48-14200Z02	LED,BLU LNJ926W8C-CP
FRONT-P.W.Board			<a href="#">LD415</a>	48-14200Z02	LED,BLU LNJ926W8C-CP
FRONT-P.W.Board			<a href="#">LD416</a>	48-14200Z02	LED,BLU LNJ926W8C-CP

P.W.Board	MIS	MODEL	Ref.	Parts No.	Parts Name
FRONT-P.W.Board			<a href="#">LD469</a>	48-14200Z02	LED,BLU LNJ926W8C-CP
FRONT-P.W.Board			<a href="#">Q401</a>	48-13059Z01	TR,KTC2875-B-RTK -CP
FRONT-P.W.Board			<a href="#">Q402</a>	48-21758Z01	TR,DSC2001S0L -CP
FRONT-P.W.Board			<a href="#">Q403</a>	48-04929Z05	TR,KRC105S-RTK -CP
FRONT-P.W.Board			<a href="#">Q422</a>	48-21758Z01	TR,DSC2001S0L -CP
FRONT-P.W.Board			<a href="#">Q423</a>	48-04929Z05	TR,KRC105S-RTK -CP
FRONT-P.W.Board			<a href="#">Q428</a>	48-13059Z01	TR,KTC2875-B-RTK -CP
FRONT-P.W.Board			<a href="#">Q429</a>	48-20092Z01	TR,DMG563010R -CP
FRONT-P.W.Board			<a href="#">Q430</a>	48-20092Z01	TR,DMG563010R -CP
FRONT-P.W.Board			<a href="#">Q432</a>	48-21758Z01	TR,DSC2001S0L -CP
FRONT-P.W.Board			<a href="#">R401</a>	06S70072F21	RES,CP .47R-J-1/4-CP
FRONT-P.W.Board			<a href="#">R407</a>	06S15593Y87	RES,RK 393F 1/10 -CP
FRONT-P.W.Board			<a href="#">R408</a>	06S15593Y87	RES,RK 393F 1/10 -CP
FRONT-P.W.Board			<a href="#">R410</a>	06S65415Y33	RES,RK 472F 1/16 -CP
FRONT-P.W.Board			<a href="#">R411</a>	06S65415Y33	RES,RK 472F 1/16 -CP
FRONT-P.W.Board			<a href="#">R412</a>	06S65415Y33	RES,RK 472F 1/16 -CP
FRONT-P.W.Board			<a href="#">R413</a>	06S45674W73	RES,RK 472J 1/10 -CP
FRONT-P.W.Board			<a href="#">R414</a>	06S70072F25	RES,CP .68R-J-1/4-CP
FRONT-P.W.Board			<a href="#">R415</a>	06S35084Y39	RES,RK 153F 1/8 -CP
FRONT-P.W.Board			<a href="#">R416</a>	06S35084Y44	RES,RK 393F 1/8 -CP
FRONT-P.W.Board			<a href="#">R417</a>	06S35084Y78	RES,RK 132F 1/8 -CP
FRONT-P.W.Board			<a href="#">R418</a>	06S35084Y39	RES,RK 153F 1/8 -CP
FRONT-P.W.Board			<a href="#">R419</a>	06S35084Y44	RES,RK 393F 1/8 -CP
FRONT-P.W.Board			<a href="#">R420</a>	06S35084Y78	RES,RK 132F 1/8 -CP
FRONT-P.W.Board			<a href="#">R421</a>	06S35084Y28	RES,RK 182F 1/8 -CP
FRONT-P.W.Board			<a href="#">R422</a>	06S70072F23	RES,CP .56R-J-1/4-CP
FRONT-P.W.Board			<a href="#">R423</a>	06S70072F17	RES,CP .33R-J-1/4-CP
FRONT-P.W.Board			<a href="#">R424</a>	06S70072F17	RES,CP .33R-J-1/4-CP
FRONT-P.W.Board			<a href="#">R425</a>	06S35084Y31	RES,RK 332F 1/8 -CP
FRONT-P.W.Board			<a href="#">R426</a>	06S55363Y65	RES,RK 102J 1/8 -CP
FRONT-P.W.Board			<a href="#">R427</a>	06S55363Y65	RES,RK 102J 1/8 -CP
FRONT-P.W.Board			<a href="#">R428</a>	06S35084Y29	RES,RK 222F 1/8 -CP
FRONT-P.W.Board			<a href="#">R429</a>	06S55363Y65	RES,RK 102J 1/8 -CP
FRONT-P.W.Board			<a href="#">R430</a>	06S45674W57	RES,RK 102J 1/10 -CP
FRONT-P.W.Board			<a href="#">R431</a>	06S35084Y64	RES,RK 432F 1/8 -CP
FRONT-P.W.Board			<a href="#">R432</a>	06S70072F41	RES,CP .331-J-1/4-CP
FRONT-P.W.Board			<a href="#">R433</a>	06S35084Y68	RES,RK 752F 1/8 -CP
FRONT-P.W.Board			<a href="#">R434</a>	06S70072F43	RES,CP .391-J-1/4-CP
FRONT-P.W.Board			<a href="#">R435</a>	06S70072F41	RES,CP .331-J-1/4-CP
FRONT-P.W.Board			<a href="#">R436</a>	06S70072F47	RES,CP .561-J-1/4-CP
FRONT-P.W.Board			<a href="#">R440</a>	06S35084Y28	RES,RK 182F 1/8 -CP
FRONT-P.W.Board			<a href="#">R441</a>	06S35084Y31	RES,RK 332F 1/8 -CP
FRONT-P.W.Board			<a href="#">R442</a>	06S35084Y29	RES,RK 222F 1/8 -CP
FRONT-P.W.Board			<a href="#">R443</a>	06S45675W43	RES,RK JUMPER1/10-CP
FRONT-P.W.Board			<a href="#">R445</a>	06S55363Y65	RES,RK 102J 1/8 -CP
FRONT-P.W.Board			<a href="#">R446</a>	06S35084Y64	RES,RK 432F 1/8 -CP
FRONT-P.W.Board			<a href="#">R448</a>	06S70072F42	RES,CP .361-J-1/4-CP

P.W.Board	MIS	MODEL	Ref.	Parts No.	Parts Name
FRONT-P.W.Board			<a href="#">R449</a>	06S70072F39	RES,CP .271-J-1/4-CP
FRONT-P.W.Board			<a href="#">R450</a>	06S70072F41	RES,CP .331-J-1/4-CP
FRONT-P.W.Board			<a href="#">R451</a>	06S70072F41	RES,CP .331-J-1/4-CP
FRONT-P.W.Board			<a href="#">R452</a>	06S45674W57	RES,RK 102J 1/10 -CP
FRONT-P.W.Board			<a href="#">R453</a>	06S35084Y68	RES,RK 752F 1/8 -CP
FRONT-P.W.Board			<a href="#">R461</a>	06S70072F39	RES,CP .271-J-1/4-CP
FRONT-P.W.Board			<a href="#">R462</a>	06S45675W43	RES,RK JUMPER1/10-CP
FRONT-P.W.Board			<a href="#">R465</a>	06S55363Y65	RES,RK 102J 1/8 -CP
FRONT-P.W.Board			<a href="#">R466</a>	06S55363Y65	RES,RK 102J 1/8 -CP
FRONT-P.W.Board			<a href="#">R467</a>	06S70072F29	RES,CP .101-J-1/4-CP
FRONT-P.W.Board			<a href="#">R470</a>	06S70072F47	RES,CP .561-J-1/4-CP
FRONT-P.W.Board			<a href="#">R471</a>	06S70072F49	RES,CP .681-J-1/4-CP
FRONT-P.W.Board			<a href="#">R473</a>	06S45674W73	RES,RK 472J 1/10 -CP
FRONT-P.W.Board			<a href="#">R474</a>	06S70072F25	RES,CP .68R-J-1/4-CP
FRONT-P.W.Board			<a href="#">R475</a>	06S45675W43	RES,RK JUMPER1/10-CP
FRONT-P.W.Board			<a href="#">R479</a>	06S45674W65	RES,RK 222J 1/10 -CP
FRONT-P.W.Board			<a href="#">R483</a>	06S64995F29	RES,RK 101J 1/8 -CP
FRONT-P.W.Board			<a href="#">R484</a>	06S64995F29	RES,RK 101J 1/8 -CP
FRONT-P.W.Board			<a href="#">R485</a>	06S64995F29	RES,RK 101J 1/8 -CP
FRONT-P.W.Board			<a href="#">RA401</a>	06S15771Y25	RES,ARYEXB28V102J-CP
FRONT-P.W.Board			<a href="#">SK401</a>	09-19382Z01	SKT,CM-V105 -DB
FRONT-P.W.Board			<a href="#">SW401</a>	40T65353Y01	SW,TACT SKRSPACE010E2
FRONT-P.W.Board			<a href="#">SW402</a>	40T65353Y01	SW,TACT SKRSPACE010E2
FRONT-P.W.Board			<a href="#">SW403</a>	40T65353Y01	SW,TACT SKRSPACE010E2
FRONT-P.W.Board			<a href="#">SW404</a>	40T65353Y01	SW,TACT SKRSPACE010E2
FRONT-P.W.Board			<a href="#">SW405</a>	40T65353Y01	SW,TACT SKRSPACE010E2
FRONT-P.W.Board			<a href="#">SW406</a>	40T65353Y01	SW,TACT SKRSPACE010E2
FRONT-P.W.Board			<a href="#">SW407</a>	40T65353Y01	SW,TACT SKRSPACE010E2
FRONT-P.W.Board			<a href="#">SW408</a>	40-10735Z02	ENC,EC12D1524405 -DB
FRONT-P.W.Board			<a href="#">SW409</a>	40T65353Y01	SW,TACT SKRSPACE010E2
FRONT-P.W.Board			<a href="#">SW410</a>	40T65353Y01	SW,TACT SKRSPACE010E2
FRONT-P.W.Board			<a href="#">SW411</a>	40T65353Y01	SW,TACT SKRSPACE010E2
FRONT-P.W.Board			<a href="#">SW412</a>	40T65353Y01	SW,TACT SKRSPACE010E2
FRONT-P.W.Board			<a href="#">SW413</a>	40T65353Y01	SW,TACT SKRSPACE010E2
FRONT-P.W.Board			<a href="#">SW414</a>	40T65353Y01	SW,TACT SKRSPACE010E2
FRONT-P.W.Board			<a href="#">SW415</a>	40T65353Y01	SW,TACT SKRSPACE010E2
FRONT-P.W.Board			<a href="#">SW416</a>	40T65353Y01	SW,TACT SKRSPACE010E2
FRONT-P.W.Board			<a href="#">SW417</a>	40T65353Y01	SW,TACT SKRSPACE010E2
FRONT-P.W.Board			<a href="#">SW418</a>	40T65353Y01	SW,TACT SKRSPACE010E2
FRONT-P.W.Board			<a href="#">SW419</a>	40T65353Y01	SW,TACT SKRSPACE010E2
FRONT-P.W.Board			<a href="#">SW420</a>	40T65353Y01	SW,TACT SKRSPACE010E2
FRONT-P.W.Board			<a href="#">TML400</a>	29T45687Y02	OG-363040 -E5
FRONT-P.W.Board			<a href="#">Z401</a>	91-14147Z01	EMI,ACM2012H-900 -CP
FRONT-P.W.Board			<a href="#">ZD401</a>	48-18196Z02	DIO,ZEN DZ2S051M0LCP
FRONT-P.W.Board			<a href="#">ZD402</a>	48-18196Z02	DIO,ZEN DZ2S051M0LCP
SW(DP33U8BV)- P.W.Board			<a href="#">CB101</a>	09-09314Z01	FFC,IMSA9664S-11Y-EQ

P.W.Board	MIS	MODEL	Ref.	Parts No.	Parts Name
SW(DP33U8BV)- P.W.Board			<a href="#">PT1</a>	48-04836Z01	PHT,TR PS1191RB22-CP
SW(DP33U8BV)- P.W.Board			<a href="#">PT2</a>	48-04836Z01	PHT,TR PS1191RB22-CP
SW(DP33U8BV)- P.W.Board			<a href="#">PT3</a>	48-04836Z01	PHT,TR PS1191RB22-CP
SW(DP33U8BV)- P.W.Board			<a href="#">SW1</a>	40T15494Y16	SW,DETCT SPVG1103-E6
FPC.PHOTO.VE- P.W.Board			C101	08S45677W42	CAP,CER.181J-CH1H-CP
FPC.PHOTO.VE- P.W.Board			C102	08S45677W42	CAP,CER.181J-CH1H-CP
FPC.PHOTO.VE- P.W.Board			C103	08S45677W42	CAP,CER.181J-CH1H-CP
FPC.PHOTO.VE- P.W.Board			LD101	48-01591Z01	LED,AN1105W-1-TR -CP
FPC.PHOTO.VE- P.W.Board			LD102	48-01591Z01	LED,AN1105W-1-TR -CP
FPC.PHOTO.VE- P.W.Board			LD103	48-01591Z01	LED,AN1105W-1-TR -CP
FPC.PHOTO.VE- P.W.Board			R101	06S45674W51	RES,RK 561J 1/10 -CP
FPC.PHOTO.VE- P.W.Board			R102	06S45674W51	RES,RK 561J 1/10 -CP
FPC.PHOTO.VE- P.W.Board			R103	06S45674W51	RES,RK 561J 1/10 -CP
Miscellaneous			<a href="#">HD1</a>	EP-12502Z06	EP21A96NP
Miscellaneous			<a href="#">M1</a>	66-19371Z75	ASSY,SPDL MTR 8BV
Miscellaneous			<a href="#">M2</a>	66-13908Z44	ASSY,LD-SLED MTR AOTA 8BV