

Packing Method View

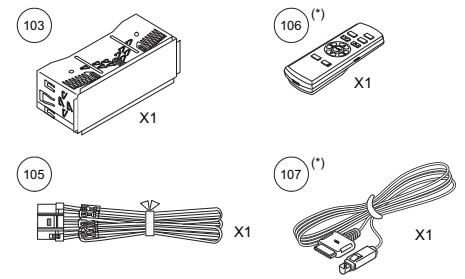

(*) NOTE
 102-4 106 107 : CDA-9884Li Only

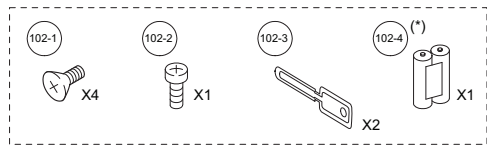
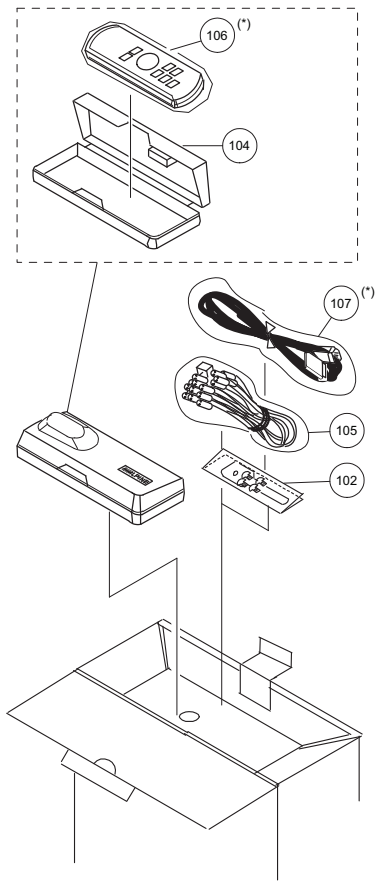
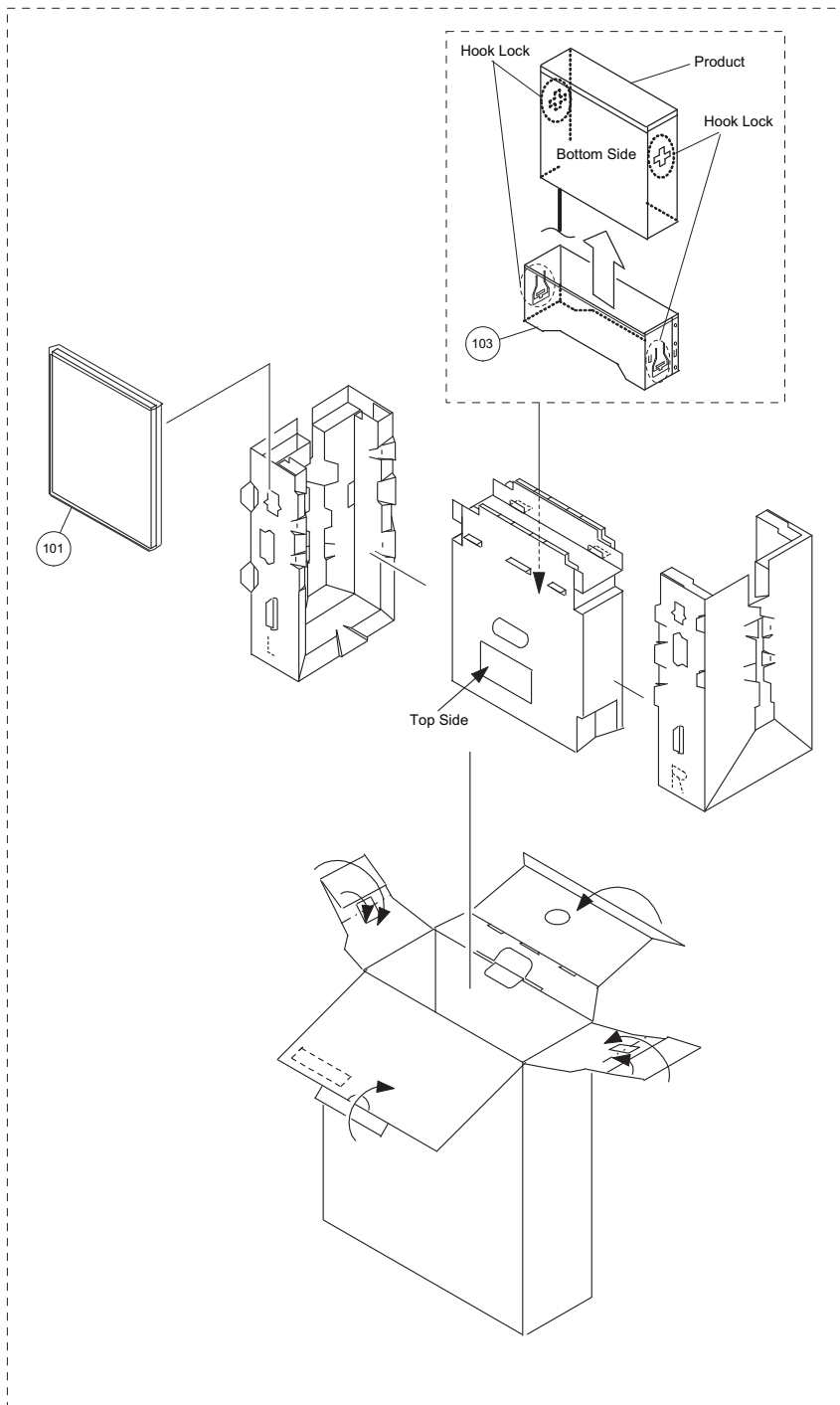
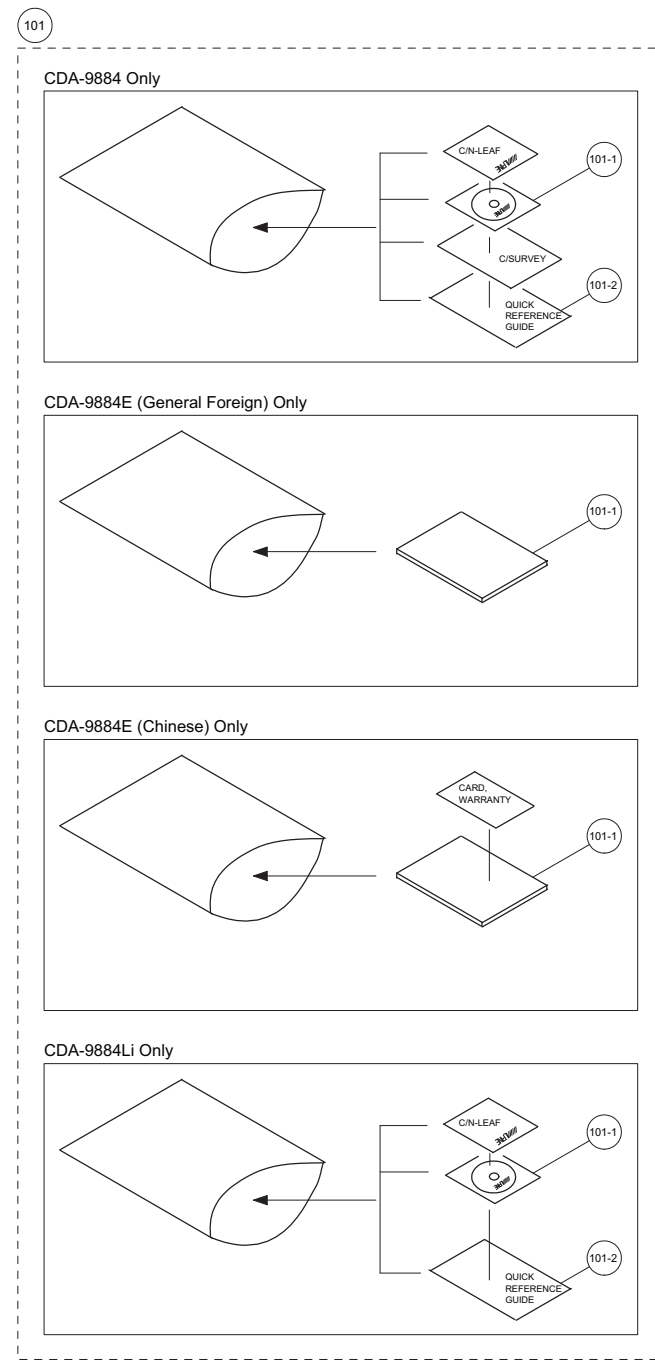

MODEL	Symbol No.	Parts No.	Description
#1	101-1	68-10334Z04	O/M-CDROM FLAT
\$1	101-1	68-09359Z41	O/M AAO AOTA
%1	101-1	68-09359Z42	O/M AOCH AOTA
&1	101-1	68-10334Z04	O/M-CDROM FLAT
#1	101-2	68-09359Z57	C/N-QRG AOAM AOTA
&1	101-2	68-09359Z60	C/N-QRG AOL AOTA
	102-1	03S60820Y16	SCR,MCH 5X8 ZN A
	102-2	03S70691Y11	SCR,B-T 1.7X8 ZB A
	102-3	07-01964Z01	BKT,RELEASE
&1	102-4	60T55630W01	BAT,MGN R03(NB)UM-4
	103	15-01970Z01	CASE,INNER
	104	15-09616Z02	CARRYING,CASE ASSY
	105	09-02256Z04	ASSY,ANIC-0008-04B
&1	106	97-02291Z01	ASSY,SBPF00001A
&1	107	09-05915Z01	ASSY,ANID-0002-02A

Mark Model Code

#1 CDA-9884 Only,

\$1 CDA-9884E (General Foreign) Only,

%1 CDA-9884E (Chinese) Only,

&1 CDA-9884Li Only,

Others:Common.

NOTE:The part that has not PART NUMBER will not be supplied.

P.W.Board	MIS	MODEL	Ref.	Parts No.	Parts Name
MAIN-P.W.Board			ANT001	09-06103Z01	ASSY,ANID-0035-01A
MAIN-P.W.Board			C002	08S45676W80	CAP,CER 223K-B1E -CP
MAIN-P.W.Board			C004	08S45677W42	CAP,CER.181J-CH1H-CP
MAIN-P.W.Board			C005	08S45677W54	CAP,CER 561J-CH1H-CP
MAIN-P.W.Board			C006	08S65128F88	CAP,CER 104K-B1H -CP
MAIN-P.W.Board			C007	08S45677W42	CAP,CER.181J-CH1H-CP
MAIN-P.W.Board			C009	08S65128F78	CAP,CER.223K-B1H -CP
MAIN-P.W.Board			C011	08S45676W93	CAP,CER 224K-B1A -CP
MAIN-P.W.Board			C012	08S45677W44	CAP,CER.221J-CH1H-CP
MAIN-P.W.Board			C013	08S45677W36	CAP,CER.101J-CH1H-CP
MAIN-P.W.Board			C101	08S45676W73	CAP,CER.103K-B1H -CP
MAIN-P.W.Board			C102	08S45676W85	CAP,CER 104K-B1C -CP
MAIN-P.W.Board			C104	08S45676W84	CAP,CER 683K-B1C -CP
MAIN-P.W.Board			C105	08S65667Y05	CAP,CER 105KX5R1A-CP
MAIN-P.W.Board			C106	08S45677W36	CAP,CER.101J-CH1H-CP
MAIN-P.W.Board			C107	08S45677W36	CAP,CER.101J-CH1H-CP
MAIN-P.W.Board			C108	08S65671Y01	CAP,CER 226KX5R1A-CP
MAIN-P.W.Board			C201	08S45676W73	CAP,CER.103K-B1H -CP
MAIN-P.W.Board			C206	08S65676Y03	CAP,CER 225KX7R1C-CP
MAIN-P.W.Board			C207	08S65676Y05	CAP,CER 105KX7R1E-CP
MAIN-P.W.Board			C208	08S65676Y05	CAP,CER 105KX7R1E-CP
MAIN-P.W.Board			C209	08S65676Y05	CAP,CER 105KX7R1E-CP
MAIN-P.W.Board			C301	08-02764Z03	CAP,TF 224K-1E -CP
MAIN-P.W.Board			C302	08-02764Z03	CAP,TF 224K-1E -CP
MAIN-P.W.Board			C303	08-02764Z03	CAP,TF 224K-1E -CP
MAIN-P.W.Board			C304	08-02764Z03	CAP,TF 224K-1E -CP
MAIN-P.W.Board			C306	08S45676W83	CAP,CER 473K-B1C -CP
MAIN-P.W.Board			C307	08T81833F07	CAP,CER 105K-B1C -CP
MAIN-P.W.Board			C318	08S45676W73	CAP,CER.103K-B1H -CP
MAIN-P.W.Board			C5000	08S45539Y04	CAP,CER 103KX7R2J-CP
MAIN-P.W.Board			C5002	08S45676W80	CAP,CER 223K-B1E -CP
MAIN-P.W.Board			C5003	08S45539Y04	CAP,CER 103KX7R2J-CP
MAIN-P.W.Board			C5005	08S45676W65	CAP,CER.222K-B1H -CP
MAIN-P.W.Board			C5006	08S45676W65	CAP,CER.222K-B1H -CP
MAIN-P.W.Board			C5007	08S45676W65	CAP,CER.222K-B1H -CP
MAIN-P.W.Board			C5008	08S60102F44	CAP,CER 474K-B1E -CP
MAIN-P.W.Board			C5009	08S45677W36	CAP,CER.101J-CH1H-CP
MAIN-P.W.Board			C504	08S45677W18	CAP,CER.18RJ-CH1H-CP
MAIN-P.W.Board			C505	08S45677W18	CAP,CER.18RJ-CH1H-CP

Mark Model Code

#1 CDA-9884 Only,

\$1 CDA-9884E (General Foreign) Only,

%1 CDA-9884E (Chinese) Only,

&1 CDA-9884Li Only,

Others:Common.

NOTE:The part that has not PART NUMBER will not be supplied.

P.W.Board	MIS	MODEL	Ref.	Parts No.	Parts Name
MAIN-P.W.Board			C506	08S45677W20	CAP,CER.22RJ-CH1H-CP
MAIN-P.W.Board			C507	08S45677W20	CAP,CER.22RJ-CH1H-CP
MAIN-P.W.Board			C508	08S45677W60	CAP,CER 102J-CH1H-CP
MAIN-P.W.Board			C509	08S45677W60	CAP,CER 102J-CH1H-CP
MAIN-P.W.Board			C510	08S35374W01	CAP,CER 104K-B1E-CP
MAIN-P.W.Board			C511	08S65128F90	CAP,CER 473K-B1H -CP
MAIN-P.W.Board			C512	08S45676W80	CAP,CER 223K-B1E -CP
MAIN-P.W.Board			C513	08T81833F07	CAP,CER 105K-B1C -CP
MAIN-P.W.Board			C514	08S45677W22	CAP,CER.27RJ-CH1H-CP
MAIN-P.W.Board			C515	08S45677W36	CAP,CER.101J-CH1H-CP
MAIN-P.W.Board			C516	08S35374W12	CAP,CER 106K-B0J -CP
MAIN-P.W.Board			C517	08S45676W80	CAP,CER 223K-B1E -CP
MAIN-P.W.Board			C518	08S45676W80	CAP,CER 223K-B1E -CP
MAIN-P.W.Board			C603	08S45676W80	CAP,CER 223K-B1E -CP
MAIN-P.W.Board			C604	08S35350Y04	CAP,CER 105K-B1C -CP
MAIN-P.W.Board			C608	08S35374W01	CAP,CER 104K-B1E-CP
MAIN-P.W.Board			C609	08S65128F78	CAP,CER.223K-B1H -CP
MAIN-P.W.Board			C610	08S45676W65	CAP,CER.222K-B1H -CP
MAIN-P.W.Board			C611	08S45677W36	CAP,CER.101J-CH1H-CP
MAIN-P.W.Board			C700	08S45676W80	CAP,CER 223K-B1E -CP
MAIN-P.W.Board			C707	08S45677W20	CAP,CER.22RJ-CH1H-CP
MAIN-P.W.Board			C708	08S45677W20	CAP,CER.22RJ-CH1H-CP
MAIN-P.W.Board			C709	08S45677W20	CAP,CER.22RJ-CH1H-CP
MAIN-P.W.Board			C710	08S45677W20	CAP,CER.22RJ-CH1H-CP
MAIN-P.W.Board			C711	08S65674Y05	CAP,CER 105KX5R1C-CP
MAIN-P.W.Board			C712	08S65674Y05	CAP,CER 105KX5R1C-CP
MAIN-P.W.Board			C713	08S65674Y05	CAP,CER 105KX5R1C-CP
MAIN-P.W.Board			C714	08S65674Y05	CAP,CER 105KX5R1C-CP
MAIN-P.W.Board			C715	08S65674Y05	CAP,CER 105KX5R1C-CP
MAIN-P.W.Board			C716	08S65674Y05	CAP,CER 105KX5R1C-CP
MAIN-P.W.Board			C717	08S65674Y05	CAP,CER 105KX5R1C-CP
MAIN-P.W.Board			C718	08S65674Y05	CAP,CER 105KX5R1C-CP
MAIN-P.W.Board			C719	08S45677W20	CAP,CER.22RJ-CH1H-CP
MAIN-P.W.Board			C720	08S45677W20	CAP,CER.22RJ-CH1H-CP
MAIN-P.W.Board			C721	08S45677W20	CAP,CER.22RJ-CH1H-CP
MAIN-P.W.Board			C722	08S45677W20	CAP,CER.22RJ-CH1H-CP
MAIN-P.W.Board			C723	08S45676W80	CAP,CER 223K-B1E -CP
MAIN-P.W.Board		\$1	C800	08S45676W85	CAP,CER 104K-B1C -CP
MAIN-P.W.Board		%1	C800	08S45676W85	CAP,CER 104K-B1C -CP

Mark Model Code

#1 CDA-9884 Only,

\$1 CDA-9884E (General Foreign) Only,

%1 CDA-9884E (Chinese) Only,

&1 CDA-9884Li Only,

Others:Common.

NOTE:The part that has not PART NUMBER will not be supplied.

P.W.Board	MIS	MODEL	Ref.	Parts No.	Parts Name
MAIN-P.W.Board			C801	08T55390W34	CAP,TF 274J-1H -R5
MAIN-P.W.Board			C802	08S65667Y01	CAP,CER 224KX5R1C-CP
MAIN-P.W.Board			C804	08S45676W73	CAP,CER.103K-B1H -CP
MAIN-P.W.Board			C805	08S45676W85	CAP,CER 104K-B1C -CP
MAIN-P.W.Board			C806	08S65667Y01	CAP,CER 224KX5R1C-CP
MAIN-P.W.Board			C809	08S45676W85	CAP,CER 104K-B1C -CP
MAIN-P.W.Board			C810	08S45676W85	CAP,CER 104K-B1C -CP
MAIN-P.W.Board			C811	08S45676W85	CAP,CER 104K-B1C -CP
MAIN-P.W.Board			C812	08S45676W85	CAP,CER 104K-B1C -CP
MAIN-P.W.Board			C814	08S45676W85	CAP,CER 104K-B1C -CP
MAIN-P.W.Board			C815	08S45676W85	CAP,CER 104K-B1C -CP
MAIN-P.W.Board			C816	08S45539Y04	CAP,CER 103KX7R2J-CP
MAIN-P.W.Board			C817	08S45539Y04	CAP,CER 103KX7R2J-CP
MAIN-P.W.Board			C819	08S65128F78	CAP,CER.223K-B1H -CP
MAIN-P.W.Board		\$1	C823	08S45676W85	CAP,CER 104K-B1C -CP
MAIN-P.W.Board		%1	C823	08S45676W85	CAP,CER 104K-B1C -CP
MAIN-P.W.Board		\$1	C825	08S45676W85	CAP,CER 104K-B1C -CP
MAIN-P.W.Board		%1	C825	08S45676W85	CAP,CER 104K-B1C -CP
MAIN-P.W.Board		\$1	C829	08T81833F13	CAP,CER 106K-B1C -CP
MAIN-P.W.Board		%1	C829	08T81833F13	CAP,CER 106K-B1C -CP
MAIN-P.W.Board		\$1	C832	08S45232Y11	CAP,CER 103K-B1C -CP
MAIN-P.W.Board		%1	C832	08S45232Y11	CAP,CER 103K-B1C -CP
MAIN-P.W.Board		\$1	C833	08S45232Y13	CAP,CER 223K-B1C -CP
MAIN-P.W.Board		%1	C833	08S45232Y13	CAP,CER 223K-B1C -CP
MAIN-P.W.Board			C834	08S65128F78	CAP,CER.223K-B1H -CP
MAIN-P.W.Board			C835	08S35374W01	CAP,CER 104K-B1E-CP
MAIN-P.W.Board		\$1	C837	08S45676W80	CAP,CER 223K-B1E -CP
MAIN-P.W.Board		%1	C837	08S45676W80	CAP,CER 223K-B1E -CP
MAIN-P.W.Board			CB101	09-11475Z01	BTB,IMSA9852B-22Y-EK
MAIN-P.W.Board			CB5001	09T03498K11	WTB,53253-1110 -DB
MAIN-P.W.Board			CB801	24-02502Z02	ASSY,W277A001 -DB
MAIN-P.W.Board		\$1	CB802	09-05986Z04	WTB,SM05B-PASS-TBTE9
MAIN-P.W.Board		%1	CB802	09-05986Z04	WTB,SM05B-PASS-TBTE9
MAIN-P.W.Board			CH501	09T75236Y20	BTB,BTFW20R-3RSTA-EJ
MAIN-P.W.Board			D001	48T85357W01	DIO,1PS226 -CP
MAIN-P.W.Board			D101	48T45701Y01	DIO,MA2S728-TX -CP
MAIN-P.W.Board			D106	48T75527Y01	DIO,1SR154-400 -E1
MAIN-P.W.Board			D107	48T75527Y01	DIO,1SR154-400 -E1
MAIN-P.W.Board			D301	48-07015Z01	DIO,KDS160-RTK -CP

Mark Model Code

#1 CDA-9884 Only,

\$1 CDA-9884E (General Foreign) Only,

%1 CDA-9884E (Chinese) Only,

&1 CDA-9884Li Only,

Others:Common.

NOTE:The part that has not PART NUMBER will not be supplied.

P.W.Board	MIS	MODEL	Ref.	Parts No.	Parts Name
MAIN-P.W.Board			D302	48T95572W01	DIO,SHT MA736-TX -E1
MAIN-P.W.Board			D305	48T95572W01	DIO,SHT MA736-TX -E1
MAIN-P.W.Board			D330	48T25651W01	DIO,MA152WA -CP
MAIN-P.W.Board			D331	48T25651W01	DIO,MA152WA -CP
MAIN-P.W.Board			D332	48T25651W01	DIO,MA152WA -CP
MAIN-P.W.Board			D5000	48T75527Y01	DIO,1SR154-400 -E1
MAIN-P.W.Board			D5004	48T85357W01	DIO,1PS226 -CP
MAIN-P.W.Board			D501	48T25651W02	DIO,MA152WK-TX -CP
MAIN-P.W.Board			D502	48T25651W01	DIO,MA152WA -CP
MAIN-P.W.Board			D503	48T68828F11	DIO,1SS133 -RH
MAIN-P.W.Board			D605	48T25651W02	DIO,MA152WK-TX -CP
MAIN-P.W.Board		\$1	D800	48T75527Y01	DIO,1SR154-400 -E1
MAIN-P.W.Board		%1	D800	48T75527Y01	DIO,1SR154-400 -E1
MAIN-P.W.Board			D801	48T75527Y01	DIO,1SR154-400 -E1
MAIN-P.W.Board			D803	48T75527Y01	DIO,1SR154-400 -E1
MAIN-P.W.Board			D804	48T75527Y01	DIO,1SR154-400 -E1
MAIN-P.W.Board			D805	48T75527Y01	DIO,1SR154-400 -E1
MAIN-P.W.Board			D806	48T44813F03	DIO,MA165 -R5
MAIN-P.W.Board			D807	48T75527Y01	DIO,1SR154-400 -E1
MAIN-P.W.Board		\$1	D808	48-08988Z01	VST,EZJZ0V800AA -CP
MAIN-P.W.Board		%1	D808	48-08988Z01	VST,EZJZ0V800AA -CP
MAIN-P.W.Board		\$1	D809	48-08988Z01	VST,EZJZ0V800AA -CP
MAIN-P.W.Board		%1	D809	48-08988Z01	VST,EZJZ0V800AA -CP
MAIN-P.W.Board			DIN801	09T55071W11	CON,TCP9389-11 -DT
MAIN-P.W.Board			E001	23S75372W05	CAP,ELY 22R-1C -R2
MAIN-P.W.Board			E101	23-02519Z15	CAP,FC 22R-1C-C -E3
MAIN-P.W.Board			E102	23S65134W23	CAP,ELY 101-1A(6)-E6
MAIN-P.W.Board			E103	23T55378W03	CAP,KMG 471-1A -R2
MAIN-P.W.Board			E201	23S65134W31	CAP,ELY 10R-1C(4)-E2
MAIN-P.W.Board			E202	23S65134W41	CAP,ELY 4R7-1E(3)-E2
MAIN-P.W.Board			E203	23S65134W41	CAP,ELY 4R7-1E(3)-E2
MAIN-P.W.Board			E204	23S65134W51	CAP,ELY 2R2-1V(3)-E2
MAIN-P.W.Board			E205	23S65134W64	CAP,ELY R47-1H(3)-E2
MAIN-P.W.Board			E206	23S65134W32	CAP,ELY 22R-1C(5)-E3
MAIN-P.W.Board			E210	23S65134W41	CAP,ELY 4R7-1E(3)-E2
MAIN-P.W.Board			E211	23S65134W41	CAP,ELY 4R7-1E(3)-E2
MAIN-P.W.Board			E212	23S65134W51	CAP,ELY 2R2-1V(3)-E2
MAIN-P.W.Board			E213	23S65134W64	CAP,ELY R47-1H(3)-E2
MAIN-P.W.Board			E301	23S65134W41	CAP,ELY 4R7-1E(3)-E2

Mark Model Code

#1 CDA-9884 Only,

\$1 CDA-9884E (General Foreign) Only,

%1 CDA-9884E (Chinese) Only,

&1 CDA-9884Li Only,

Others:Common.

NOTE:The part that has not PART NUMBER will not be supplied.

P.W.Board	MIS	MODEL	Ref.	Parts No.	Parts Name
MAIN-P.W.Board			E302	23S65134W41	CAP,ELY 4R7-1E(3)-E2
MAIN-P.W.Board			E303	23S65134W41	CAP,ELY 4R7-1E(3)-E2
MAIN-P.W.Board			E304	23S65134W41	CAP,ELY 4R7-1E(3)-E2
MAIN-P.W.Board			E305	23S65134W34	CAP,ELY 47R-1C(6)-E6
MAIN-P.W.Board			E306	23S65134W65	CAP,ELY 1R0-1H(3)-E2
MAIN-P.W.Board			E307	23S65134W32	CAP,ELY 22R-1C(5)-E3
MAIN-P.W.Board			E308	23S65134W53	CAP,ELY 4R7-1V(4)-E2
MAIN-P.W.Board			E309	23S65134W51	CAP,ELY 2R2-1V(3)-E2
MAIN-P.W.Board			E310	23S65134W51	CAP,ELY 2R2-1V(3)-E2
MAIN-P.W.Board			E311	23S65134W51	CAP,ELY 2R2-1V(3)-E2
MAIN-P.W.Board			E312	23S65134W51	CAP,ELY 2R2-1V(3)-E2
MAIN-P.W.Board			E313	23S65134W51	CAP,ELY 2R2-1V(3)-E2
MAIN-P.W.Board			E314	23S65134W51	CAP,ELY 2R2-1V(3)-E2
MAIN-P.W.Board			E5000	23S65134W45	CAP,ELY 33R-1E(6)-E6
MAIN-P.W.Board			E501	23S45639Y03	CAP,ELY 331-0J -R2
MAIN-P.W.Board			E502	23S45639Y08	CAP,ELY 22R-1C -R2
MAIN-P.W.Board			E602	23S45639Y22	CAP,ELY 1R0-1H -R2
MAIN-P.W.Board			E700	23S65134W31	CAP,ELY 10R-1C(4)-E2
MAIN-P.W.Board			E701	23S65134W65	CAP,ELY 1R0-1H(3)-E2
MAIN-P.W.Board			E706	23S65134W32	CAP,ELY 22R-1C(5)-E3
MAIN-P.W.Board		\$1	E800	23T65679Y11	CAP,CD 47R-0J -E2
MAIN-P.W.Board		%1	E800	23T65679Y11	CAP,CD 47R-0J -E2
MAIN-P.W.Board			E801	23S65134W36	CAP,ELY 221-1C(8)-EA
MAIN-P.W.Board		\$1	E802	23S75244Y22	CAP,ELY 471-1C -EA
MAIN-P.W.Board		%1	E802	23S75244Y22	CAP,ELY 471-1C -EA
MAIN-P.W.Board			E803	23S75244Y14	CAP,ELY 681-1A -EA
MAIN-P.W.Board			E804	23T75325Y01	CAP,VB 332-1C +
MAIN-P.W.Board		\$1	E806	23S75244Y19	CAP,ELY 101-1C -E6
MAIN-P.W.Board		%1	E806	23S75244Y19	CAP,ELY 101-1C -E6
MAIN-P.W.Board		\$1	E809	23S75244Y22	CAP,ELY 471-1C -EA
MAIN-P.W.Board		%1	E809	23S75244Y22	CAP,ELY 471-1C -EA
MAIN-P.W.Board			F801	65T75477Y13	FUSE,CCP2E 4.0A -CP
MAIN-P.W.Board			IC101	51T15362Y01	TC74HCT7007AFTP2-SE6
MAIN-P.W.Board			IC102	51-05862Z01	NJM2845DL1-33-TE1NE5
MAIN-P.W.Board			IC103	51T15191Y01	TC74VHC08FT-EL -SE5
MAIN-P.W.Board			IC201	51-07764Z01	TDA7417 -QE6
MAIN-P.W.Board			IC301	51T65184Y01	TB2901H -ZS
MAIN-P.W.Board			IC5001	51-11615Z01	BD7300EFV-E2 -SE6
MAIN-P.W.Board			IC5002	51T25183Y02	TC7SET08FU-EL -CP

Mark Model Code

#1 CDA-9884 Only,



\$1 CDA-9884E (General Foreign) Only,

%1 CDA-9884E (Chinese) Only,

&1 CDA-9884Li Only,

Others:Common.

NOTE:The part that has not PART NUMBER will not be supplied.

P.W.Board	MIS	MODEL	Ref.	Parts No.	Parts Name
MAIN-P.W.Board		#1	IC501	53-12773Z22	OFL,V3.00MFAL703A
MAIN-P.W.Board		\$1	IC501	51-12421Z01	IC,M30626MJPXXXGP-QT
MAIN-P.W.Board		%1	IC501	51-12421Z01	IC,M30626MJPXXXGP-QT
MAIN-P.W.Board		&1	IC501	51-12421Z01	IC,M30626MJPXXXGP-QT
MAIN-P.W.Board			IC502	51T75063Y06	BD5228G-TR -CP
MAIN-P.W.Board			IC503	51-09594Z01	KIC7W04FK-RTK -CP
MAIN-P.W.Board			IC504	51-10494Z01	KIA393F-EL -SE2
MAIN-P.W.Board			IC602	51T93532F05	TC4S01F-TE85L -CP
MAIN-P.W.Board			IC700	51T15420Y01	BA4560F-E2 -SE2
MAIN-P.W.Board			IC703	51T93340F02	NJM2060V-TE2 -SE2
MAIN-P.W.Board			IC801	51T65147Y01	HA13165 -ZS
MAIN-P.W.Board		\$1	IC803	51-02248Z01	BD9781HFP-TR -NEA
MAIN-P.W.Board		%1	IC803	51-02248Z01	BD9781HFP-TR -NEA
MAIN-P.W.Board		\$1	IC804	51-11433Z01	RT9702AGB -CP
MAIN-P.W.Board		%1	IC804	51-11433Z01	RT9702AGB -CP
MAIN-P.W.Board			JK1200	09-11352Z01	RCA,YKC21-4816N -DB
MAIN-P.W.Board			JK601	09T03156K01	JAC,CK-3.5-14 -DB
MAIN-P.W.Board			L001	24T25164Y21	IND,FSLM2520 4R7J-CP
MAIN-P.W.Board			L002	24T35286Y02	IND,MG56 332J -DB
MAIN-P.W.Board			L003	24T16403W29	COI,IND.15R-M -CP
MAIN-P.W.Board			L101	24-04485Z06	IND,7E10H 101M -EA
MAIN-P.W.Board		\$1	L800	24-04484Z06	IND,7B12HJ 101M -EA
MAIN-P.W.Board		%1	L800	24-04484Z06	IND,7B12HJ 101M -EA
MAIN-P.W.Board			Q002	48-09581Z04	TR,KTA1505S-GRRTK-CP
MAIN-P.W.Board			Q003	48-04929Z01	TR,KRC101S-RTK -CP
MAIN-P.W.Board			Q101	48T45594W12	TR ,XN1A312 -TX-CP
MAIN-P.W.Board			Q301	48-04929Z02	TR,KRC102S-RTK -CP
MAIN-P.W.Board			Q302	48-04929Z02	TR,KRC102S-RTK -CP
MAIN-P.W.Board			Q304	48T45594W12	TR ,XN1A312 -TX-CP
MAIN-P.W.Board			Q305	48-04929Z03	TR,KRC103S-RTK -CP
MAIN-P.W.Board			Q306	48-04929Z03	TR,KRC103S-RTK -CP
MAIN-P.W.Board			Q307	48T25317Y01	TR,XN0F256-TX -CP
MAIN-P.W.Board			Q308	48T25317Y01	TR,XN0F256-TX -CP
MAIN-P.W.Board			Q309	48T25317Y01	TR,XN0F256-TX -CP
MAIN-P.W.Board			Q5003	48T45594W12	TR ,XN1A312 -TX-CP
MAIN-P.W.Board			Q501	48-09583Z04	TR,KTA1504S-GRRTK-CP
MAIN-P.W.Board			Q502	48T52438F01	TR ,2SD601A-RS/TX-CP
MAIN-P.W.Board			Q503	48-04940Z03	TR,KRA103S-RTK -CP
MAIN-P.W.Board			Q504	48T45594W16	TR,XN1A311-TX -CP

Mark Model Code

#1 CDA-9884 Only,

\$1 CDA-9884E (General Foreign) Only,

%1 CDA-9884E (Chinese) Only,

&1 CDA-9884Li Only,

Others:Common.

NOTE:The part that has not PART NUMBER will not be supplied.

P.W.Board	MIS	MODEL	Ref.	Parts No.	Parts Name
MAIN-P.W.Board			Q603	48-05471Z01	TR,XP0NG8A00-L -CP
MAIN-P.W.Board			Q604	48-04929Z03	TR,KRC103S-RTK -CP
MAIN-P.W.Board			Q610	48T93828F04	TR,2SD1994A-S-TA -RD
MAIN-P.W.Board			Q611	48T45594W16	TR,XN1A311-TX -CP
MAIN-P.W.Board			Q613	48-09583Z04	TR,KTA1504S-GRRTK-CP
MAIN-P.W.Board			Q614	48-04929Z02	TR,KRC102S-RTK -CP
MAIN-P.W.Board			Q705	48-04929Z06	TR,KRC106S-RTK -CP
MAIN-P.W.Board			Q706	48T63788F04	TR,2SD1328-T-TX -CP
MAIN-P.W.Board			Q801	48-04929Z01	TR,KRC101S-RTK -CP
MAIN-P.W.Board			Q802	48-09583Z04	TR,KTA1504S-GRRTK-CP
MAIN-P.W.Board			Q803	48-04929Z01	TR,KRC101S-RTK -CP
MAIN-P.W.Board			Q804	48T45594W16	TR,XN1A311-TX -CP
MAIN-P.W.Board			Q805	48T45594W12	TR ,XN1A312 -TX-CP
MAIN-P.W.Board			Q806	48-04929Z03	TR,KRC103S-RTK -CP
MAIN-P.W.Board			Q807	48T75031Y03	TR,2SB1440-S -E2
MAIN-P.W.Board			Q808	48-04929Z05	TR,KRC105S-RTK -CP
MAIN-P.W.Board			Q809	48T93828F04	TR,2SD1994A-S-TA -RD
MAIN-P.W.Board			Q810	48T45594W16	TR,XN1A311-TX -CP
MAIN-P.W.Board		\$1	Q811	48T45594W08	TR ,XN1212 -TX-CP
MAIN-P.W.Board		%1	Q811	48T45594W08	TR ,XN1212 -TX-CP
MAIN-P.W.Board			Q817	48T93828F04	TR,2SD1994A-S-TA -RD
MAIN-P.W.Board			R002	06S70072F05	RES,CP .10R-J-1/4-CP
MAIN-P.W.Board			R003	06S55363Y49	RES,RK 221J 1/8 -CP
MAIN-P.W.Board			R004	06S55365Y65	RES,RK 102J 1/10 -CP
MAIN-P.W.Board			R005	06S55366Y14	RES,RK 104J 1/10 -CP
MAIN-P.W.Board			R006	06S55366Y14	RES,RK 104J 1/10 -CP
MAIN-P.W.Board			R007	06S55365Y89	RES,RK 103J 1/10 -CP
MAIN-P.W.Board			R008	06S55365Y65	RES,RK 102J 1/10 -CP
MAIN-P.W.Board			R009	06S55365Y41	RES,RK 101J 1/10 -CP
MAIN-P.W.Board			R010	06S55365Y41	RES,RK 101J 1/10 -CP
MAIN-P.W.Board			R014	06S55365Y97	RES,RK 223J 1/10 -CP
MAIN-P.W.Board			R015	06S45675W43	RES,RK JUMPER1/10-CP
MAIN-P.W.Board			R016	06S55365Y89	RES,RK 103J 1/10 -CP
MAIN-P.W.Board			R017	06S55361Y71	RES,RK 182J 1/4 -CP
MAIN-P.W.Board			R101	06S45674W97	RES,RK 473J 1/10 -CP
MAIN-P.W.Board			R102	06S45674W97	RES,RK 473J 1/10 -CP
MAIN-P.W.Board			R103	06S45674W97	RES,RK 473J 1/10 -CP
MAIN-P.W.Board			R104	06S45674W97	RES,RK 473J 1/10 -CP
MAIN-P.W.Board			R105	06S45674W89	RES,RK 223J 1/10 -CP

Mark Model Code

#1 CDA-9884 Only,

\$1 CDA-9884E (General Foreign) Only,

%1 CDA-9884E (Chinese) Only,

&1 CDA-9884Li Only,

Others:Common.

NOTE:The part that has not PART NUMBER will not be supplied.

P.W.Board	MIS	MODEL	Ref.	Parts No.	Parts Name
MAIN-P.W.Board			R106	06S45674W97	RES,RK 473J 1/10 -CP
MAIN-P.W.Board			R107	06S45674W89	RES,RK 223J 1/10 -CP
MAIN-P.W.Board			R111	06S55366Y12	RES,RK 823J 1/10 -CP
MAIN-P.W.Board			R112	06S45674W89	RES,RK 223J 1/10 -CP
MAIN-P.W.Board			R113	06S45674W97	RES,RK 473J 1/10 -CP
MAIN-P.W.Board			R114	06S45674W97	RES,RK 473J 1/10 -CP
MAIN-P.W.Board			R115	06S45674W97	RES,RK 473J 1/10 -CP
MAIN-P.W.Board			R116	06S45674W33	RES,RK 101J 1/10 -CP
MAIN-P.W.Board			R117	06S45674W33	RES,RK 101J 1/10 -CP
MAIN-P.W.Board			R118	06S45674W97	RES,RK 473J 1/10 -CP
MAIN-P.W.Board			R201	06S35083Y45	RES,RK 473F 1/4 -CP
MAIN-P.W.Board			R202	06S35083Y45	RES,RK 473F 1/4 -CP
MAIN-P.W.Board			R203	06S35083Y45	RES,RK 473F 1/4 -CP
MAIN-P.W.Board			R204	06S64995F29	RES,RK 101J 1/8 -CP
MAIN-P.W.Board			R205	06S64995F29	RES,RK 101J 1/8 -CP
MAIN-P.W.Board			R206	06S64995F29	RES,RK 101J 1/8 -CP
MAIN-P.W.Board			R207	06S64995F29	RES,RK 101J 1/8 -CP
MAIN-P.W.Board			R301	06S45674W81	RES,RK 103J 1/10 -CP
MAIN-P.W.Board			R302	06S45674W81	RES,RK 103J 1/10 -CP
MAIN-P.W.Board			R303	06S55362Y06	RES,RK 473J 1/4 -CP
MAIN-P.W.Board			R304	06S70072F29	RES,CP .101-J-1/4-CP
MAIN-P.W.Board			R306	06S45674W85	RES,RK 153J 1/10 -CP
MAIN-P.W.Board			R307	06S45674W33	RES,RK 101J 1/10 -CP
MAIN-P.W.Board			R308	06S45674W41	RES,RK 221J 1/10 -CP
MAIN-P.W.Board			R309	06S45674W81	RES,RK 103J 1/10 -CP
MAIN-P.W.Board			R328	06S55366Y09	RES,RK 623J 1/10 -CP
MAIN-P.W.Board			R329	06S55366Y09	RES,RK 623J 1/10 -CP
MAIN-P.W.Board			R330	06S55366Y09	RES,RK 623J 1/10 -CP
MAIN-P.W.Board			R331	06S55366Y09	RES,RK 623J 1/10 -CP
MAIN-P.W.Board			R332	06S55366Y09	RES,RK 623J 1/10 -CP
MAIN-P.W.Board			R333	06S55366Y09	RES,RK 623J 1/10 -CP
MAIN-P.W.Board			R334	06S64995F37	RES,RK 221J 1/8 -CP
MAIN-P.W.Board			R335	06S64995F37	RES,RK 221J 1/8 -CP
MAIN-P.W.Board			R336	06S64995F37	RES,RK 221J 1/8 -CP
MAIN-P.W.Board			R337	06S64995F37	RES,RK 221J 1/8 -CP
MAIN-P.W.Board			R338	06S64995F37	RES,RK 221J 1/8 -CP
MAIN-P.W.Board			R339	06S64995F37	RES,RK 221J 1/8 -CP
MAIN-P.W.Board			R340	06S64995F29	RES,RK 101J 1/8 -CP
MAIN-P.W.Board			R341	06S64995F29	RES,RK 101J 1/8 -CP

Mark Model Code

#1 CDA-9884 Only,

\$1 CDA-9884E (General Foreign) Only,

%1 CDA-9884E (Chinese) Only,

&1 CDA-9884Li Only,

Others:Common.

NOTE:The part that has not PART NUMBER will not be supplied.

P.W.Board	MIS	MODEL	Ref.	Parts No.	Parts Name
MAIN-P.W.Board			R342	06S64995F29	RES,RK 101J 1/8 -CP
MAIN-P.W.Board			R343	06S64995F29	RES,RK 101J 1/8 -CP
MAIN-P.W.Board			R344	06S64995F29	RES,RK 101J 1/8 -CP
MAIN-P.W.Board			R345	06S64995F29	RES,RK 101J 1/8 -CP
MAIN-P.W.Board			R346	06S55366Y39	RES,RK JUMPER1/10-CP
MAIN-P.W.Board			R347	06S55366Y39	RES,RK JUMPER1/10-CP
MAIN-P.W.Board			R348	06S55366Y39	RES,RK JUMPER1/10-CP
MAIN-P.W.Board			R349	06S55366Y39	RES,RK JUMPER1/10-CP
MAIN-P.W.Board			R350	06S55366Y39	RES,RK JUMPER1/10-CP
MAIN-P.W.Board			R351	06S55366Y39	RES,RK JUMPER1/10-CP
MAIN-P.W.Board			R5002	06S15594Y09	RES,RK 304F 1/10 -CP
MAIN-P.W.Board			R5003	06S15594Y07	RES,RK 244F 1/10 -CP
MAIN-P.W.Board			R5005	06S55361Y65	RES,RK 102J 1/4 -CP
MAIN-P.W.Board			R5006	06S55361Y65	RES,RK 102J 1/4 -CP
MAIN-P.W.Board			R5007	06S55361Y65	RES,RK 102J 1/4 -CP
MAIN-P.W.Board			R5008	06S55366Y06	RES,RK 473J 1/10 -CP
MAIN-P.W.Board			R5009	06S55366Y06	RES,RK 473J 1/10 -CP
MAIN-P.W.Board			R501	06S45674W81	RES,RK 103J 1/10 -CP
MAIN-P.W.Board			R5010	06S15594Y12	RES,RK 394F 1/10 -CP
MAIN-P.W.Board			R5011	06S15593Y85	RES,RK 333F 1/10 -CP
MAIN-P.W.Board			R5014	06S55366Y06	RES,RK 473J 1/10 -CP
MAIN-P.W.Board			R5015	06S55366Y06	RES,RK 473J 1/10 -CP
MAIN-P.W.Board			R5018	06S55361Y65	RES,RK 102J 1/4 -CP
MAIN-P.W.Board			R5019	06S55361Y65	RES,RK 102J 1/4 -CP
MAIN-P.W.Board			R502	06S45674W81	RES,RK 103J 1/10 -CP
MAIN-P.W.Board			R5020	06S55361Y65	RES,RK 102J 1/4 -CP
MAIN-P.W.Board			R503	06S45674W97	RES,RK 473J 1/10 -CP
MAIN-P.W.Board			R504	06S15593Y77	RES,RK 153F 1/10 -CP
MAIN-P.W.Board			R505	06S45674W97	RES,RK 473J 1/10 -CP
MAIN-P.W.Board			R508	06S45674W75	RES,RK 562J 1/10 -CP
MAIN-P.W.Board			R509	06S45674W57	RES,RK 102J 1/10 -CP
MAIN-P.W.Board			R510	06S45674W57	RES,RK 102J 1/10 -CP
MAIN-P.W.Board			R512	06S45674W33	RES,RK 101J 1/10 -CP
MAIN-P.W.Board			R513	06S64995F53	RES,RK 102J 1/8 -CP
MAIN-P.W.Board			R514	06S45674W57	RES,RK 102J 1/10 -CP
MAIN-P.W.Board			R515	06S55366Y14	RES,RK 104J 1/10 -CP
MAIN-P.W.Board			R516	06S45675W22	RES,RK 474J 1/10 -CP
MAIN-P.W.Board			R518	06S45674W89	RES,RK 223J 1/10 -CP
MAIN-P.W.Board			R519	06S45674W81	RES,RK 103J 1/10 -CP

Mark Model Code

#1 CDA-9884 Only,

\$1 CDA-9884E (General Foreign) Only,

%1 CDA-9884E (Chinese) Only,

&1 CDA-9884Li Only,

Others:Common.

NOTE:The part that has not PART NUMBER will not be supplied.

P.W.Board	MIS	MODEL	Ref.	Parts No.	Parts Name
MAIN-P.W.Board			R521	06S45674W97	RES,RK 473J 1/10 -CP
MAIN-P.W.Board			R522	06S45674W57	RES,RK 102J 1/10 -CP
MAIN-P.W.Board			R523	06S45674W97	RES,RK 473J 1/10 -CP
MAIN-P.W.Board			R524	06S45674W89	RES,RK 223J 1/10 -CP
MAIN-P.W.Board			R525	06S64995F53	RES,RK 102J 1/8 -CP
MAIN-P.W.Board			R526	06S45674W89	RES,RK 223J 1/10 -CP
MAIN-P.W.Board			R527	06S45674W89	RES,RK 223J 1/10 -CP
MAIN-P.W.Board			R528	06S45674W33	RES,RK 101J 1/10 -CP
MAIN-P.W.Board			R529	06S45674W33	RES,RK 101J 1/10 -CP
MAIN-P.W.Board			R530	06S45674W57	RES,RK 102J 1/10 -CP
MAIN-P.W.Board			R532	06S64995F53	RES,RK 102J 1/8 -CP
MAIN-P.W.Board			R533	06S45674W67	RES,RK 272J 1/10 -CP
MAIN-P.W.Board			R534	06S45674W81	RES,RK 103J 1/10 -CP
MAIN-P.W.Board			R535	06S15593Y83	RES,RK 273F 1/10 -CP
MAIN-P.W.Board			R536	06S64995F53	RES,RK 102J 1/8 -CP
MAIN-P.W.Board			R537	06S45674W57	RES,RK 102J 1/10 -CP
MAIN-P.W.Board			R538	06S15593Y63	RES,RK 392F 1/10 -CP
MAIN-P.W.Board			R539	06S64995F53	RES,RK 102J 1/8 -CP
MAIN-P.W.Board			R540	06S64995F53	RES,RK 102J 1/8 -CP
MAIN-P.W.Board			R541	06S64995F53	RES,RK 102J 1/8 -CP
MAIN-P.W.Board			R542	06S64995F53	RES,RK 102J 1/8 -CP
MAIN-P.W.Board			R543	06S64995F53	RES,RK 102J 1/8 -CP
MAIN-P.W.Board			R544	06S64995F53	RES,RK 102J 1/8 -CP
MAIN-P.W.Board			R545	06S64995F53	RES,RK 102J 1/8 -CP
MAIN-P.W.Board			R546	06S64995F53	RES,RK 102J 1/8 -CP
MAIN-P.W.Board			R547	06S55365Y97	RES,RK 223J 1/10 -CP
MAIN-P.W.Board			R548	06S55363Y97	RES,RK 223J 1/8 -CP
MAIN-P.W.Board			R551	06S45674W57	RES,RK 102J 1/10 -CP
MAIN-P.W.Board			R552	06S45674W89	RES,RK 223J 1/10 -CP
MAIN-P.W.Board			R553	06S45674W77	RES,RK 682J 1/10 -CP
MAIN-P.W.Board			R554	06S45674W81	RES,RK 103J 1/10 -CP
MAIN-P.W.Board			R555	06S45674W81	RES,RK 103J 1/10 -CP
MAIN-P.W.Board			R556	06S45674W73	RES,RK 472J 1/10 -CP
MAIN-P.W.Board			R557	06S45674W77	RES,RK 682J 1/10 -CP
MAIN-P.W.Board			R558	06S45674W59	RES,RK 122J 1/10 -CP
MAIN-P.W.Board			R559	06S45674W81	RES,RK 103J 1/10 -CP
MAIN-P.W.Board			R560	06S45674W81	RES,RK 103J 1/10 -CP
MAIN-P.W.Board			R561	06S70072F19	RES,CP .39R-J-1/4-CP
MAIN-P.W.Board			R562	06S70072F19	RES,CP .39R-J-1/4-CP

Mark Model Code

#1 CDA-9884 Only,

\$1 CDA-9884E (General Foreign) Only,

%1 CDA-9884E (Chinese) Only,

&1 CDA-9884Li Only,

Others:Common.

NOTE:The part that has not PART NUMBER will not be supplied.

P.W.Board	MIS	MODEL	Ref.	Parts No.	Parts Name
MAIN-P.W.Board			R563	06S70072F19	RES,CP .39R-J-1/4-CP
MAIN-P.W.Board			R564	06S70072F05	RES,CP .10R-J-1/4-CP
MAIN-P.W.Board			R565	06S70072F19	RES,CP .39R-J-1/4-CP
MAIN-P.W.Board			R566	06S45674W65	RES,RK 222J 1/10 -CP
MAIN-P.W.Board			R567	06S45674W61	RES,RK 152J 1/10 -CP
MAIN-P.W.Board			R568	06S45674W61	RES,RK 152J 1/10 -CP
MAIN-P.W.Board			R569	06S45674W65	RES,RK 222J 1/10 -CP
MAIN-P.W.Board			R575	06S55363Y89	RES,RK 103J 1/8 -CP
MAIN-P.W.Board			R576	06S55366Y39	RES,RK JUMPER1/10-CP
MAIN-P.W.Board			R577	06S55366Y39	RES,RK JUMPER1/10-CP
MAIN-P.W.Board			R578	06S45674W57	RES,RK 102J 1/10 -CP
MAIN-P.W.Board			R579	06S45674W57	RES,RK 102J 1/10 -CP
MAIN-P.W.Board			R580	06S45674W33	RES,RK 101J 1/10 -CP
MAIN-P.W.Board			R581	06S45674W33	RES,RK 101J 1/10 -CP
MAIN-P.W.Board			R582	06S45674W75	RES,RK 562J 1/10 -CP
MAIN-P.W.Board			R583	06S45674W97	RES,RK 473J 1/10 -CP
MAIN-P.W.Board			R584	06S55366Y39	RES,RK JUMPER1/10-CP
MAIN-P.W.Board			R585	06S55366Y39	RES,RK JUMPER1/10-CP
MAIN-P.W.Board			R586	06S55366Y39	RES,RK JUMPER1/10-CP
MAIN-P.W.Board			R597	06S45674W97	RES,RK 473J 1/10 -CP
MAIN-P.W.Board			R601	06S55364Y39	RES,RK JUMPER 1/8-CP
MAIN-P.W.Board			R603	06S45674W97	RES,RK 473J 1/10 -CP
MAIN-P.W.Board			R604	06S70072F77	RES,CP .103-J-1/4-CP
MAIN-P.W.Board			R605	06S45674W81	RES,RK 103J 1/10 -CP
MAIN-P.W.Board			R606	06S70072F77	RES,CP .103-J-1/4-CP
MAIN-P.W.Board			R619	06S55366Y14	RES,RK 104J 1/10 -CP
MAIN-P.W.Board			R620	06S55361Y62	RES,RK 751J 1/4 -CP
MAIN-P.W.Board			R641	06S45675W22	RES,RK 474J 1/10 -CP
MAIN-P.W.Board			R642	06S45674W89	RES,RK 223J 1/10 -CP
MAIN-P.W.Board			R643	06S70072F29	RES,CP .101-J-1/4-CP
MAIN-P.W.Board			R644	06S45674W65	RES,RK 222J 1/10 -CP
MAIN-P.W.Board			R645	06S45674W69	RES,RK 332J 1/10 -CP
MAIN-P.W.Board			R646	06S45674W89	RES,RK 223J 1/10 -CP
MAIN-P.W.Board			R647	06S45674W57	RES,RK 102J 1/10 -CP
MAIN-P.W.Board			R703	06S55364Y39	RES,RK JUMPER 1/8-CP
MAIN-P.W.Board			R705	06S55364Y39	RES,RK JUMPER 1/8-CP
MAIN-P.W.Board			R708	06S55365Y66	RES,RK 112J 1/10 -CP
MAIN-P.W.Board			R709	06S55365Y66	RES,RK 112J 1/10 -CP
MAIN-P.W.Board			R710	06S55365Y66	RES,RK 112J 1/10 -CP

Mark Model Code

#1 CDA-9884 Only,

\$1 CDA-9884E (General Foreign) Only,

%1 CDA-9884E (Chinese) Only,

&1 CDA-9884Li Only,

Others:Common.

NOTE:The part that has not PART NUMBER will not be supplied.

P.W.Board	MIS	MODEL	Ref.	Parts No.	Parts Name
MAIN-P.W.Board			R711	06S55365Y66	RES,RK 112J 1/10 -CP
MAIN-P.W.Board			R712	06S15593Y69	RES,RK 682F 1/10 -CP
MAIN-P.W.Board			R713	06S15593Y69	RES,RK 682F 1/10 -CP
MAIN-P.W.Board			R714	06S55366Y39	RES,RK JUMPER1/10-CP
MAIN-P.W.Board			R715	06S55366Y39	RES,RK JUMPER1/10-CP
MAIN-P.W.Board			R717	06S15593Y81	RES,RK 223F 1/10 -CP
MAIN-P.W.Board			R718	06S15593Y81	RES,RK 223F 1/10 -CP
MAIN-P.W.Board			R719	06S15593Y81	RES,RK 223F 1/10 -CP
MAIN-P.W.Board			R720	06S15593Y81	RES,RK 223F 1/10 -CP
MAIN-P.W.Board			R721	06S15593Y81	RES,RK 223F 1/10 -CP
MAIN-P.W.Board			R722	06S15593Y81	RES,RK 223F 1/10 -CP
MAIN-P.W.Board			R723	06S15593Y81	RES,RK 223F 1/10 -CP
MAIN-P.W.Board			R724	06S15593Y81	RES,RK 223F 1/10 -CP
MAIN-P.W.Board			R725	06S15593Y81	RES,RK 223F 1/10 -CP
MAIN-P.W.Board			R726	06S15593Y81	RES,RK 223F 1/10 -CP
MAIN-P.W.Board			R727	06S15593Y81	RES,RK 223F 1/10 -CP
MAIN-P.W.Board			R728	06S15593Y81	RES,RK 223F 1/10 -CP
MAIN-P.W.Board			R729	06S15593Y81	RES,RK 223F 1/10 -CP
MAIN-P.W.Board			R730	06S15593Y81	RES,RK 223F 1/10 -CP
MAIN-P.W.Board			R731	06S15593Y81	RES,RK 223F 1/10 -CP
MAIN-P.W.Board			R732	06S15593Y81	RES,RK 223F 1/10 -CP
MAIN-P.W.Board		\$1	R751	06S55366Y39	RES,RK JUMPER1/10-CP
MAIN-P.W.Board		%1	R751	06S55366Y39	RES,RK JUMPER1/10-CP
MAIN-P.W.Board		\$1	R752	06S55366Y39	RES,RK JUMPER1/10-CP
MAIN-P.W.Board		%1	R752	06S55366Y39	RES,RK JUMPER1/10-CP
MAIN-P.W.Board			R753	06S45674W97	RES,RK 473J 1/10 -CP
MAIN-P.W.Board		\$1	R800	06S55361Y47	RES,RK 181J 1/4 -CP
MAIN-P.W.Board		%1	R800	06S55361Y47	RES,RK 181J 1/4 -CP
MAIN-P.W.Board			R801	06S70072F77	RES,CP .103-J-1/4-CP
MAIN-P.W.Board			R802	06S55365Y78	RES,RK 362J 1/10 -CP
MAIN-P.W.Board			R803	06S55365Y78	RES,RK 362J 1/10 -CP
MAIN-P.W.Board			R804	06S45674W65	RES,RK 222J 1/10 -CP
MAIN-P.W.Board			R805	06S45674W81	RES,RK 103J 1/10 -CP
MAIN-P.W.Board			R806	06S35095Y16	RES,RK 303J 1/4 -CP
MAIN-P.W.Board			R807	06S55361Y74	RES,RK 242J 1/4 -CP
MAIN-P.W.Board			R808	06S55361Y82	RES,RK 512J 1/4 -CP
MAIN-P.W.Board			R809	06S55361Y70	RES,RK 162J 1/4 -CP
MAIN-P.W.Board			R811	06S55361Y70	RES,RK 162J 1/4 -CP
MAIN-P.W.Board			R812	06S55361Y70	RES,RK 162J 1/4 -CP

Mark Model Code

#1 CDA-9884 Only,

\$1 CDA-9884E (General Foreign) Only,

%1 CDA-9884E (Chinese) Only,

&1 CDA-9884Li Only,

Others:Common.

NOTE:The part that has not PART NUMBER will not be supplied.

P.W.Board	MIS	MODEL	Ref.	Parts No.	Parts Name
MAIN-P.W.Board			R813	06S35083Y42	RES,RK 273F 1/4 -CP
MAIN-P.W.Board			R814	06S55361Y01	RES,RK 2R2J 1/4 -CP
MAIN-P.W.Board			R815	06S55361Y70	RES,RK 162J 1/4 -CP
MAIN-P.W.Board			R816	06S35083Y45	RES,RK 473F 1/4 -CP
MAIN-P.W.Board			R818	06S55365Y98	RES,RK 243J 1/10 -CP
MAIN-P.W.Board			R819	06S55361Y70	RES,RK 162J 1/4 -CP
MAIN-P.W.Board			R820	06S55361Y01	RES,RK 2R2J 1/4 -CP
MAIN-P.W.Board		\$1	R821	06S55361Y47	RES,RK 181J 1/4 -CP
MAIN-P.W.Board		%1	R821	06S55361Y47	RES,RK 181J 1/4 -CP
MAIN-P.W.Board		\$1	R822	06S55361Y47	RES,RK 181J 1/4 -CP
MAIN-P.W.Board		%1	R822	06S55361Y47	RES,RK 181J 1/4 -CP
MAIN-P.W.Board			R823	06S70072F39	RES,CP .271-J-1/4-CP
MAIN-P.W.Board			R824	06S70072F39	RES,CP .271-J-1/4-CP
MAIN-P.W.Board		\$1	R825	06S15593Y90	RES,RK 513F 1/10 -CP
MAIN-P.W.Board		%1	R825	06S15593Y90	RES,RK 513F 1/10 -CP
MAIN-P.W.Board		\$1	R826	06S15593Y76	RES,RK 133F 1/10 -CP
MAIN-P.W.Board		%1	R826	06S15593Y76	RES,RK 133F 1/10 -CP
MAIN-P.W.Board		\$1	R827	06S15594Y10	RES,RK 334F 1/10 -CP
MAIN-P.W.Board		%1	R827	06S15594Y10	RES,RK 334F 1/10 -CP
MAIN-P.W.Board		\$1	R829	06S15593Y49	RES,RK 102F 1/10 -CP
MAIN-P.W.Board		%1	R829	06S15593Y49	RES,RK 102F 1/10 -CP
MAIN-P.W.Board		\$1	R830	06S15593Y57	RES,RK 222F 1/10 -CP
MAIN-P.W.Board		%1	R830	06S15593Y57	RES,RK 222F 1/10 -CP
MAIN-P.W.Board		\$1	R831	06S15593Y96	RES,RK 913F 1/10 -CP
MAIN-P.W.Board		%1	R831	06S15593Y96	RES,RK 913F 1/10 -CP
MAIN-P.W.Board		\$1	R832	06S15593Y93	RES,RK 683F 1/10 -CP
MAIN-P.W.Board		%1	R832	06S15593Y93	RES,RK 683F 1/10 -CP
MAIN-P.W.Board		\$1	R833	06S15593Y89	RES,RK 473F 1/10 -CP
MAIN-P.W.Board		%1	R833	06S15593Y89	RES,RK 473F 1/10 -CP
MAIN-P.W.Board		\$1	R835	06S55361Y65	RES,RK 102J 1/4 -CP
MAIN-P.W.Board		%1	R835	06S55361Y65	RES,RK 102J 1/4 -CP
MAIN-P.W.Board		\$1	R837	06S55365Y29	RES,RK 33RJ 1/10 -CP
MAIN-P.W.Board		%1	R837	06S55365Y29	RES,RK 33RJ 1/10 -CP
MAIN-P.W.Board			R842	06S55366Y14	RES,RK 104J 1/10 -CP
MAIN-P.W.Board			R843	06S55366Y14	RES,RK 104J 1/10 -CP
MAIN-P.W.Board			R844	06S55361Y51	RES,RK 271J 1/4 -CP
MAIN-P.W.Board			RA501	06S45591W07	RES,ARY MNR101J 4-CP
MAIN-P.W.Board			SA001	48-00954Z01	VST,CSA30C201M-T -CP
MAIN-P.W.Board		\$1	SD800	48T45286Y01	DIO,SHT RB050L-40-E1

Mark Model Code

#1 CDA-9884 Only,



\$1 CDA-9884E (General Foreign) Only,

%1 CDA-9884E (Chinese) Only,

&1 CDA-9884Li Only,

Others:Common.

NOTE:The part that has not PART NUMBER will not be supplied.

P.W.Board	MIS	MODEL	Ref.	Parts No.	Parts Name
MAIN-P.W.Board		%1	SD800	48T45286Y01	DIO,SHT RB050L-40-E1
MAIN-P.W.Board			SW501	40T16096W03	SW ,TACT SKHHLW
MAIN-P.W.Board			SW700	40T45282W02	SW,SLIDE SLD-42-508X
MAIN-P.W.Board			SW701	40T15452Y01	SW,SLIDE SLD-62-724X
MAIN-P.W.Board			SW702	40T45282W02	SW,SLIDE SLD-42-508X
MAIN-P.W.Board			TU001	TU-04070Z04	TUNER,TFTEIU113C
MAIN-P.W.Board		\$1	VR800	18T25572Y19	VAR,RH03ADC 104-X-CP
MAIN-P.W.Board		%1	VR800	18T25572Y19	VAR,RH03ADC 104-X-CP
MAIN-P.W.Board			XL501	91T15849W02	XTAL,32.768KHZ
MAIN-P.W.Board			XL502	91T55360Y06	XTL,6M-AT51-TP
MAIN-P.W.Board			Z502	91T65112W06	EMI,BK2125HM102 -CP
MAIN-P.W.Board			ZD5000	48-11191Z09	DIO,ZEN MAZ8036GL-CP
MAIN-P.W.Board			ZD5001	48-11191Z09	DIO,ZEN MAZ8036GL-CP
MAIN-P.W.Board			ZD602	48T25766W27	DIO,ZEN.HZS11A1L -R5
MAIN-P.W.Board		\$1	ZD800	48T15541Y10	DIO,ZEN MAZS056 -CP
MAIN-P.W.Board		%1	ZD800	48T15541Y10	DIO,ZEN MAZS056 -CP
MAIN-P.W.Board			ZD801	48T25766W09	DIO,ZEN.HZS 6C3L -R5
MAIN-P.W.Board			ZD802	48-02592Z01	DIO,ZEN Z5W27VJ -EA
MAIN-P.W.Board		\$1	ZD803	48T15541Y10	DIO,ZEN MAZS056 -CP
MAIN-P.W.Board		%1	ZD803	48T15541Y10	DIO,ZEN MAZS056 -CP
MAIN-P.W.Board			ZD804	48T25766W38	DIO,ZEN.HZS12A3L -R5
FRONT-P.W.Board			C400	08T81833F07	CAP,CER 105K-B1C -CP
FRONT-P.W.Board			C401	08S35349Y05	CAP,CER 681K-B1H -CP
FRONT-P.W.Board			C402	08S45677W60	CAP,CER 102J-CH1H-CP
FRONT-P.W.Board			C403	08S45676W89	CAP,CER 473K-B1E -CP
FRONT-P.W.Board			C404	08S45676W89	CAP,CER 473K-B1E -CP
FRONT-P.W.Board			C405	08S45676W80	CAP,CER 223K-B1E -CP
FRONT-P.W.Board			C406	08S45676W89	CAP,CER 473K-B1E -CP
FRONT-P.W.Board			C407	08S45676W89	CAP,CER 473K-B1E -CP
FRONT-P.W.Board			C408	08S45676W89	CAP,CER 473K-B1E -CP
FRONT-P.W.Board			C409	08S45676W80	CAP,CER 223K-B1E -CP
FRONT-P.W.Board			C411	08S65676Y02	CAP,CER 475KX7R1A-CP
FRONT-P.W.Board			C412	08S45676W80	CAP,CER 223K-B1E -CP
FRONT-P.W.Board			C413	08S45676W85	CAP,CER 104K-B1C -CP
FRONT-P.W.Board			C414	08T81833F11	CAP,CER 225K-B1C -CP
FRONT-P.W.Board			C415	08S45676W85	CAP,CER 104K-B1C -CP
FRONT-P.W.Board			C416	08S35374W11	CAP,CER 475K-B0J -CP
FRONT-P.W.Board			C420	08S45676W80	CAP,CER 223K-B1E -CP
FRONT-P.W.Board			CB401	09-04216Z01	BTB,DH16-P -B

Mark Model Code

#1 CDA-9884 Only,

\$1 CDA-9884E (General Foreign) Only,

%1 CDA-9884E (Chinese) Only,

&1 CDA-9884Li Only,

Others:Common.

NOTE:The part that has not PART NUMBER will not be supplied.

P.W.Board	MIS	MODEL	Ref.	Parts No.	Parts Name
FRONT-P.W.Board			D401	48T81063F01	DIO,CP.MA159 / TX-CP
FRONT-P.W.Board			D403	48T81063F01	DIO,CP.MA159 / TX-CP
FRONT-P.W.Board			D406	48T81063F01	DIO,CP.MA159 / TX-CP
FRONT-P.W.Board			D407	48T94471F04	DIO,IMN10-T108 -CP
FRONT-P.W.Board			D408	48T85357W01	DIO,1PS226 -CP
FRONT-P.W.Board			D409	48-06707Z01	DIO,MA3J147-TX -CP
FRONT-P.W.Board			D410	48-06707Z01	DIO,MA3J147-TX -CP
FRONT-P.W.Board			D411	48-06707Z01	DIO,MA3J147-TX -CP
FRONT-P.W.Board			D412	48-06707Z01	DIO,MA3J147-TX -CP
FRONT-P.W.Board			D413	48-06707Z01	DIO,MA3J147-TX -CP
FRONT-P.W.Board			D414	48-06707Z01	DIO,MA3J147-TX -CP
FRONT-P.W.Board			D415	48-08551Z02	LED,ARY QB.L.031 -DB
FRONT-P.W.Board			D416	48-11191Z23	DIO,ZEN MAZ8056GM-CP
FRONT-P.W.Board			D417	48-06706Z01	DIO,MA2J111-TX -CP
FRONT-P.W.Board			D418	48-06706Z01	DIO,MA2J111-TX -CP
FRONT-P.W.Board			D419	48-06706Z01	DIO,MA2J111-TX -CP
FRONT-P.W.Board			IC401	51-11746Z01	LC75878W-UALP-E -QT
FRONT-P.W.Board			IC402	51-11888Z01	LC75857WH-UALP-E -QT
FRONT-P.W.Board			IC404	51-11731Z01	RPMS2381-H19-E4A-NE5
FRONT-P.W.Board			LCD401	65-10797Z01	LCD,TB2115BMM0TTN-F
FRONT-P.W.Board			LD407	48-11414Z01	LED,RED KPT-1608S-CP
FRONT-P.W.Board			LD408	48-11414Z01	LED,RED KPT-1608S-CP
FRONT-P.W.Board			LD409	48-11414Z01	LED,RED KPT-1608S-CP
FRONT-P.W.Board			LD410	48-11414Z01	LED,RED KPT-1608S-CP
FRONT-P.W.Board			LD411	48-11414Z01	LED,RED KPT-1608S-CP
FRONT-P.W.Board			LD412	48-11414Z01	LED,RED KPT-1608S-CP
FRONT-P.W.Board			LD413	48-05731Z01	LED,BLU SML012BCT-CP
FRONT-P.W.Board			LD414	48-05731Z01	LED,BLU SML012BCT-CP
FRONT-P.W.Board			LD417	48-11414Z01	LED,RED KPT-1608S-CP
FRONT-P.W.Board			LD418	48-11414Z01	LED,RED KPT-1608S-CP
FRONT-P.W.Board			LD419	48-11414Z01	LED,RED KPT-1608S-CP
FRONT-P.W.Board			LD420	48-11414Z01	LED,RED KPT-1608S-CP
FRONT-P.W.Board			LD421	48-11414Z01	LED,RED KPT-1608S-CP
FRONT-P.W.Board			LD422	48-11414Z01	LED,RED KPT-1608S-CP
FRONT-P.W.Board			LD423	48-11414Z01	LED,RED KPT-1608S-CP
FRONT-P.W.Board			LD424	48-11414Z01	LED,RED KPT-1608S-CP
FRONT-P.W.Board			LD425	48-11414Z01	LED,RED KPT-1608S-CP
FRONT-P.W.Board			LD426	48-11414Z01	LED,RED KPT-1608S-CP
FRONT-P.W.Board			LD427	48-11414Z01	LED,RED KPT-1608S-CP

Mark Model Code

#1 CDA-9884 Only,

\$1 CDA-9884E (General Foreign) Only,

%1 CDA-9884E (Chinese) Only,

&1 CDA-9884Li Only,

Others:Common.

NOTE:The part that has not PART NUMBER will not be supplied.

P.W.Board	MIS	MODEL	Ref.	Parts No.	Parts Name
FRONT-P.W.Board			LD428	48-11414Z01	LED,RED KPT-1608S-CP
FRONT-P.W.Board			LD429	48-11414Z01	LED,RED KPT-1608S-CP
FRONT-P.W.Board			LD430	48-11414Z01	LED,RED KPT-1608S-CP
FRONT-P.W.Board			LD431	48-11414Z01	LED,RED KPT-1608S-CP
FRONT-P.W.Board			LD432	48-11414Z01	LED,RED KPT-1608S-CP
FRONT-P.W.Board			LD433	48-11414Z01	LED,RED KPT-1608S-CP
FRONT-P.W.Board			LD434	48-11414Z01	LED,RED KPT-1608S-CP
FRONT-P.W.Board			LD435	48-11414Z01	LED,RED KPT-1608S-CP
FRONT-P.W.Board			LD436	48-11414Z01	LED,RED KPT-1608S-CP
FRONT-P.W.Board			LD437	48-11414Z01	LED,RED KPT-1608S-CP
FRONT-P.W.Board			LD459	48-11416Z01	LED,BLU SSB-ULD -CP
FRONT-P.W.Board			LD461	48-11414Z01	LED,RED KPT-1608S-CP
FRONT-P.W.Board			Q402	48T63788F04	TR,2SD1328-T-TX -CP
FRONT-P.W.Board			Q404	48T64222F04	TR,UN2214 10-47-TXCP
FRONT-P.W.Board			Q405	48T64222F04	TR,UN2214 10-47-TXCP
FRONT-P.W.Board			Q406	48T64222F04	TR,UN2214 10-47-TXCP
FRONT-P.W.Board			Q408	48T52438F04	TR ,2SD601A-S /TX-CP
FRONT-P.W.Board			Q409	48T52438F04	TR ,2SD601A-S /TX-CP
FRONT-P.W.Board			Q411	48T45594W16	TR,XN1A311-TX -CP
FRONT-P.W.Board			Q412	48T45594W12	TR ,XN1A312 -TX-CP
FRONT-P.W.Board			R400	06S45674W57	RES,RK 102J 1/10 -CP
FRONT-P.W.Board			R406	06S45674W57	RES,RK 102J 1/10 -CP
FRONT-P.W.Board			R409	06S55361Y65	RES,RK 102J 1/4 -CP
FRONT-P.W.Board			R410	06S70072F51	RES,CP .821-J-1/4-CP
FRONT-P.W.Board			R411	06S70072F51	RES,CP .821-J-1/4-CP
FRONT-P.W.Board			R412	06S70072F51	RES,CP .821-J-1/4-CP
FRONT-P.W.Board			R413	06S70072F61	RES,CP .222-J-1/4-CP
FRONT-P.W.Board			R418	06S45674W61	RES,RK 152J 1/10 -CP
FRONT-P.W.Board			R419	06S70072F59	RES,CP .182-J-1/4-CP
FRONT-P.W.Board			R420	06S70072F59	RES,CP .182-J-1/4-CP
FRONT-P.W.Board			R421	06S45674W73	RES,RK 472J 1/10 -CP
FRONT-P.W.Board			R422	06S45675W43	RES,RK JUMPER1/10-CP
FRONT-P.W.Board			R423	06S70072F55	RES,CP .122-J-1/4-CP
FRONT-P.W.Board			R424	06S70072F58	RES,CF .162-J-1/4-CP
FRONT-P.W.Board			R425	06S70072F77	RES,CP .103-J-1/4-CP
FRONT-P.W.Board			R426	06S55366Y06	RES,RK 473J 1/10 -CP
FRONT-P.W.Board			R427	06S64995F53	RES,RK 102J 1/8 -CP
FRONT-P.W.Board			R428	06S45674W73	RES,RK 472J 1/10 -CP
FRONT-P.W.Board			R429	06S55361Y45	RES,RK 151J 1/4 -CP

Mark Model Code

#1 CDA-9884 Only,

\$1 CDA-9884E (General Foreign) Only,

%1 CDA-9884E (Chinese) Only,

&1 CDA-9884Li Only,

Others:Common.

NOTE:The part that has not PART NUMBER will not be supplied.

P.W.Board	MIS	MODEL	Ref.	Parts No.	Parts Name
FRONT-P.W.Board			R440	06S55366Y05	RES,RK 433J 1/10 -CP
FRONT-P.W.Board			R441	06S45674W73	RES,RK 472J 1/10 -CP
FRONT-P.W.Board			R442	06S45674W73	RES,RK 472J 1/10 -CP
FRONT-P.W.Board			R443	06S45674W73	RES,RK 472J 1/10 -CP
FRONT-P.W.Board			R445	06S45674W93	RES,RK 333J 1/10 -CP
FRONT-P.W.Board			R446	06S45674W73	RES,RK 472J 1/10 -CP
FRONT-P.W.Board			R447	06S45674W73	RES,RK 472J 1/10 -CP
FRONT-P.W.Board			R448	06S45674W73	RES,RK 472J 1/10 -CP
FRONT-P.W.Board			R449	06S45674W73	RES,RK 472J 1/10 -CP
FRONT-P.W.Board			R451	06S64995F53	RES,RK 102J 1/8 -CP
FRONT-P.W.Board			R452	06S64995F53	RES,RK 102J 1/8 -CP
FRONT-P.W.Board			R453	06S55361Y53	RES,RK 331J 1/4 -CP
FRONT-P.W.Board			R454	06S15593Y49	RES,RK 102F 1/10 -CP
FRONT-P.W.Board			R457	06S55362Y14	RES,RK 104J 1/4 -CP
FRONT-P.W.Board			R458	06S55361Y56	RES,RK 431J 1/4 -CP
FRONT-P.W.Board			R459	06S64995F53	RES,RK 102J 1/8 -CP
FRONT-P.W.Board			R460	06S64995F53	RES,RK 102J 1/8 -CP
FRONT-P.W.Board			R461	06S15593Y25	RES,RK 101F 1/10 -CP
FRONT-P.W.Board			R462	06S64995F53	RES,RK 102J 1/8 -CP
FRONT-P.W.Board			R463	06S64995F53	RES,RK 102J 1/8 -CP
FRONT-P.W.Board			R464	06S64995F53	RES,RK 102J 1/8 -CP
FRONT-P.W.Board			R465	06S64995F53	RES,RK 102J 1/8 -CP
FRONT-P.W.Board			R468	06S55365Y73	RES,RK 222J 1/10 -CP
FRONT-P.W.Board			R470	06S55361Y57	RES,RK 471J 1/4 -CP
FRONT-P.W.Board			R471	06S45675W43	RES,RK JUMPER1/10-CP
FRONT-P.W.Board			R473	06S45674W97	RES,RK 473J 1/10 -CP
FRONT-P.W.Board			R474	06S45674W97	RES,RK 473J 1/10 -CP
FRONT-P.W.Board			R475	06S45674W97	RES,RK 473J 1/10 -CP
FRONT-P.W.Board			R476	06S45674W97	RES,RK 473J 1/10 -CP
FRONT-P.W.Board			R477	06S15593Y49	RES,RK 102F 1/10 -CP
FRONT-P.W.Board			R478	06S45674W97	RES,RK 473J 1/10 -CP
FRONT-P.W.Board			R487	06S70072F58	RES,CF .162-J-1/4-CP
FRONT-P.W.Board			R489	06S55361Y77	RES,RK 332J 1/4 -CP
FRONT-P.W.Board			R491	06S70072F98	RES,RK 223J 1/4 -CP
FRONT-P.W.Board			R492	06S45674W57	RES,RK 102J 1/10 -CP
FRONT-P.W.Board			RA401	06S45591W06	RES,ARY MNR102J 4-CP
FRONT-P.W.Board			RA402	06S45591W06	RES,ARY MNR102J 4-CP
FRONT-P.W.Board			SW401	40T65353Y01	SW,TACT SKRSPACE010E2
FRONT-P.W.Board			SW402	40T65353Y01	SW,TACT SKRSPACE010E2

Mark Model Code

#1 CDA-9884 Only,

\$1 CDA-9884E (General Foreign) Only,

%1 CDA-9884E (Chinese) Only,

&1 CDA-9884Li Only,

Others:Common.

NOTE:The part that has not PART NUMBER will not be supplied.

P.W.Board	MIS	MODEL	Ref.	Parts No.	Parts Name
FRONT-P.W.Board			SW403	40T65353Y01	SW,TACT SKRSPACE010E2
FRONT-P.W.Board			SW404	40T65353Y01	SW,TACT SKRSPACE010E2
FRONT-P.W.Board			SW405	40T65353Y01	SW,TACT SKRSPACE010E2
FRONT-P.W.Board			SW406	40T65353Y01	SW,TACT SKRSPACE010E2
FRONT-P.W.Board			SW407	40T65353Y01	SW,TACT SKRSPACE010E2
FRONT-P.W.Board			SW408	40T65353Y01	SW,TACT SKRSPACE010E2
FRONT-P.W.Board			SW409	40T65353Y01	SW,TACT SKRSPACE010E2
FRONT-P.W.Board			SW410	40T65353Y01	SW,TACT SKRSPACE010E2
FRONT-P.W.Board			SW411	40T65353Y01	SW,TACT SKRSPACE010E2
FRONT-P.W.Board			SW412	40T65353Y01	SW,TACT SKRSPACE010E2
FRONT-P.W.Board			SW413	40T65353Y01	SW,TACT SKRSPACE010E2
FRONT-P.W.Board			SW414	40T65353Y01	SW,TACT SKRSPACE010E2
FRONT-P.W.Board			SW415	40T65353Y01	SW,TACT SKRSPACE010E2
FRONT-P.W.Board			SW416	40T65353Y01	SW,TACT SKRSPACE010E2
FRONT-P.W.Board			SW417	40T65353Y01	SW,TACT SKRSPACE010E2
FRONT-P.W.Board			SW418	40T65353Y01	SW,TACT SKRSPACE010E2
FRONT-P.W.Board			SW419	40T65353Y01	SW,TACT SKRSPACE010E2
FRONT-P.W.Board			SW420	40-10735Z01	ENC,EC12D1524401 -DB
FRONT-P.W.Board			SW421	40T65353Y01	SW,TACT SKRSPACE010E2
FRONT-P.W.Board			ZD401	48-07043Z22	DIO,ZEN KDZ5.1V-Y-CP
MECH-P.W.Board			C1010	08S45232Y13	CAP,CER 223K-B1C -CP
MECH-P.W.Board			C1013	08S45232Y08	CAP,CER 332K-B1H -CP
MECH-P.W.Board			C1016	08S35349Y17	CAP,CER 225K-B0J -CP
MECH-P.W.Board			C1017	08S45232Y05	CAP,CER 102K-B1H -CP
MECH-P.W.Board			C1104	08S45232Y17	CAP,CER 104K-B0J -CP
MECH-P.W.Board			C1105	08S45231Y21	CAP,CER 47RJ-CH1H-CP
MECH-P.W.Board			C1106	08S45231Y21	CAP,CER 47RJ-CH1H-CP
MECH-P.W.Board			C1107	08S45231Y21	CAP,CER 47RJ-CH1H-CP
MECH-P.W.Board			C1108	08S45231Y21	CAP,CER 47RJ-CH1H-CP
MECH-P.W.Board			C1109	08S45232Y17	CAP,CER 104K-B0J -CP
MECH-P.W.Board			C1116	08S45232Y17	CAP,CER 104K-B0J -CP
MECH-P.W.Board			C1117	08S45232Y17	CAP,CER 104K-B0J -CP
MECH-P.W.Board			C1119	08S45231Y23	CAP,CER 68RJ-CH1H-CP
MECH-P.W.Board			C1121	08S45232Y14	CAP,CER 333K-B1C -CP
MECH-P.W.Board			C1122	08S45232Y14	CAP,CER 333K-B1C -CP
MECH-P.W.Board			C1123	08S45232Y17	CAP,CER 104K-B0J -CP
MECH-P.W.Board			C1124	08S45232Y17	CAP,CER 104K-B0J -CP
MECH-P.W.Board			C1125	08S45231Y14	CAP,CER 12RJ-CH1H-CP
MECH-P.W.Board			C1126	08S45231Y15	CAP,CER 15RJ-CH1H-CP

Mark Model Code

#1 CDA-9884 Only,

\$1 CDA-9884E (General Foreign) Only,

%1 CDA-9884E (Chinese) Only,

&1 CDA-9884Li Only,

Others:Common.

NOTE:The part that has not PART NUMBER will not be supplied.

P.W.Board	MIS	MODEL	Ref.	Parts No.	Parts Name
MECH-P.W.Board			C1128	08S45232Y17	CAP,CER 104K-B0J -CP
MECH-P.W.Board			C1129	08S45232Y07	CAP,CER 222K-B1H -CP
MECH-P.W.Board			C1130	08S45232Y17	CAP,CER 104K-B0J -CP
MECH-P.W.Board			C1132	08S45232Y17	CAP,CER 104K-B0J -CP
MECH-P.W.Board			C1133	08S45232Y17	CAP,CER 104K-B0J -CP
MECH-P.W.Board			C1134	08S45232Y17	CAP,CER 104K-B0J -CP
MECH-P.W.Board			C1136	08S45232Y17	CAP,CER 104K-B0J -CP
MECH-P.W.Board			C1137	08S45232Y17	CAP,CER 104K-B0J -CP
MECH-P.W.Board			C1138	08S45232Y17	CAP,CER 104K-B0J -CP
MECH-P.W.Board			C1140	08S45232Y14	CAP,CER 333K-B1C -CP
MECH-P.W.Board			C1141	08S45232Y12	CAP,CER 153K-B1C -CP
MECH-P.W.Board			C1142	08S45231Y19	CAP,CER 33RJ-CH1H-CP
MECH-P.W.Board			C1143	08S45232Y17	CAP,CER 104K-B0J -CP
MECH-P.W.Board			C1144	08S45232Y11	CAP,CER 103K-B1C -CP
MECH-P.W.Board			C1145	08S45232Y11	CAP,CER 103K-B1C -CP
MECH-P.W.Board			C1146	08S45232Y10	CAP,CER 682K-B1E -CP
MECH-P.W.Board			C1147	08S45232Y11	CAP,CER 103K-B1C -CP
MECH-P.W.Board			C1148	08S45232Y17	CAP,CER 104K-B0J -CP
MECH-P.W.Board			C1149	08S45232Y12	CAP,CER 153K-B1C -CP
MECH-P.W.Board			C1150	08S45232Y05	CAP,CER 102K-B1H -CP
MECH-P.W.Board			C1151	08S45232Y17	CAP,CER 104K-B0J -CP
MECH-P.W.Board			C1152	08S45232Y05	CAP,CER 102K-B1H -CP
MECH-P.W.Board			C1153	08S45232Y17	CAP,CER 104K-B0J -CP
MECH-P.W.Board			C1154	08S45232Y17	CAP,CER 104K-B0J -CP
MECH-P.W.Board			C1156	08S35374W12	CAP,CER 106K-B0J -CP
MECH-P.W.Board			C1200	08S35374W12	CAP,CER 106K-B0J -CP
MECH-P.W.Board			C1201	08S45232Y17	CAP,CER 104K-B0J -CP
MECH-P.W.Board			C1202	08S45232Y05	CAP,CER 102K-B1H -CP
MECH-P.W.Board			C1203	08S65668Y05	CAP,CER 224KX5R1A-CP
MECH-P.W.Board			C1204	08S45232Y17	CAP,CER 104K-B0J -CP
MECH-P.W.Board			C1205	08S35374W12	CAP,CER 106K-B0J -CP
MECH-P.W.Board			C1206	08S35349Y17	CAP,CER 225K-B0J -CP
MECH-P.W.Board			C1207	08S45231Y17	CAP,CER 22RJ-CH1H-CP
MECH-P.W.Board			C1208	08S45231Y17	CAP,CER 22RJ-CH1H-CP
MECH-P.W.Board			C1209	08S45232Y17	CAP,CER 104K-B0J -CP
MECH-P.W.Board			C1210	08S45232Y17	CAP,CER 104K-B0J -CP
MECH-P.W.Board			C1211	08S45231Y14	CAP,CER 12RJ-CH1H-CP
MECH-P.W.Board			C1212	08S45231Y14	CAP,CER 12RJ-CH1H-CP
MECH-P.W.Board			C1213	08S65668Y05	CAP,CER 224KX5R1A-CP

Mark Model Code

#1 CDA-9884 Only,

\$1 CDA-9884E (General Foreign) Only,

%1 CDA-9884E (Chinese) Only,

&1 CDA-9884Li Only,

Others:Common.

NOTE:The part that has not PART NUMBER will not be supplied.

P.W.Board	MIS	MODEL	Ref.	Parts No.	Parts Name
MECH-P.W.Board			C1214	08S65668Y05	CAP,CER 224KX5R1A-CP
MECH-P.W.Board			C1215	08S45231Y25	CAP,CER 101J-CH1H-CP
MECH-P.W.Board			C1216	08S45676W80	CAP,CER 223K-B1E -CP
MECH-P.W.Board			C1217	08S65667Y01	CAP,CER 224KX5R1C-CP
MECH-P.W.Board			C1218	08S45232Y17	CAP,CER 104K-B0J -CP
MECH-P.W.Board			C1219	08S45231Y25	CAP,CER 101J-CH1H-CP
MECH-P.W.Board			C1220	08S45231Y25	CAP,CER 101J-CH1H-CP
MECH-P.W.Board			C1221	08S45231Y25	CAP,CER 101J-CH1H-CP
MECH-P.W.Board			C1222	08S45676W93	CAP,CER 224K-B1A -CP
MECH-P.W.Board			C1301	08S45232Y06	CAP,CER 152K-B1H -CP
MECH-P.W.Board			C1302	08S45231Y29	CAP,CER 221J-CH1H-CP
MECH-P.W.Board			C1303	08S45676W85	CAP,CER 104K-B1C -CP
MECH-P.W.Board			C1304	08S45676W85	CAP,CER 104K-B1C -CP
MECH-P.W.Board			C1305	08S45676W85	CAP,CER 104K-B1C -CP
MECH-P.W.Board			C1306	08S45231Y22	CAP,CER 56RJ-CH1H-CP
MECH-P.W.Board			C1307	08S45231Y21	CAP,CER 47RJ-CH1H-CP
MECH-P.W.Board			C1311	08S45676W66	CAP,CER.272K-B1H -CP
MECH-P.W.Board			C1312	08S45676W75	CAP,CER.153K-B1H -CP
MECH-P.W.Board			C1313	08S45232Y17	CAP,CER 104K-B0J -CP
MECH-P.W.Board			C1315	08S45676W85	CAP,CER 104K-B1C -CP
MECH-P.W.Board			C1316	08T81833F12	CAP,CER 106K-B1A -CP
MECH-P.W.Board			C1321	08S45677W60	CAP,CER 102J-CH1H-CP
MECH-P.W.Board			C1322	08S45677W60	CAP,CER 102J-CH1H-CP
MECH-P.W.Board			C1330	08S35349Y17	CAP,CER 225K-B0J -CP
MECH-P.W.Board			C1602	08S45232Y17	CAP,CER 104K-B0J -CP
MECH-P.W.Board			C1603	08S45232Y17	CAP,CER 104K-B0J -CP
MECH-P.W.Board			C1604	08S45232Y08	CAP,CER 332K-B1H -CP
MECH-P.W.Board			C1605	08T65555Y01	CAP,CER 226K-BJ0J-CP
MECH-P.W.Board			C1610	08S35374W11	CAP,CER 475K-B0J -CP
MECH-P.W.Board			C1611	08S35374W12	CAP,CER 106K-B0J -CP
MECH-P.W.Board			C1625	08S45232Y08	CAP,CER 332K-B1H -CP
MECH-P.W.Board			C1626	08S45232Y08	CAP,CER 332K-B1H -CP
MECH-P.W.Board			C1628	08S45232Y08	CAP,CER 332K-B1H -CP
MECH-P.W.Board			C1700	08S45232Y06	CAP,CER 152K-B1H -CP
MECH-P.W.Board			C1701	08S45232Y06	CAP,CER 152K-B1H -CP
MECH-P.W.Board			C1703	08S35374W11	CAP,CER 475K-B0J -CP
MECH-P.W.Board			C1708	08S35374W12	CAP,CER 106K-B0J -CP
MECH-P.W.Board			CB1101	09-09312Z02	FFC,IMSA9663S-15Y-EQ
MECH-P.W.Board			CB1201	09-11476Z01	BTB,IMSA9852S-22Y-EQ

Mark Model Code

#1 CDA-9884 Only,

\$1 CDA-9884E (General Foreign) Only,

%1 CDA-9884E (Chinese) Only,

&1 CDA-9884Li Only,

Others:Common.

NOTE:The part that has not PART NUMBER will not be supplied.

P.W.Board	MIS	MODEL	Ref.	Parts No.	Parts Name
MECH-P.W.Board			CB1202	09-09031Z01	WTB,SM06B-SHLS-TF-E5
MECH-P.W.Board			CB1301	09-09312Z01	FFC,IMSA9663S-11Y-EQ
MECH-P.W.Board			E1101	23-02425Z02	CAP,ELY 47R-05 -E5
MECH-P.W.Board			E1103	23T65679Y11	CAP,CD 47R-0J -E2
MECH-P.W.Board			E1301	23-02425Z04	CAP,ELY 10R-1C -E5
MECH-P.W.Board			E1601	23-02425Z02	CAP,ELY 47R-05 -E5
MECH-P.W.Board			E1603	23-02425Z02	CAP,ELY 47R-05 -E5
MECH-P.W.Board			IC1100	51-06875Z03	TC94A70FG-007 -QT
MECH-P.W.Board			IC1200	51-07740Z01	TC7SA00FU-L -CP
MECH-P.W.Board			IC1201	51-12485Z01	IC,TMP92CD28AFG -QT
MECH-P.W.Board			IC1301	51-01027Z01	BA5830FP-E2 -SEA
MECH-P.W.Board			IC1600	51-06963Z01	NJU7741F15-TE1 -CP
MECH-P.W.Board			IC1601	51-06963Z01	NJU7741F15-TE1 -CP
MECH-P.W.Board			Q1001	48T55462Y01	TR,2SB1132-QR-100-E2
MECH-P.W.Board			Q1200	48T65135Y03	TR,2SA1298-Y-85L -CP
MECH-P.W.Board			Q1201	48T64222F12	TR,UN221L-TX -CP
MECH-P.W.Board			Q1600	48T55462Y02	TR,2SB1132-R-T100-E2
MECH-P.W.Board			Q1601	48T45251W09	TR,UN521F-TX -CP
MECH-P.W.Board			Q1602	48T94606F06	TR,DTC114EUA-T106-CP
MECH-P.W.Board			Q1603	48T62966F23	TR,DTA123YKA-T146-CP
MECH-P.W.Board			R1010	06S45675W43	RES,RK JUMPER1/10-CP
MECH-P.W.Board			R1011	06S15616Y23	RES,RK JUMPER1/16-CP
MECH-P.W.Board			R1012	06S45675W43	RES,RK JUMPER1/10-CP
MECH-P.W.Board			R1013	06S70072F90	RES,CP .1R0-J-1/4-CP
MECH-P.W.Board			R1014	06S15616Y23	RES,RK JUMPER1/16-CP
MECH-P.W.Board			R1015	06S45674W99	RES,RK 563J 1/10 -CP
MECH-P.W.Board			R1111	06S45674W89	RES,RK 223J 1/10 -CP
MECH-P.W.Board			R1114	06S45675W30	RES,RK 105J 1/10 -CP
MECH-P.W.Board			R1115	06S15594Y23	RES,RK JUMPER1/10-CP
MECH-P.W.Board			R1117	06S45674W97	RES,RK 473J 1/10 -CP
MECH-P.W.Board			R1118	06S45674W41	RES,RK 221J 1/10 -CP
MECH-P.W.Board			R1120	06S45674W97	RES,RK 473J 1/10 -CP
MECH-P.W.Board			R1121	06S45675W06	RES,RK 104J 1/10 -CP
MECH-P.W.Board			R1131	06S45675W18	RES,RK 334J 1/10 -CP
MECH-P.W.Board			R1134	06S45675W06	RES,RK 104J 1/10 -CP
MECH-P.W.Board			R1160	06S45674W75	RES,RK 562J 1/10 -CP
MECH-P.W.Board			R1161	06S45674W85	RES,RK 153J 1/10 -CP
MECH-P.W.Board			R1162	06S45674W97	RES,RK 473J 1/10 -CP
MECH-P.W.Board			R1163	06S45675W26	RES,RK 684J 1/10 -CP

Mark Model Code

#1 CDA-9884 Only,

\$1 CDA-9884E (General Foreign) Only,

%1 CDA-9884E (Chinese) Only,

&1 CDA-9884Li Only,

Others:Common.

NOTE:The part that has not PART NUMBER will not be supplied.

P.W.Board	MIS	MODEL	Ref.	Parts No.	Parts Name
MECH-P.W.Board			R1168	06S15616Y23	RES,RK JUMPER1/16-CP
MECH-P.W.Board			R1200	06S55361Y41	RES,RK 101J 1/4 -CP
MECH-P.W.Board			R1201	06S45674W33	RES,RK 101J 1/10 -CP
MECH-P.W.Board			R1202	06S55361Y41	RES,RK 101J 1/4 -CP
MECH-P.W.Board			R1203	06S55365Y93	RES,RK 153J 1/10 -CP
MECH-P.W.Board			R1204	06S55365Y93	RES,RK 153J 1/10 -CP
MECH-P.W.Board			R1205	06S45675W43	RES,RK JUMPER1/10-CP
MECH-P.W.Board			R1207	06S45674W97	RES,RK 473J 1/10 -CP
MECH-P.W.Board			R1208	06S45674W97	RES,RK 473J 1/10 -CP
MECH-P.W.Board			R1209	06S45674W57	RES,RK 102J 1/10 -CP
MECH-P.W.Board			R1210	06S45674W97	RES,RK 473J 1/10 -CP
MECH-P.W.Board			R1212	06S45674W97	RES,RK 473J 1/10 -CP
MECH-P.W.Board			R1213	06S45674W97	RES,RK 473J 1/10 -CP
MECH-P.W.Board			R1215	06S45674W97	RES,RK 473J 1/10 -CP
MECH-P.W.Board			R1216	06S15594Y23	RES,RK JUMPER1/10-CP
MECH-P.W.Board			R1218	06S45674W97	RES,RK 473J 1/10 -CP
MECH-P.W.Board			R1219	06S45674W33	RES,RK 101J 1/10 -CP
MECH-P.W.Board			R1220	06S45674W33	RES,RK 101J 1/10 -CP
MECH-P.W.Board			R1221	06S45674W97	RES,RK 473J 1/10 -CP
MECH-P.W.Board			R1222	06S45674W97	RES,RK 473J 1/10 -CP
MECH-P.W.Board			R1223	06S45674W97	RES,RK 473J 1/10 -CP
MECH-P.W.Board			R1224	06S45674W97	RES,RK 473J 1/10 -CP
MECH-P.W.Board			R1226	06S45674W97	RES,RK 473J 1/10 -CP
MECH-P.W.Board			R1227	06S45675W06	RES,RK 104J 1/10 -CP
MECH-P.W.Board			R1228	06S45675W43	RES,RK JUMPER1/10-CP
MECH-P.W.Board			R1229	06S45674W97	RES,RK 473J 1/10 -CP
MECH-P.W.Board			R1230	06S45675W43	RES,RK JUMPER1/10-CP
MECH-P.W.Board			R1232	06S45674W97	RES,RK 473J 1/10 -CP
MECH-P.W.Board			R1237	06S45674W97	RES,RK 473J 1/10 -CP
MECH-P.W.Board			R1238	06S45674W33	RES,RK 101J 1/10 -CP
MECH-P.W.Board			R1239	06S15615Y73	RES,RK 103J 1/16 -CP
MECH-P.W.Board			R1240	06S45674W51	RES,RK 561J 1/10 -CP
MECH-P.W.Board			R1301	06S45675W02	RES,RK 683J 1/10 -CP
MECH-P.W.Board			R1302	06S45675W04	RES,RK 823J 1/10 -CP
MECH-P.W.Board			R1303	06S45675W06	RES,RK 104J 1/10 -CP
MECH-P.W.Board			R1304	06S45675W06	RES,RK 104J 1/10 -CP
MECH-P.W.Board			R1305	06S45675W08	RES,RK 124J 1/10 -CP
MECH-P.W.Board			R1306	06S45674W99	RES,RK 563J 1/10 -CP
MECH-P.W.Board			R1307	06S45674W33	RES,RK 101J 1/10 -CP

Mark Model Code

#1 CDA-9884 Only,

\$1 CDA-9884E (General Foreign) Only,

%1 CDA-9884E (Chinese) Only,

&1 CDA-9884Li Only,

Others:Common.

NOTE:The part that has not PART NUMBER will not be supplied.

P.W.Board	MIS	MODEL	Ref.	Parts No.	Parts Name
MECH-P.W.Board			R1308	06S45674W33	RES,RK 101J 1/10 -CP
MECH-P.W.Board			R1313	06S45674W97	RES,RK 473J 1/10 -CP
MECH-P.W.Board			R1314	06S45674W93	RES,RK 333J 1/10 -CP
MECH-P.W.Board			R1317	06S45674W75	RES,RK 562J 1/10 -CP
MECH-P.W.Board			R1318	06S45674W75	RES,RK 562J 1/10 -CP
MECH-P.W.Board			R1319	06S45674W87	RES,RK 183J 1/10 -CP
MECH-P.W.Board			R1320	06S45674W99	RES,RK 563J 1/10 -CP
MECH-P.W.Board			R1323	06S45674W33	RES,RK 101J 1/10 -CP
MECH-P.W.Board			R1324	06S45674W33	RES,RK 101J 1/10 -CP
MECH-P.W.Board			R1325	06S45675W06	RES,RK 104J 1/10 -CP
MECH-P.W.Board			R1326	06S45675W06	RES,RK 104J 1/10 -CP
MECH-P.W.Board			R1327	06S45675W06	RES,RK 104J 1/10 -CP
MECH-P.W.Board			R1328	06S45675W43	RES,RK JUMPER1/10-CP
MECH-P.W.Board			R1329	06S45674W81	RES,RK 103J 1/10 -CP
MECH-P.W.Board			R1602	06S45674W93	RES,RK 333J 1/10 -CP
MECH-P.W.Board			R1620	06S45674W73	RES,RK 472J 1/10 -CP
MECH-P.W.Board			R1621	06S45674W39	RES,RK 181J 1/10 -CP
MECH-P.W.Board			R1700	06S45674W19	RES,RK 27RJ 1/10 -CP
MECH-P.W.Board			R1701	06S45674W19	RES,RK 27RJ 1/10 -CP
MECH-P.W.Board			R1702	06S15594Y23	RES,RK JUMPER1/10-CP
MECH-P.W.Board			R1703	06S15594Y23	RES,RK JUMPER1/10-CP
MECH-P.W.Board			RA1100	06S45591W15	RES,ARY MNR472J 4-CP
MECH-P.W.Board			RA1101	06S45591W15	RES,ARY MNR472J 4-CP
MECH-P.W.Board			RA1102	06S15771Y45	RES,ARYEXB28V473J-CP
MECH-P.W.Board			RA1103	06S15771Y49	RES,ARYEXB28V104J-CP
MECH-P.W.Board			RA1105	06S15771Y13	RES,ARYEXB28V101J-CP
MECH-P.W.Board			RA1202	06S15771Y13	RES,ARYEXB28V101J-CP
MECH-P.W.Board			RA1203	06S15771Y13	RES,ARYEXB28V101J-CP
MECH-P.W.Board			RA1204	06S15771Y13	RES,ARYEXB28V101J-CP
MECH-P.W.Board			RA1205	06S15771Y13	RES,ARYEXB28V101J-CP
MECH-P.W.Board			RA1208	06S15771Y13	RES,ARYEXB28V101J-CP
MECH-P.W.Board			RA1210	06S15771Y45	RES,ARYEXB28V473J-CP
MECH-P.W.Board			RA1211	06S15771Y45	RES,ARYEXB28V473J-CP
MECH-P.W.Board			RA1212	06S15771Y45	RES,ARYEXB28V473J-CP
MECH-P.W.Board			RA1213	06S15771Y45	RES,ARYEXB28V473J-CP
MECH-P.W.Board			RA1214	06S15771Y45	RES,ARYEXB28V473J-CP
MECH-P.W.Board			RA1215	06S15771Y45	RES,ARYEXB28V473J-CP
MECH-P.W.Board			RA1216	06S15771Y45	RES,ARYEXB28V473J-CP
MECH-P.W.Board			RA1217	06S15771Y45	RES,ARYEXB28V473J-CP

Mark Model Code

#1 CDA-9884 Only,









\$1 CDA-9884E (General Foreign) Only,

%1 CDA-9884E (Chinese) Only,

&1 CDA-9884Li Only,

Others:Common.

NOTE:The part that has not PART NUMBER will not be supplied.

P.W.Board	MIS	MODEL	Ref.	Parts No.	Parts Name
MECH-P.W.Board			XL1100	91T45637Y08	XTL,CMR309T 16.9M-E9
MECH-P.W.Board			XL1200	91T45637Y44	XTL,CMR309T 9.00M-E9
MECH-P.W.Board			XL1201	91-11474Z01	XTL,CM315 32.76K -E1
MECH-P.W.Board			Z1200	91T65123Y02	EMI,DLW21SN900SQ2-CP
ESC-P.W.Board			CB6001	09T75237Y20	BTB,BTFW20P-3SSTA-EJ
ESC-P.W.Board			CB6002	09-04217Z01	BTB,DH16-S -B
ESC-P.W.Board			LD6001	48-11865Z01	LED,AMB SML-D12D8WCP
ESC-P.W.Board			LD6002	48-11868Z01	LED,AMB SML-A12D8TCP
ESC-P.W.Board			LD6003	48-11868Z01	LED,AMB SML-A12D8TCP
ESC-P.W.Board			Q6001	48-04929Z05	TR,KRC105S-RTK -CP
ESC-P.W.Board			R6001	06S35095Y16	RES,RK 303J 1/4 -CP
ESC-P.W.Board			R6002	06S70072F96	RES,RK 153J 1/4 -CP
ESC-P.W.Board			SW6001	40-03466Z01	SW,DETCT SPVM1101-E5
ESC-P.W.Board			SW6002	40T65353Y01	SW,TACT SKRSPACE010E2
ESC-P.W.Board			ZD6001	48-02645Z22	DIO,ZEN MAZ80560L-CP
Miscellaneous			ET5001	09-09122Z01	ASSY,ANID-0050-01A
Miscellaneous		\$1	ET802	09-11953Z01	ASSY,YAF11-1251N
Miscellaneous		%1	ET802	09-11953Z01	ASSY,YAF11-1251N
DP33U8B0			C101	08S45677W42	CAP,CER.181J-CH1H-CP
DP33U8B0			C102	08S45677W42	CAP,CER.181J-CH1H-CP
DP33U8B0			C103	08S45677W42	CAP,CER.181J-CH1H-CP
DP33U8B0			LD101	48-01591Z01	LED,AN1105W-1-TR -CP
DP33U8B0			LD102	48-01591Z01	LED,AN1105W-1-TR -CP
DP33U8B0			LD103	48-01591Z01	LED,AN1105W-1-TR -CP
DP33U8B0			R101	06S45674W51	RES,RK 561J 1/10 -CP
DP33U8B0			R102	06S45674W51	RES,RK 561J 1/10 -CP
DP33U8B0			R103	06S45674W51	RES,RK 561J 1/10 -CP
DP33U8B0			CB101	09-09314Z01	FFC,IMSA9664S-11Y-EQ
DP33U8B0			PT1	48-04836Z01	PHT,TR PS1191RB22-CP
DP33U8B0			PT2	48-04836Z01	PHT,TR PS1191RB22-CP
DP33U8B0			PT3	48-04836Z01	PHT,TR PS1191RB22-CP
DP33U8B0			HD1	EP-01327Z01	EP21A95T
DP33U8B0			M1	66-09123Z07	ASSY,SPDL MTR AOTA
DP33U8B0			M2	66-09123Z08	ASSY,LD-SLED MTR AOTA
DP33U8B0			SW1	40T15494Y15	SW,DETCT SPVG1107-E6

Mark Model Code

#1 CDA-9884 Only,

\$1 CDA-9884E (General Foreign) Only,

%1 CDA-9884E (Chinese) Only,

&1 CDA-9884Li Only,

Others:Common.

NOTE:The part that has not PART NUMBER will not be supplied.

MODEL	Symbol No.	Parts No.	Description
#1	1	13-11408Z03	NOSE,PIECE ASSY
\$1	1	13-11408Z10	NOSE,PIECE ASSY
%1	1	13-11408Z10	NOSE,PIECE ASSY
&1	1	13-11408Z04	NOSE,PIECE ASSY
	2	-----	COVER, TOP
	3	-----	CHAS,RIV BASE
	9	03S60823Y33	SCR,P-T 2X4 ZN A
#1	12	-----	BKT,CHAS REAR
\$1	12	-----	BKT,CHAS REAR
%1	12	-----	BKT,CHAS REAR
&1	12	-----	BKT,CHAS REAR
	13	03S60825Y04	SCR,B-T 3X8 ZN A
	15	03S60822Y43	SCR,S-T 2X3 ZN A
	18	DP-08135Z01	DP33U8B0
	19	03-02876Z28	SCR,WEV 1.7X7 ZB A
	20	13-11222Z01	NOSE,BOTTOM
	21	36-11314Z01	KNOB,ROTARY ASSY
	22	14-08687Z01	INSULATOR,MAIN
	23	13-11315Z01	NOSE,BASE ASSY
	25	33-11449Z01	FACE,PLATE
	26	-----	HEAT,SINK
	28	03T25225Y01	SCR,GND
	29	03S60822Y10	SCR,S-T 2.6X5 ZN A
	31	84-09115Z01	FPC,SERVO DP-U AOTA
	33	14-07028Z02	INSULATOR,DP-U
	34	03S60822Y22	SCR,S-T 2.6X14 ZN A
	35	41-05515Z01	SPRING,OPEN
#1	37	SU-12598Z01	SERVICE_NOSE_9884
\$1	37	SU-12599Z01	SERVICE_NOSE_9884E
%1	37	SU-12599Z01	SERVICE_NOSE_9884E
&1	37	SU-12601Z01	SERVICE_NOSE_9884L
	38	36A04141K02	KNOB,SLIDE
\$1	43	09T84840F01	LUG,STYLE 18MM
%1	43	09T84840F01	LUG,STYLE 18MM
	46	15-08546Z02	COVER,LCD
	47	75T03213K03	RUBBER,ELECTRIC
	ANT001	09-06103Z01	ASSY,ANID-0035-01A
	CB401	09-04216Z01	BTB,DH16-P -B
	CB6002	09-04217Z01	BTB,DH16-S -B
	CB801	24-02502Z02	ASSY,W277A001 -DB
	DIN801	09T55071W11	CON,TCP9389-11 -DT

Mark Model Code

#1 CDA-9884 Only,

\$1 CDA-9884E (General Foreign) Only,

%1 CDA-9884E (Chinese) Only,

&1 CDA-9884Li Only,

Others:Common.

NOTE:The part that has not PART NUMBER will not be supplied.

MODEL	Symbol No.	Parts No.	Description
	ET5001	09-09122Z01	ASSY,ANID-0050-01A
\$1	ET802	09-11953Z01	ASSY,YAF11-1251N
%1	ET802	09-11953Z01	ASSY,YAF11-1251N
	JK1200	09-11352Z01	RCA,YKC21-4816N -DB
	JK601	09T03156K01	JAC,CK-3.5-14 -DB
	LCD401	65-10797Z01	LCD,TB2115BMM0TTN-F
	SW420	40-10735Z01	ENC,EC12D1524401 -DB
	SW501	40T16096W03	SW ,TACT SKHHLW
	SW6001	40-03466Z01	SW,DETCT SPVM1101-E5
	TU001	TU-04070Z04	TUNER,TFTE1U113C

Mark Model Code

#1 CDA-9884 Only,

\$1 CDA-9884E (General Foreign) Only,

%1 CDA-9884E (Chinese) Only,

&1 CDA-9884Li Only,

Others:Common.

NOTE:The part that has not PART NUMBER will not be supplied.

Exploded View(CD Deck Mechanism)

(DP33U8B0)

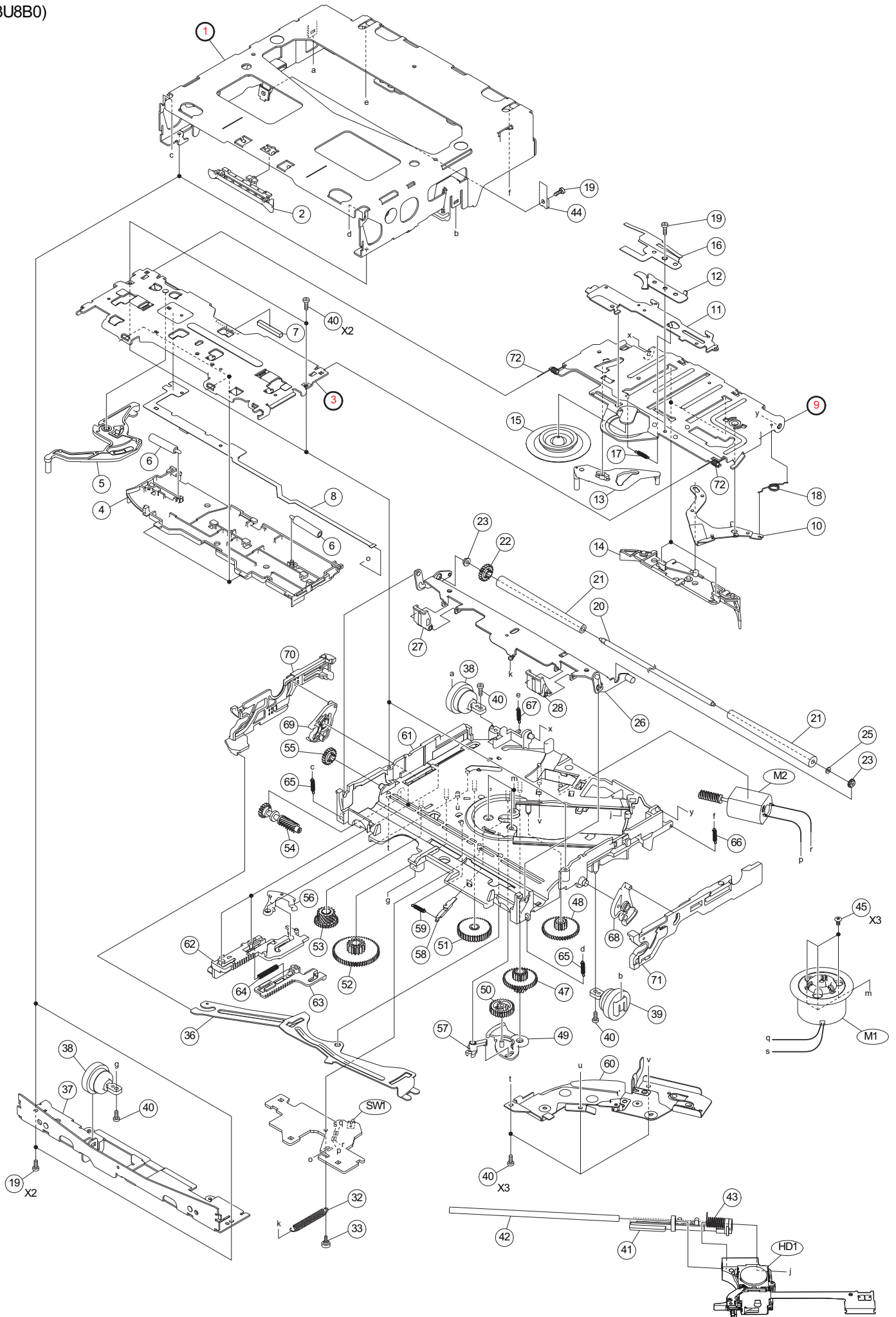

MODEL	Symbol No.	Parts No.	Description
	<u>1</u>	-----	CHAS,BASE DP-U
	<u>2</u>	15-08614Z01	GUIDE, TOP 2 DP-U
	<u>3</u>	-----	CHAS, TOP DP-U
	<u>4</u>	15-08613Z01	GUIDE, TOP DP-U
	<u>5</u>	45-08629Z01	LEVER, DISC DP-U
	<u>6</u>	49-08644Z01	ROLLER, TOP
	<u>7</u>	14-06145Z26	INS, CVR 12X2.7XT2
	<u>8</u>	84-05912Z01	FPC, PHOTO DP-U
	<u>9</u>	-----	ARM, CLAMP DP-U
	<u>10</u>	45-04869Z02	LEVER, RETURN
	<u>11</u>	45-08656Z01	LEVER, LOCK 8CM DP-U
	<u>12</u>	07-04871Z02	BKT, CLAMPER
	<u>13</u>	45-08635Z01	LEVER, ACTUATOR DP-U
	<u>14</u>	45-08636Z01	SLIDER, DISC DP-U
	<u>15</u>	43-08616Z01	TABLE, CLAMPER DP-U
	<u>16</u>	41-05525Z02	SPG, CLAMPER THRUST
	<u>17</u>	41-05867Z08	SPRING, LEV. LOCK 8CM
	<u>18</u>	41A11609Y02	SPRING, LEVER
	<u>19</u>	03S60822Y43	SCR, S-T 2X3 ZN A
	<u>20</u>	47-04894Z01	SHAFT, ROLLER DP-U
	<u>21</u>	49-07008Z02	ROLLER, DP-U
	<u>22</u>	44-08626Z01	GEAR, ROLLER
	<u>23</u>	43-08617Z01	BUSH, ROLLER DP-U
	<u>25</u>	04S40075G88	WAS, LOC 1.7X4.5X0.25
	<u>26</u>	45-08511Z01	ARM, DISC GUIDE AOTA
	<u>27</u>	45-08642Z01	ARM, FENCE L
	<u>28</u>	45-08643Z01	ARM, FENCE R
	<u>32</u>	41-05867Z11	SPRING, ROLLER AOTA 2
	<u>33</u>	03-10564Z01	SCR, SPG. ROLLER AOTA2
	<u>36</u>	45-08510Z01	LEVER, LINK DRIVE
	<u>37</u>	07-04867Z02	BKT, DAMPER
	<u>38</u>	75-03979Z03	DAMPER, DP-U Z03
	<u>39</u>	75-03979Z04	DAMPER, DP-U Z04
	<u>40</u>	03S70693Y06	SCR, P-T 2X6 ZB A
	<u>41</u>	44-08628Z01	RACK, SLED
	<u>42</u>	47-04895Z01	SHAFT, PICK DP-U
	<u>43</u>	41-05866Z01	SPRING, SLED
	<u>44</u>	41-09325Z01	SPRING, RATTLE L
	<u>45</u>	03S60820Y72	SCR, MCH 1.7X3 ZN A
	<u>47</u>	44-08618Z01	GEAR, A
	<u>48</u>	44-08619Z01	GEAR, B

Mark Model Code

#1 CDA-9884 Only,

\$1 CDA-9884E (General Foreign) Only,

%1 CDA-9884E (Chinese) Only,

&1 CDA-9884Li Only,

Others: Common.

NOTE: The part that has not PART NUMBER will not be supplied.

MODEL	Symbol No.	Parts No.	Description
	49	45-08631Z01	LEVER,TIMING GEAR
	50	44-08620Z01	GEAR,C
	51	44-08621Z01	GEAR,D
	52	44-08622Z01	GEAR,E
	53	44-08623Z01	GEAR,F
	54	44-08624Z01	GEAR,G
	55	44-09654Z01	GEAR,H-2
	56	45-08632Z01	LEVER,LOCK DP-U
	57	45-08630Z01	LEVER,TIMING PICK
	58	45-08641Z01	LEVER,SPINDLE
	59	41-05867Z05	SPRING,SPINDLE
	60	07-05523Z02	ASSY,RIV COVER MTR
	61	27-08330Z01	CHAS,PICK DP-U AOTA
	62	45-08633Z01	SLIDER,LOAD DP-U
	63	45-08634Z01	SLIDER,TIMING_LOAD
	64	41-05874Z01	SPRING,TIMING
	65	41-05867Z02	SPRING,DRIVE F
	66	41-05867Z03	SPRING,DRIVE RR
	67	41-05867Z04	SPRING,DRIVE RL
	68	45-08639Z01	ARM,LOCK R DP-U
	69	45-08637Z01	ARM,LOCK L DP-U
	70	45-08638Z01	SLIDER,LOCK L DP-U
	71	45-08640Z01	SLIDER,LOCK R DP-U
	72	41-05871Z01	SPRING,ARM CLAMP
	HD1	EP-01327Z01	EP21A95T
	M1	66-09123Z07	ASSY,SPDL MTR AOTA
	M2	66-09123Z08	ASSY,LD-SLED MTR AOTA
	SW1	40T15494Y16	SW,DETCT SPVG1103-E6

Mark Model Code

#1 CDA-9884 Only,

\$1 CDA-9884E (General Foreign) Only,

%1 CDA-9884E (Chinese) Only,

&1 CDA-9884Li Only,

Others:Common.

NOTE:The part that has not PART NUMBER will not be supplied.