

# Exploded View (Cabinet) (1/2)

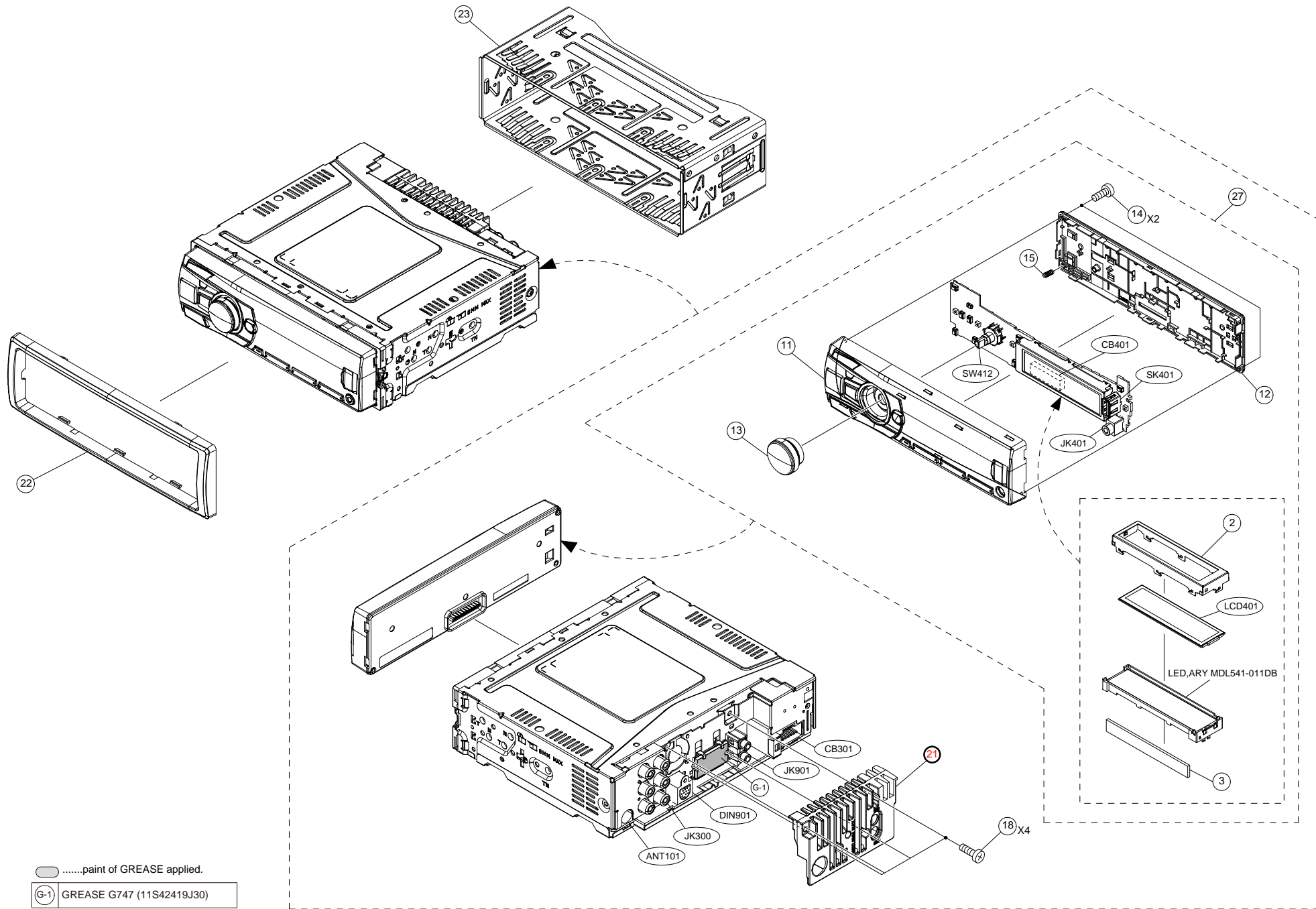

.....paint of GREASE applied.

G-1 GREASE G747 (11S42419J30)

Exploded View (Cabinet) (2/2)

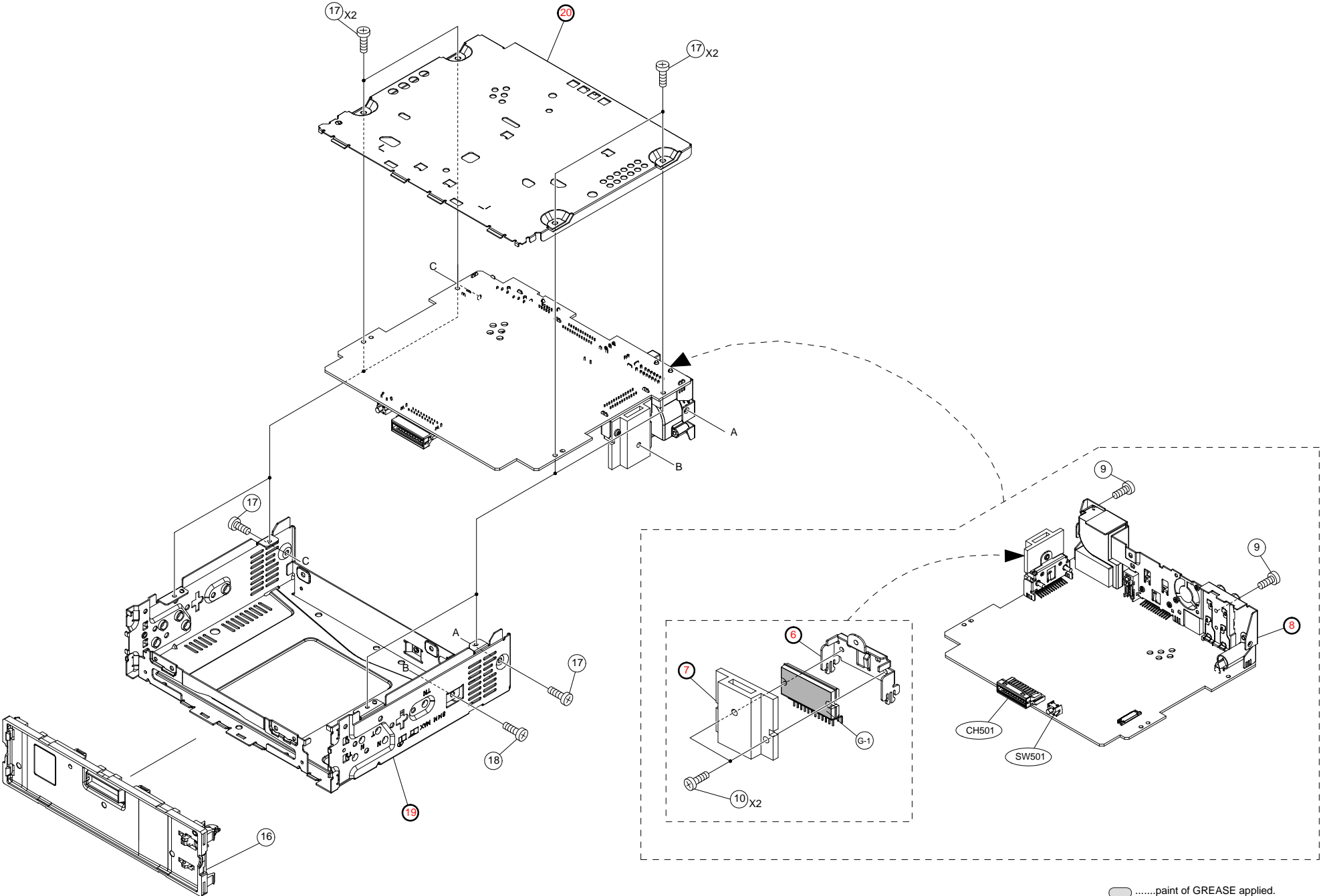

.....paint of GREASE applied.

G-1 GREASE G747 (11S42419J30)

MODEL	Symbol No.	Parts No.	Description
	<a href="#">2</a>	15-26770Z01	COVER,LCD
	<a href="#">3</a>	75-27131Z01	RUBBER,GSS
	<a href="#">6</a>	-----	BKT,IC SYS
	<a href="#">7</a>	-----	HEAT,SINK SYS
	<a href="#">8</a>	-----	BKT,CHAS REAR
	<a href="#">9</a>	03S60825Y04	SCR,B-T 3X8 ZN A
	<a href="#">10</a>	03S60822Y22	SCR,S-T 2.6X14 ZN A
	<a href="#">11</a>	EN-27371Z01	NOSE,PIECE ASSY
	<a href="#">12</a>	13-27126Z01	NOSE,BOTTOM
	<a href="#">13</a>	36-23793Z01	KNOB,ROTARY ASSY
	<a href="#">14</a>	03-02876Z28	SCR,WEV 1.7X7 ZB A
	<a href="#">15</a>	41-05515Z01	SPRING,OPEN
	<a href="#">16</a>	EN-24496Z03	NOSE,BASE ASSY
	<a href="#">17</a>	03S60822Y13	SCR,S-T 2.6X6 ZN A
	<a href="#">18</a>	03S60822Y22	SCR,S-T 2.6X14 ZN A
	<a href="#">19</a>	-----	CHAS,BASE
	<a href="#">20</a>	-----	COVER,BOTTOM
	<a href="#">21</a>	-----	HEAT,SINK PWR
	<a href="#">22</a>	33-23980Z01	FACE,PLATE
	<a href="#">23</a>	15-24381Z01	CASE,INNER
	<a href="#">27</a>	SU-28159Z01	SERVICE_NOSE_52BT
	<a href="#">ANT101</a>	09-26262Z01	ANT,ARL43.644.692-DB
	<a href="#">CB301</a>	09-28001Z01	ASSY,A090A0101 -DB
	<a href="#">CB401</a>	09-18716Z01	BTB,DF20-P -EJ
	<a href="#">CH501</a>	09-18738Z01	BTB,DF20-S -DB
	<a href="#">DIN901</a>	09-18874Z01	DIN,TCS7718-012117DB
	<a href="#">JK300</a>	09-25331Z01	RCA,RJ-1346B09-0H0DB
	<a href="#">JK401</a>	09-27672Z01	JAC,CK-3552 -DB
	<a href="#">JK901</a>	09-14149Z01	JAC,CK3-3.5-14D -DB
	<a href="#">LCD401</a>	65-26734Z01	LCD,EI0222M0TTN(S)
	<a href="#">SK401</a>	09-19382Z01	SKT,CM-V105 -DB
	<a href="#">SW412</a>	40-10735Z02	ENC,EC12D1524405 -DB
	<a href="#">SW501</a>	40T16096W03	SW ,TACT SKHHLW

Model Code  
UTE-52BT

NOTE:The part that has not PART NUMBER will not be supplied

# Packing Method View

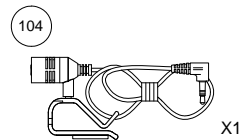
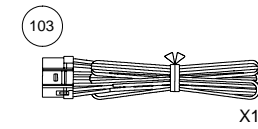
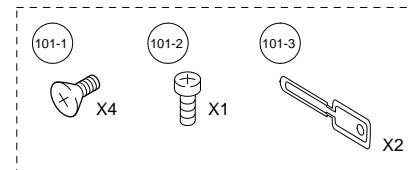
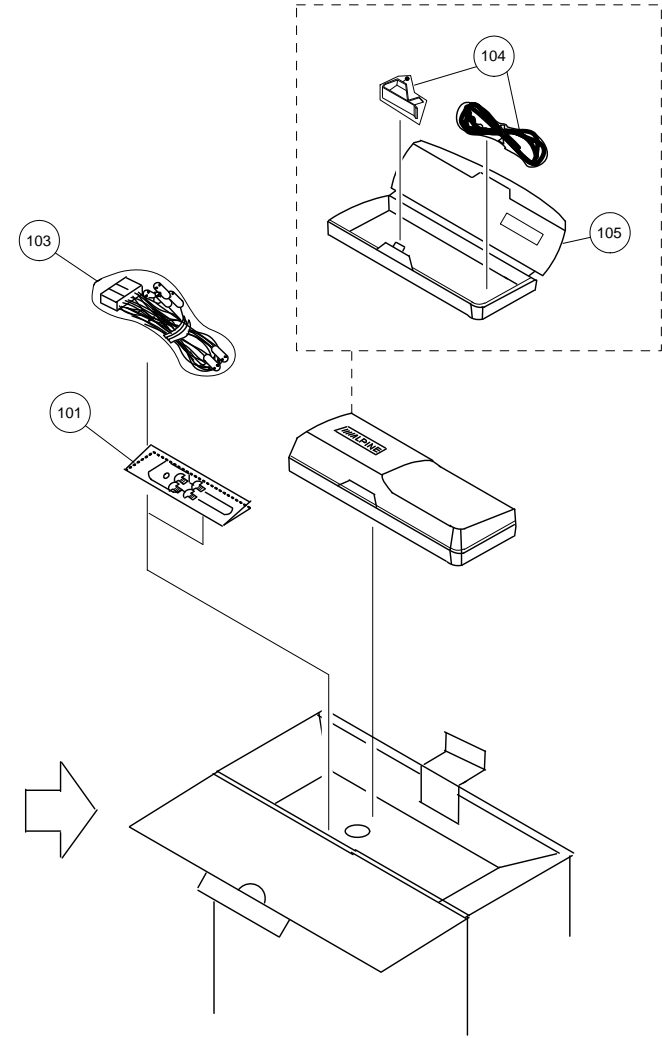
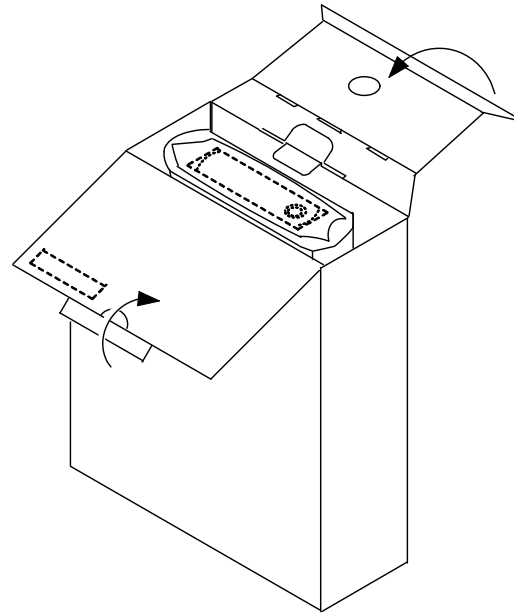
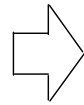
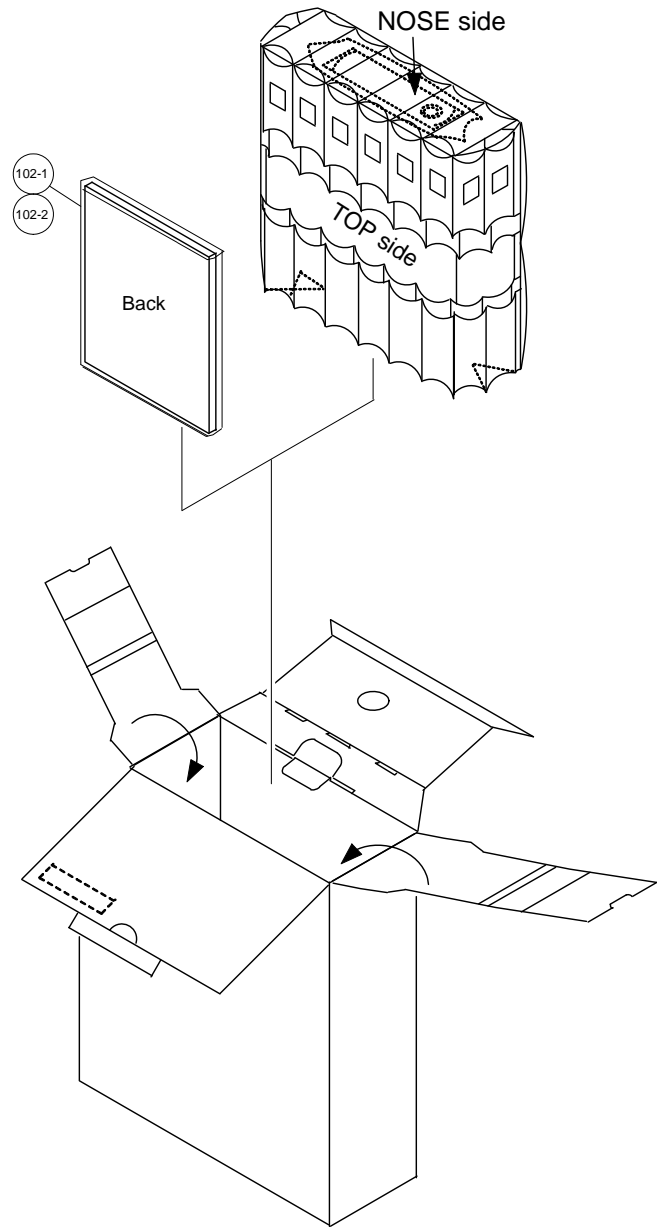

MODEL	Symbol No.	Parts No.	Description
	<a href="#">101-1</a>	03S60820Y16	SCR,MCH 5X8 ZN A
	<a href="#">101-2</a>	03S60824Y01	SCR,WEV 1.7X4 ZN A
	<a href="#">101-3</a>	07-24382Z01	BKT,RELEASE
	<a href="#">102-1</a>	68-10334Z64	O/M-CDROM AOTH
	<a href="#">102-2</a>	68-24567Z33	C/N-QRG AOAM AOTH
	<a href="#">103</a>	09-25214Z03	ASSY,ATTC-0081-03A
	<a href="#">104</a>	50-14386Z03	ASSY,LYS-M9750-FUL
	<a href="#">105</a>	15-24676Z01	CARRYING,CASE ASSY

Model Code  
UTE-52BT

NOTE:The part that has not PART NUMBER will not be supplied.

P.W.Board	MIS	MODEL	Ref.	Parts No.	Parts Name
-----------	-----	-------	------	-----------	------------

MAIN-P.W.Board			<a href="#">ANT101</a>	09-26262Z01	ANT,ARL43.644.692-DB
MAIN-P.W.Board			<a href="#">C101</a>	08S35349Y16	CAP,CER 105K-B1A -CP
MAIN-P.W.Board			<a href="#">C103</a>	08S45231Y38	CAP,CER 102J-CH1H-CP
MAIN-P.W.Board			<a href="#">C104</a>	08S35374W12	CAP,CER 106K-B0J -CP
MAIN-P.W.Board			<a href="#">C105</a>	08S35374W12	CAP,CER 106K-B0J -CP
MAIN-P.W.Board			<a href="#">C106</a>	08S35374W12	CAP,CER 106K-B0J -CP
MAIN-P.W.Board			<a href="#">C107</a>	08S35374W12	CAP,CER 106K-B0J -CP
MAIN-P.W.Board			<a href="#">C108</a>	08S45231Y38	CAP,CER 102J-CH1H-CP
MAIN-P.W.Board			<a href="#">C109</a>	08S45676W65	CAP,CER.222K-B1H -CP
MAIN-P.W.Board			<a href="#">C110</a>	08S35374W12	CAP,CER 106K-B0J -CP
MAIN-P.W.Board			<a href="#">C111</a>	08S35374W12	CAP,CER 106K-B0J -CP
MAIN-P.W.Board			<a href="#">C112</a>	08S35374W12	CAP,CER 106K-B0J -CP
MAIN-P.W.Board			<a href="#">C114</a>	08S45232Y17	CAP,CER 104K-B0J -CP
MAIN-P.W.Board			<a href="#">C115</a>	08S35374W12	CAP,CER 106K-B0J -CP
MAIN-P.W.Board			<a href="#">C116</a>	08S45231Y06	CAP,CER 3R0C-CJ1H-CP
MAIN-P.W.Board			<a href="#">C117</a>	08S45677W60	CAP,CER 102J-CH1H-CP
MAIN-P.W.Board			<a href="#">C118</a>	08S45232Y17	CAP,CER 104K-B0J -CP
MAIN-P.W.Board			<a href="#">C119</a>	08S65670Y01	CAP,CER 106KX5R1C-CP
MAIN-P.W.Board			<a href="#">C120</a>	08S45232Y17	CAP,CER 104K-B0J -CP
MAIN-P.W.Board			<a href="#">C121</a>	08S45232Y05	CAP,CER 102K-B1H -CP
MAIN-P.W.Board			<a href="#">C122</a>	08S35349Y17	CAP,CER 225K-B0J -CP
MAIN-P.W.Board			<a href="#">C123</a>	08S35374W11	CAP,CER 475K-B0J -CP
MAIN-P.W.Board			<a href="#">C125</a>	08S45232Y17	CAP,CER 104K-B0J -CP
MAIN-P.W.Board			<a href="#">C126</a>	08S45232Y17	CAP,CER 104K-B0J -CP
MAIN-P.W.Board			<a href="#">C127</a>	08S45232Y08	CAP,CER 332K-B1H -CP
MAIN-P.W.Board			<a href="#">C128</a>	08S45232Y05	CAP,CER 102K-B1H -CP
MAIN-P.W.Board			<a href="#">C129</a>	08S45232Y05	CAP,CER 102K-B1H -CP
MAIN-P.W.Board			<a href="#">C131</a>	08S45677W34	CAP,CER.82RJ-CH1H-CP
MAIN-P.W.Board			<a href="#">C132</a>	08S45231Y17	CAP,CER 22RJ-CH1H-CP
MAIN-P.W.Board			<a href="#">C141</a>	08S45231Y25	CAP,CER 101J-CH1H-CP
MAIN-P.W.Board			<a href="#">C142</a>	08S45231Y13	CAP,CER 10RD-CH1H-CP
MAIN-P.W.Board			<a href="#">C143</a>	08S45232Y03	CAP,CER 471K-B1H -CP
MAIN-P.W.Board			<a href="#">C145</a>	08S45677W60	CAP,CER 102J-CH1H-CP
MAIN-P.W.Board			<a href="#">C153</a>	08S45231Y38	CAP,CER 102J-CH1H-CP
MAIN-P.W.Board			<a href="#">C154</a>	08S45231Y16	CAP,CER 18RJ-CH1H-CP
MAIN-P.W.Board			<a href="#">C155</a>	08S45232Y07	CAP,CER 222K-B1H -CP
MAIN-P.W.Board			<a href="#">C160</a>	08S45676W73	CAP,CER.103K-B1H -CP
MAIN-P.W.Board			<a href="#">C161</a>	08S45676W73	CAP,CER.103K-B1H -CP
MAIN-P.W.Board			<a href="#">C162</a>	08S65668Y05	CAP,CER 224KX5R1A-CP
MAIN-P.W.Board			<a href="#">C163</a>	08S45231Y15	CAP,CER 15RJ-CH1H-CP
MAIN-P.W.Board			<a href="#">C164</a>	08S45231Y14	CAP,CER 12RJ-CH1H-CP

Model Code  
UTE-52BT

NOTE:The part that has not PART NUMBER will not be supplied.

IC501(\*) :51-27561Z01(W25Q32FVSSIG -ST)  
Software is not written in to the part indicated with (\*).

P.W.Board	MIS	MODEL	Ref.	Parts No.	Parts Name
-----------	-----	-------	------	-----------	------------

MAIN-P.W.Board			<a href="#">C165</a>	08S45231Y38	CAP,CER 102J-CH1H-CP
MAIN-P.W.Board			<a href="#">C166</a>	08S65670Y01	CAP,CER 106KX5R1C-CP
MAIN-P.W.Board			<a href="#">C167</a>	08S45232Y17	CAP,CER 104K-B0J -CP
MAIN-P.W.Board			<a href="#">C168</a>	08S45232Y17	CAP,CER 104K-B0J -CP
MAIN-P.W.Board			<a href="#">C169</a>	08S45231Y38	CAP,CER 102J-CH1H-CP
MAIN-P.W.Board			<a href="#">C170</a>	08S65670Y01	CAP,CER 106KX5R1C-CP
MAIN-P.W.Board			<a href="#">C171</a>	08S35374W12	CAP,CER 106K-B0J -CP
MAIN-P.W.Board			<a href="#">C172</a>	08S35374W12	CAP,CER 106K-B0J -CP
MAIN-P.W.Board			<a href="#">C173</a>	08S35374W12	CAP,CER 106K-B0J -CP
MAIN-P.W.Board			<a href="#">C174</a>	08S35374W12	CAP,CER 106K-B0J -CP
MAIN-P.W.Board			<a href="#">C175</a>	08S45231Y38	CAP,CER 102J-CH1H-CP
MAIN-P.W.Board			<a href="#">C176</a>	08S45231Y38	CAP,CER 102J-CH1H-CP
MAIN-P.W.Board			<a href="#">C300</a>	08S45676W73	CAP,CER.103K-B1H -CP
MAIN-P.W.Board			<a href="#">C302</a>	08S35350Y04	CAP,CER 105K-B1C -CP
MAIN-P.W.Board			<a href="#">C303</a>	08S65669Y03	CAP,CER 224KX7R1H-CP
MAIN-P.W.Board			<a href="#">C304</a>	08S45676W80	CAP,CER 223K-B1E -CP
MAIN-P.W.Board			<a href="#">C305</a>	08S65669Y03	CAP,CER 224KX7R1H-CP
MAIN-P.W.Board			<a href="#">C307</a>	08S65669Y03	CAP,CER 224KX7R1H-CP
MAIN-P.W.Board			<a href="#">C312</a>	08S65676Y07	CAP,CER 225K-X7R1ECP
MAIN-P.W.Board			<a href="#">C313</a>	08S65676Y07	CAP,CER 225K-X7R1ECP
MAIN-P.W.Board			<a href="#">C314</a>	08S65669Y03	CAP,CER 224KX7R1H-CP
MAIN-P.W.Board			<a href="#">C316</a>	08S65669Y03	CAP,CER 224KX7R1H-CP
MAIN-P.W.Board			<a href="#">C320</a>	08S35350Y04	CAP,CER 105K-B1C -CP
MAIN-P.W.Board			<a href="#">C321</a>	08S65669Y03	CAP,CER 224KX7R1H-CP
MAIN-P.W.Board			<a href="#">C322</a>	08S65669Y03	CAP,CER 224KX7R1H-CP
MAIN-P.W.Board			<a href="#">C323</a>	08S65669Y03	CAP,CER 224KX7R1H-CP
MAIN-P.W.Board			<a href="#">C324</a>	08S65669Y03	CAP,CER 224KX7R1H-CP
MAIN-P.W.Board			<a href="#">C325</a>	08S35350Y04	CAP,CER 105K-B1C -CP
MAIN-P.W.Board			<a href="#">C326</a>	08S65669Y03	CAP,CER 224KX7R1H-CP
MAIN-P.W.Board			<a href="#">C327</a>	08S45232Y14	CAP,CER 333K-B1C -CP
MAIN-P.W.Board			<a href="#">C501</a>	08S45676W85	CAP,CER 104K-B1C -CP
MAIN-P.W.Board			<a href="#">C502</a>	08S45676W85	CAP,CER 104K-B1C -CP
MAIN-P.W.Board			<a href="#">C503</a>	08S45676W85	CAP,CER 104K-B1C -CP
MAIN-P.W.Board			<a href="#">C504</a>	08S65669Y03	CAP,CER 224KX7R1H-CP
MAIN-P.W.Board			<a href="#">C505</a>	08S45232Y07	CAP,CER 222K-B1H -CP
MAIN-P.W.Board			<a href="#">C506</a>	08S65668Y05	CAP,CER 224KX5R1A-CP
MAIN-P.W.Board			<a href="#">C507</a>	08S45677W60	CAP,CER 102J-CH1H-CP
MAIN-P.W.Board			<a href="#">C508</a>	08S45232Y07	CAP,CER 222K-B1H -CP
MAIN-P.W.Board			<a href="#">C509</a>	08S45232Y07	CAP,CER 222K-B1H -CP
MAIN-P.W.Board			<a href="#">C514</a>	08S45232Y11	CAP,CER 103K-B1C -CP
MAIN-P.W.Board			<a href="#">C515</a>	08S45232Y07	CAP,CER 222K-B1H -CP

Model Code  
UTE-52BT

NOTE:The part that has not PART NUMBER will not be supplied.

IC501(\*) :51-27561Z01(W25Q32FVSSIG -ST)  
Software is not written in to the part indicated with (\*).

P.W.Board	MIS	MODEL	Ref.	Parts No.	Parts Name
-----------	-----	-------	------	-----------	------------

MAIN-P.W.Board			<a href="#">C516</a>	08S45232Y05	CAP,CER 102K-B1H -CP
MAIN-P.W.Board			<a href="#">C517</a>	08S45232Y17	CAP,CER 104K-B0J -CP
MAIN-P.W.Board			<a href="#">C518</a>	08S45676W85	CAP,CER 104K-B1C -CP
MAIN-P.W.Board			<a href="#">C519</a>	08S45232Y05	CAP,CER 102K-B1H -CP
MAIN-P.W.Board			<a href="#">C523</a>	08S45232Y17	CAP,CER 104K-B0J -CP
MAIN-P.W.Board			<a href="#">C524</a>	08S45676W85	CAP,CER 104K-B1C -CP
MAIN-P.W.Board			<a href="#">C525</a>	08S45676W85	CAP,CER 104K-B1C -CP
MAIN-P.W.Board			<a href="#">C526</a>	08S45676W85	CAP,CER 104K-B1C -CP
MAIN-P.W.Board			<a href="#">C527</a>	08S45232Y17	CAP,CER 104K-B0J -CP
MAIN-P.W.Board			<a href="#">C528</a>	08S45676W85	CAP,CER 104K-B1C -CP
MAIN-P.W.Board			<a href="#">C529</a>	08S45676W85	CAP,CER 104K-B1C -CP
MAIN-P.W.Board			<a href="#">C530</a>	08S45232Y17	CAP,CER 104K-B0J -CP
MAIN-P.W.Board			<a href="#">C531</a>	08S45676W85	CAP,CER 104K-B1C -CP
MAIN-P.W.Board			<a href="#">C533</a>	08S45676W85	CAP,CER 104K-B1C -CP
MAIN-P.W.Board			<a href="#">C534</a>	08S45676W85	CAP,CER 104K-B1C -CP
MAIN-P.W.Board			<a href="#">C535</a>	08S45232Y21	CAP,CER 104K-B1A-CP
MAIN-P.W.Board			<a href="#">C536</a>	08S45232Y21	CAP,CER 104K-B1A-CP
MAIN-P.W.Board			<a href="#">C537</a>	08S45676W85	CAP,CER 104K-B1C -CP
MAIN-P.W.Board			<a href="#">C538</a>	08S45676W85	CAP,CER 104K-B1C -CP
MAIN-P.W.Board			<a href="#">C539</a>	08S45676W85	CAP,CER 104K-B1C -CP
MAIN-P.W.Board			<a href="#">C540</a>	08S45232Y17	CAP,CER 104K-B0J -CP
MAIN-P.W.Board			<a href="#">C541</a>	08S45676W85	CAP,CER 104K-B1C -CP
MAIN-P.W.Board			<a href="#">C542</a>	08S45676W85	CAP,CER 104K-B1C -CP
MAIN-P.W.Board			<a href="#">C543</a>	08S45676W85	CAP,CER 104K-B1C -CP
MAIN-P.W.Board			<a href="#">C544</a>	08S45676W85	CAP,CER 104K-B1C -CP
MAIN-P.W.Board			<a href="#">C545</a>	08S45676W85	CAP,CER 104K-B1C -CP
MAIN-P.W.Board			<a href="#">C546</a>	08S45676W85	CAP,CER 104K-B1C -CP
MAIN-P.W.Board			<a href="#">C547</a>	08S45231Y15	CAP,CER 15RJ-CH1H-CP
MAIN-P.W.Board			<a href="#">C548</a>	08S45231Y15	CAP,CER 15RJ-CH1H-CP
MAIN-P.W.Board			<a href="#">C549</a>	08S65668Y05	CAP,CER 224KX5R1A-CP
MAIN-P.W.Board			<a href="#">C550</a>	08S35349Y16	CAP,CER 105K-B1A -CP
MAIN-P.W.Board			<a href="#">C551</a>	08S35349Y16	CAP,CER 105K-B1A -CP
MAIN-P.W.Board			<a href="#">C552</a>	08S65669Y03	CAP,CER 224KX7R1H-CP
MAIN-P.W.Board			<a href="#">C554</a>	08S45676W85	CAP,CER 104K-B1C -CP
MAIN-P.W.Board			<a href="#">C555</a>	08S45676W69	CAP,CER.472K-B1H -CP
MAIN-P.W.Board			<a href="#">C556</a>	08S45232Y03	CAP,CER 471K-B1H -CP
MAIN-P.W.Board			<a href="#">C561</a>	08S45676W73	CAP,CER.103K-B1H -CP
MAIN-P.W.Board			<a href="#">C562</a>	08S45676W80	CAP,CER 223K-B1E -CP
MAIN-P.W.Board			<a href="#">C601</a>	08S45232Y05	CAP,CER 102K-B1H -CP
MAIN-P.W.Board			<a href="#">C602</a>	08S45231Y13	CAP,CER 10RD-CH1H-CP
MAIN-P.W.Board			<a href="#">C603</a>	08S35374W12	CAP,CER 106K-B0J -CP

Model Code  
UTE-52BT

NOTE:The part that has not PART NUMBER will not be supplied.

IC501(\*) :51-27561Z01(W25Q32FVSSIG -ST)  
Software is not written in to the part indicated with (\*).

P.W.Board	MIS	MODEL	Ref.	Parts No.	Parts Name
-----------	-----	-------	------	-----------	------------



MAIN-P.W.Board			<a href="#">C604</a>	08S45232Y05	CAP,CER 102K-B1H -CP
MAIN-P.W.Board			<a href="#">C605</a>	08S45232Y05	CAP,CER 102K-B1H -CP
MAIN-P.W.Board			<a href="#">C606</a>	08S35374W12	CAP,CER 106K-B0J -CP
MAIN-P.W.Board			<a href="#">C607</a>	08S35374W12	CAP,CER 106K-B0J -CP
MAIN-P.W.Board			<a href="#">C608</a>	08S35374W12	CAP,CER 106K-B0J -CP
MAIN-P.W.Board			<a href="#">C609</a>	08S45232Y17	CAP,CER 104K-B0J -CP
MAIN-P.W.Board			<a href="#">C610</a>	08S35374W12	CAP,CER 106K-B0J -CP
MAIN-P.W.Board			<a href="#">C611</a>	08S45232Y17	CAP,CER 104K-B0J -CP
MAIN-P.W.Board			<a href="#">C612</a>	08S45232Y05	CAP,CER 102K-B1H -CP
MAIN-P.W.Board			<a href="#">C613</a>	08S45231Y13	CAP,CER 10RD-CH1H-CP
MAIN-P.W.Board			<a href="#">C614</a>	08S45232Y05	CAP,CER 102K-B1H -CP
MAIN-P.W.Board			<a href="#">C615</a>	08S45231Y13	CAP,CER 10RD-CH1H-CP
MAIN-P.W.Board			<a href="#">C616</a>	08S35349Y12	CAP,CER 105K-B0J -CP
MAIN-P.W.Board			<a href="#">C617</a>	08S45232Y05	CAP,CER 102K-B1H -CP
MAIN-P.W.Board			<a href="#">C618</a>	08S35349Y12	CAP,CER 105K-B0J -CP
MAIN-P.W.Board			<a href="#">C619</a>	08S35349Y12	CAP,CER 105K-B0J -CP
MAIN-P.W.Board			<a href="#">C620</a>	08S45232Y17	CAP,CER 104K-B0J -CP
MAIN-P.W.Board			<a href="#">C621</a>	08S45232Y17	CAP,CER 104K-B0J -CP
MAIN-P.W.Board			<a href="#">C623</a>	08S45231Y04	CAP,CER 1R5C-CK1H-CP
MAIN-P.W.Board			<a href="#">C624</a>	08S45231Y12	CAP,CER 9R0D-CH1H-CP
MAIN-P.W.Board			<a href="#">C625</a>	08S45231Y13	CAP,CER 10RD-CH1H-CP
MAIN-P.W.Board			<a href="#">C801</a>	08S45232Y21	CAP,CER 104K-B1A-CP
MAIN-P.W.Board			<a href="#">C802</a>	08S45232Y12	CAP,CER 153K-B1C -CP
MAIN-P.W.Board			<a href="#">C803</a>	08S45676W74	CAP,CER 123K-B1H -CP
MAIN-P.W.Board			<a href="#">C804</a>	08S45232Y01	CAP,CER 221K-B1H -CP
MAIN-P.W.Board			<a href="#">C805</a>	08S45232Y07	CAP,CER 222K-B1H -CP
MAIN-P.W.Board			<a href="#">C809</a>	08S65669Y03	CAP,CER 224KX7R1H-CP
MAIN-P.W.Board			<a href="#">C810</a>	08S45232Y21	CAP,CER 104K-B1A-CP
MAIN-P.W.Board			<a href="#">C811</a>	08S35349Y16	CAP,CER 105K-B1A -CP
MAIN-P.W.Board			<a href="#">C812</a>	08S35374W12	CAP,CER 106K-B0J -CP
MAIN-P.W.Board			<a href="#">C813</a>	08S65670Y07	CAP,CER 105KX5R1H-CP
MAIN-P.W.Board			<a href="#">C814</a>	08S65669Y03	CAP,CER 224KX7R1H-CP
MAIN-P.W.Board			<a href="#">C815</a>	08S65128F88	CAP,CER 104K-B1H -CP
MAIN-P.W.Board			<a href="#">C816</a>	08S35349Y16	CAP,CER 105K-B1A -CP
MAIN-P.W.Board			<a href="#">C817</a>	08S65669Y03	CAP,CER 224KX7R1H-CP
MAIN-P.W.Board			<a href="#">C818</a>	08S65669Y03	CAP,CER 224KX7R1H-CP
MAIN-P.W.Board			<a href="#">C819</a>	08S65669Y03	CAP,CER 224KX7R1H-CP
MAIN-P.W.Board			<a href="#">C820</a>	08S65669Y03	CAP,CER 224KX7R1H-CP
MAIN-P.W.Board			<a href="#">C821</a>	08S65669Y03	CAP,CER 224KX7R1H-CP
MAIN-P.W.Board			<a href="#">C823</a>	08S45232Y05	CAP,CER 102K-B1H -CP
MAIN-P.W.Board			<a href="#">C824</a>	08S45676W73	CAP,CER.103K-B1H -CP

Model Code  
UTE-52BT

NOTE:The part that has not PART NUMBER will not be supplied.

IC501(\*) :51-27561Z01(W25Q32FVSSIG -ST)  
Software is not written in to the part indicated with (\*).

P.W.Board	MIS	MODEL	Ref.	Parts No.	Parts Name
-----------	-----	-------	------	-----------	------------

MAIN-P.W.Board			<a href="#">C825</a>	08S45676W89	CAP,CER 473K-B1E -CP
MAIN-P.W.Board			<a href="#">C826</a>	08S65669Y03	CAP,CER 224KX7R1H-CP
MAIN-P.W.Board			<a href="#">C827</a>	08S65669Y03	CAP,CER 224KX7R1H-CP
MAIN-P.W.Board			<a href="#">C829</a>	08S45676W85	CAP,CER 104K-B1C -CP
MAIN-P.W.Board			<a href="#">C830</a>	08S65669Y03	CAP,CER 224KX7R1H-CP
MAIN-P.W.Board			<a href="#">C835</a>	08S65669Y03	CAP,CER 224KX7R1H-CP
MAIN-P.W.Board			<a href="#">C836</a>	08S65669Y03	CAP,CER 224KX7R1H-CP
MAIN-P.W.Board			<a href="#">C838</a>	08S65670Y07	CAP,CER 105KX5R1H-CP
MAIN-P.W.Board			<a href="#">C839</a>	08S45231Y25	CAP,CER 101J-CH1H-CP
MAIN-P.W.Board			<a href="#">C840</a>	08S45677W36	CAP,CER.101J-CH1H-CP
MAIN-P.W.Board			<a href="#">C841</a>	08S45676W85	CAP,CER 104K-B1C -CP
MAIN-P.W.Board			<a href="#">C842</a>	08S35349Y12	CAP,CER 105K-B0J -CP
MAIN-P.W.Board			<a href="#">C843</a>	08S65669Y03	CAP,CER 224KX7R1H-CP
MAIN-P.W.Board			<a href="#">C844</a>	08S35374W12	CAP,CER 106K-B0J -CP
MAIN-P.W.Board			<a href="#">C846</a>	08S65128F88	CAP,CER 104K-B1H -CP
MAIN-P.W.Board			<a href="#">C901</a>	08S65668Y05	CAP,CER 224KX5R1A-CP
MAIN-P.W.Board			<a href="#">C902</a>	08S65669Y03	CAP,CER 224KX7R1H-CP
MAIN-P.W.Board			<a href="#">C903</a>	08S65669Y03	CAP,CER 224KX7R1H-CP
MAIN-P.W.Board			<a href="#">C905</a>	08S45676W85	CAP,CER 104K-B1C -CP
MAIN-P.W.Board			<a href="#">C906</a>	08S45232Y11	CAP,CER 103K-B1C -CP
MAIN-P.W.Board			<a href="#">C907</a>	08S45232Y13	CAP,CER 223K-B1C -CP
MAIN-P.W.Board			<a href="#">C908</a>	08S45676W65	CAP,CER.222K-B1H -CP
MAIN-P.W.Board			<a href="#">C911</a>	08S65668Y05	CAP,CER 224KX5R1A-CP
MAIN-P.W.Board			<a href="#">C913</a>	08S45676W65	CAP,CER.222K-B1H -CP
MAIN-P.W.Board			<a href="#">C917</a>	08S45539Y04	CAP,CER 103KX7R2J-CP
MAIN-P.W.Board			<a href="#">CB301</a>	09-28001Z01	ASSY,A090A0101 -DB
MAIN-P.W.Board			<a href="#">CH501</a>	09-18738Z01	BTB,DF20-S -DB
MAIN-P.W.Board			<a href="#">D101</a>	48-12230Z01	DIO,KDS226-RTK -CP
MAIN-P.W.Board			<a href="#">D300</a>	48-07016Z01	DIO,KDS181-RTK -CP
MAIN-P.W.Board			<a href="#">D301</a>	48-07016Z01	DIO,KDS181-RTK -CP
MAIN-P.W.Board			<a href="#">D302</a>	48T75446Y01	DIO,RR264M-400 -CP
MAIN-P.W.Board			<a href="#">D303</a>	48T75527Y01	DIO,ISR154-400 -E1
MAIN-P.W.Board			<a href="#">D304</a>	48-07016Z01	DIO,KDS181-RTK -CP
MAIN-P.W.Board			<a href="#">D305</a>	48-07016Z02	DIO,KDS184-RTK -CP
MAIN-P.W.Board			<a href="#">D307</a>	48-05965Z01	DIO,ISS361-L -CP
MAIN-P.W.Board			<a href="#">D309</a>	48-05828Z01	DIO,1N5406G-04 -
MAIN-P.W.Board			<a href="#">D800</a>	48-07015Z01	DIO,KDS160-RTK -CP
MAIN-P.W.Board			<a href="#">D802</a>	48T75527Y01	DIO,ISR154-400 -E1
MAIN-P.W.Board			<a href="#">D803</a>	48T75527Y01	DIO,ISR154-400 -E1
MAIN-P.W.Board			<a href="#">D804</a>	48-07015Z01	DIO,KDS160-RTK -CP
MAIN-P.W.Board			<a href="#">D806</a>	48-07015Z01	DIO,KDS160-RTK -CP

Model Code  
UTE-52BT

NOTE:The part that has not PART NUMBER will not be supplied.

IC501(\*) :51-27561Z01(W25Q32FVSSIG -ST)  
Software is not written in to the part indicated with (\*).

P.W.Board	MIS	MODEL	Ref.	Parts No.	Parts Name
-----------	-----	-------	------	-----------	------------

MAIN-P.W.Board			<a href="#">D807</a>	48-05965Z01	DIO,1SS361-L -CP
MAIN-P.W.Board			<a href="#">D901</a>	48-07016Z02	DIO,KDS184-RTK -CP
MAIN-P.W.Board			<a href="#">DIN901</a>	09-18874Z01	DIN,TCS7718-012117DB
MAIN-P.W.Board			<a href="#">E300</a>	23S65134W52	CAP,ELY 3R3-1V(3)-E2
MAIN-P.W.Board			<a href="#">E301</a>	23T75346W03	CAP,X-PRO 332-1C +
MAIN-P.W.Board			<a href="#">E302</a>	23T75234Y06	CAP,MAR 22R-1C-E55E3
MAIN-P.W.Board			<a href="#">E303</a>	23S65134W52	CAP,ELY 3R3-1V(3)-E2
MAIN-P.W.Board			<a href="#">E304</a>	23T75234Y19	CAP,MAR 101-1C-H63E6
MAIN-P.W.Board			<a href="#">E305</a>	23S65134W52	CAP,ELY 3R3-1V(3)-E2
MAIN-P.W.Board			<a href="#">E306</a>	23S65134W52	CAP,ELY 3R3-1V(3)-E2
MAIN-P.W.Board			<a href="#">E307</a>	23S65134W52	CAP,ELY 3R3-1V(3)-E2
MAIN-P.W.Board			<a href="#">E308</a>	23S65134W52	CAP,ELY 3R3-1V(3)-E2
MAIN-P.W.Board			<a href="#">E309</a>	23T75234Y20	CAP,MAR 22R-1E-F55E6
MAIN-P.W.Board			<a href="#">E311</a>	23S65134W34	CAP,ELY 47R-1C(6)-E6
MAIN-P.W.Board			<a href="#">E312</a>	23S65134W53	CAP,ELY 4R7-1V(4)-E2
MAIN-P.W.Board			<a href="#">E313</a>	23S65134W53	CAP,ELY 4R7-1V(4)-E2
MAIN-P.W.Board			<a href="#">E314</a>	23S65134W53	CAP,ELY 4R7-1V(4)-E2
MAIN-P.W.Board			<a href="#">E315</a>	23S65134W53	CAP,ELY 4R7-1V(4)-E2
MAIN-P.W.Board			<a href="#">E316</a>	23T75234Y06	CAP,MAR 22R-1C-E55E3
MAIN-P.W.Board			<a href="#">E317</a>	23S65134W53	CAP,ELY 4R7-1V(4)-E2
MAIN-P.W.Board			<a href="#">E500</a>	23S65134W51	CAP,ELY 2R2-1V(3)-E2
MAIN-P.W.Board			<a href="#">E501</a>	23S65134W36	CAP,ELY 221-1C(8)-EA
MAIN-P.W.Board			<a href="#">E502</a>	23S65134W81	CAP,ELY 22R-1C(4)-E2
MAIN-P.W.Board			<a href="#">E801</a>	23S75244Y13	CAP,ELY 471-1A -EA
MAIN-P.W.Board			<a href="#">E802</a>	23S75244Y30	CAP,ELY 331-1E -EA
MAIN-P.W.Board			<a href="#">E803</a>	23S65134W13	CAP,ELY 101-0J(6)-E6
MAIN-P.W.Board			<a href="#">E809</a>	23S65134W54	CAP,ELY 10R-1V(5)-E3
MAIN-P.W.Board			<a href="#">E810</a>	23T75543Y01	CAP,MVA 331-0J -E6
MAIN-P.W.Board			<a href="#">E811</a>	23S65134W24	CAP,ELY 221-1A(8)-E6
MAIN-P.W.Board			<a href="#">E812</a>	23T75234Y19	CAP,MAR 101-1C-H63E6
MAIN-P.W.Board			<a href="#">E813</a>	23S75244Y28	CAP,ELY 101-1E -E6
MAIN-P.W.Board			<a href="#">E814</a>	23S65134W44	CAP,ELY 22R-1E(6)-E6
MAIN-P.W.Board			<a href="#">E818</a>	23S65134W47	CAP,ELY 101-1E(8)-E6
MAIN-P.W.Board			<a href="#">E823</a>	23S75244Y20	CAP,ELY 221-1C -E6
MAIN-P.W.Board			<a href="#">E824</a>	23S75244Y20	CAP,ELY 221-1C -E6
MAIN-P.W.Board			<a href="#">E825</a>	23S65134W15	CAP,ELY 331-0J(8)-E6
MAIN-P.W.Board			<a href="#">E901</a>	23S65134W81	CAP,ELY 22R-1C(4)-E2
MAIN-P.W.Board			<a href="#">E902</a>	23S65134W24	CAP,ELY 221-1A(8)-E6
MAIN-P.W.Board			<a href="#">E903</a>	23S65134W80	CAP,ELY 10R-1C(3)-E2
MAIN-P.W.Board			<a href="#">IC101</a>	51-22873Z01	TEA6636HW/V103 -QT
MAIN-P.W.Board			<a href="#">IC302</a>	51-28017Z01	BD37034FV-ME2 -SE6

Model Code  
UTE-52BT

NOTE:The part that has not PART NUMBER will not be supplied.

IC501(\*) :51-27561Z01(W25Q32FVSSIG -ST)  
Software is not written in to the part indicated with (\*).

P.W.Board	MIS	MODEL	Ref.	Parts No.	Parts Name
MAIN-P.W.Board			<a href="#">IC303</a>	51-27174Z01	TB2941HQ -ZS
MAIN-P.W.Board			<a href="#">IC501</a>	83-26452Z37	14MY_BT60_Low_A_IC501_Soft
MAIN-P.W.Board			<a href="#">IC501</a>	51-27561Z01	W25Q32FVSSIG -ST
MAIN-P.W.Board			<a href="#">IC504</a>	51-24717Z01	M24512-RMN6TP -SE2
MAIN-P.W.Board			<a href="#">IC505</a>	51-27561Z01	W25Q32FVSSIG -ST
MAIN-P.W.Board			<a href="#">IC506</a>	51-24658Z01	TMPM32BC2DFG -QT
MAIN-P.W.Board			<a href="#">IC507</a>	51-23872Z01	AK5701KN -LE2
MAIN-P.W.Board			<a href="#">IC601</a>	51-24902Z01	TC35661HDBG -BE6
MAIN-P.W.Board			<a href="#">IC801</a>	51-20097Z02	AN33012UB-VB -SE6
MAIN-P.W.Board			<a href="#">IC802</a>	51-23576Z01	S-1172B1C-E6T1U -SE2
MAIN-P.W.Board			<a href="#">IC803</a>	51-13711Z02	TB2920AHQ -ZS
MAIN-P.W.Board			<a href="#">IC804</a>	51-20765Z24	S-1009N30H-M5T2U -CP
MAIN-P.W.Board			<a href="#">IC806</a>	51-25207Z01	S-1172B33-U5T1U -NE2
MAIN-P.W.Board			<a href="#">IC807</a>	51-05862Z01	NJM2845DL1-33-TE1NE5
MAIN-P.W.Board			<a href="#">IC809</a>	51-20765Z36	S-1009N42H-M5T2U -CP
MAIN-P.W.Board			<a href="#">IC811</a>	51-13565Z03	NJM2856DL3-33TE1-NE5
MAIN-P.W.Board			<a href="#">IC901</a>	51-26850Z01	MFI337S3959 -CP
MAIN-P.W.Board			<a href="#">IC902</a>	51T93532F05	TC4S01F-TE85L -CP
MAIN-P.W.Board			<a href="#">IC903</a>	51-11433Z01	RT9702AGB -CP
MAIN-P.W.Board			<a href="#">IC904</a>	51-04637Z01	TC74ACT04FT-EL -SE5
MAIN-P.W.Board			<a href="#">JK300</a>	09-25331Z01	RCA,RJ-1346B09-0H0DB
MAIN-P.W.Board			<a href="#">JK901</a>	09-14149Z01	JAC,CK3-3.5-14D -DB
MAIN-P.W.Board			<a href="#">L101</a>	24T95456W11	FBI,BLM18AG601SH1-CP
MAIN-P.W.Board			<a href="#">L102</a>	24T95458W07	FBI,BLM31PG601SH1-CP
MAIN-P.W.Board			<a href="#">L103</a>	24T95456W11	FBI,BLM18AG601SH1-CP
MAIN-P.W.Board			<a href="#">L104</a>	24T95456W11	FBI,BLM18AG601SH1-CP
MAIN-P.W.Board			<a href="#">L105</a>	24T95456W11	FBI,BLM18AG601SH1-CP
MAIN-P.W.Board			<a href="#">L106</a>	24T45482Y05	IND,LQH31HN R29J -CP
MAIN-P.W.Board			<a href="#">L107</a>	24T25164Y12	IND,FSLM2520 R82J-CP
MAIN-P.W.Board			<a href="#">L108</a>	24T25164Y19	IND,FSLM2520 3R3J-CP
MAIN-P.W.Board			<a href="#">L109</a>	24T55488Y37	IND,LLQ1608 R27J -CP
MAIN-P.W.Board			<a href="#">L110</a>	24T65645Y03	IND,LLM3225 561K -CP
MAIN-P.W.Board			<a href="#">L111</a>	24T65645Y03	IND,LLM3225 561K -CP
MAIN-P.W.Board			<a href="#">L112</a>	24T95459W07	FBI,BLM41PG102SH1-E1
MAIN-P.W.Board			<a href="#">L113</a>	24T95456W11	FBI,BLM18AG601SH1-CP
MAIN-P.W.Board			<a href="#">L114</a>	24T65645Y01	IND,LLM3225 4R7J -CP
MAIN-P.W.Board			<a href="#">L501</a>	24-06212Z13	FBI,BLM15BB100SH1-CP
MAIN-P.W.Board			<a href="#">L502</a>	24-06212Z13	FBI,BLM15BB100SH1-CP
MAIN-P.W.Board			<a href="#">L503</a>	24-06212Z07	FBI,BLM15BD601SH1-CP
MAIN-P.W.Board			<a href="#">L504</a>	24-06212Z11	FBI,BLM15BD471SH1-CP
MAIN-P.W.Board			<a href="#">L505</a>	24-06212Z11	FBI,BLM15BD471SH1-CP

Model Code  
UTE-52BT

NOTE:The part that has not PART NUMBER will not be supplied.

IC501(\*) :51-27561Z01(W25Q32FVSSIG -ST)  
Software is not written in to the part indicated with (\*).

P.W.Board	MIS	MODEL	Ref.	Parts No.	Parts Name
-----------	-----	-------	------	-----------	------------

MAIN-P.W.Board			<a href="#">L506</a>	24-06212Z11	FBI,BLM15BD471SH1-CP
MAIN-P.W.Board			<a href="#">L507</a>	24-06212Z11	FBI,BLM15BD471SH1-CP
MAIN-P.W.Board			<a href="#">L801</a>	24-25206Z01	IND,SFCB1280T33RM-EA
MAIN-P.W.Board			<a href="#">PS901</a>	48-27319Z01	POLY,SW1812L150/24E2
MAIN-P.W.Board			<a href="#">Q101</a>	48-20742Z01	TR,BCX54 -E2
MAIN-P.W.Board			<a href="#">Q300</a>	48T75180Y04	TR,IMH23-T110 -CP
MAIN-P.W.Board			<a href="#">Q301</a>	48T75180Y04	TR,IMH23-T110 -CP
MAIN-P.W.Board			<a href="#">Q302</a>	48-13000Z05	TR,LTC124EUBFS8-TLCP
MAIN-P.W.Board			<a href="#">Q303</a>	48T75180Y04	TR,IMH23-T110 -CP
MAIN-P.W.Board			<a href="#">Q304</a>	48-04940Z01	TR,KRA101S-RTK -CP
MAIN-P.W.Board			<a href="#">Q306</a>	48-20093Z01	TR,DMC561010R -CP
MAIN-P.W.Board			<a href="#">Q308</a>	48-04929Z02	TR,KRC102S-RTK -CP
MAIN-P.W.Board			<a href="#">Q309</a>	48-04929Z03	TR,KRC103S-RTK -CP
MAIN-P.W.Board			<a href="#">Q310</a>	48T25737Y01	TR,UMD2N-TR -CP
MAIN-P.W.Board			<a href="#">Q801</a>	48T25737Y01	TR,UMD2N-TR -CP
MAIN-P.W.Board			<a href="#">Q802</a>	48-04929Z03	TR,KRC103S-RTK -CP
MAIN-P.W.Board			<a href="#">Q803</a>	48T25737Y01	TR,UMD2N-TR -CP
MAIN-P.W.Board			<a href="#">Q804</a>	48-09581Z04	TR,KTA1505S-GRRTK-CP
MAIN-P.W.Board			<a href="#">Q805</a>	48-20288Z01	FET,MTM981400BBF -E2
MAIN-P.W.Board			<a href="#">Q807</a>	48-19949Z01	TR,DRC5143X -CP
MAIN-P.W.Board			<a href="#">Q808</a>	48-09581Z04	TR,KTA1505S-GRRTK-CP
MAIN-P.W.Board			<a href="#">Q809</a>	48T25737Y01	TR,UMD2N-TR -CP
MAIN-P.W.Board			<a href="#">Q810</a>	48-17931Z01	TR,PBSS9110T -CP
MAIN-P.W.Board			<a href="#">Q811</a>	48-13000Z06	TR,LTC143XUBFS8-TLCP
MAIN-P.W.Board			<a href="#">Q812</a>	48-19949Z01	TR,DRC5143X -CP
MAIN-P.W.Board			<a href="#">Q901</a>	48-09583Z04	TR,KTA1504S-GRRTK-CP
MAIN-P.W.Board			<a href="#">Q902</a>	48-09583Z04	TR,KTA1504S-GRRTK-CP
MAIN-P.W.Board			<a href="#">Q903</a>	48-13000Z01	TR,LTC114EUBFS8-TLCP
MAIN-P.W.Board			<a href="#">Q904</a>	48-19949Z01	TR,DRC5143X -CP
MAIN-P.W.Board			<a href="#">Q905</a>	48T25737Y02	TR,UMD3N-TR -CP
MAIN-P.W.Board			<a href="#">Q906</a>	48-13000Z05	TR,LTC124EUBFS8-TLCP
MAIN-P.W.Board			<a href="#">R101</a>	06S15615Y25	RES,RK 101J 1/16 -CP
MAIN-P.W.Board			<a href="#">R102</a>	06S15616Y23	RES,RK JUMPER1/16-CP
MAIN-P.W.Board			<a href="#">R103</a>	06S15616Y23	RES,RK JUMPER1/16-CP
MAIN-P.W.Board			<a href="#">R104</a>	06S15616Y14	RES,RK 474J 1/16 -CP
MAIN-P.W.Board			<a href="#">R107</a>	06S15615Y25	RES,RK 101J 1/16 -CP
MAIN-P.W.Board			<a href="#">R109</a>	06S15615Y25	RES,RK 101J 1/16 -CP
MAIN-P.W.Board			<a href="#">R110</a>	06S15615Y25	RES,RK 101J 1/16 -CP
MAIN-P.W.Board			<a href="#">R111</a>	06S15616Y28	RES,RK 3R3J 1/16 -CP
MAIN-P.W.Board			<a href="#">R113</a>	06S15615Y25	RES,RK 101J 1/16 -CP
MAIN-P.W.Board			<a href="#">R121</a>	06S15616Y23	RES,RK JUMPER1/16-CP

Model Code  
UTE-52BT

NOTE:The part that has not PART NUMBER will not be supplied.

IC501(\*) :51-27561Z01(W25Q32FVSSIG -ST)  
Software is not written in to the part indicated with (\*).

P.W.Board	MIS	MODEL	Ref.	Parts No.	Parts Name
-----------	-----	-------	------	-----------	------------

MAIN-P.W.Board			<a href="#">R196</a>	06S65415Y11	RES,RK 68RF 1/16 -CP
MAIN-P.W.Board			<a href="#">R197</a>	06S45348Y38	RES,RK 474F 1/4 -CP
MAIN-P.W.Board			<a href="#">R206</a>	06S45348Y38	RES,RK 474F 1/4 -CP
MAIN-P.W.Board			<a href="#">R207</a>	06S15615Y25	RES,RK 101J 1/16 -CP
MAIN-P.W.Board			<a href="#">R219</a>	06S45674W57	RES,RK 102J 1/10 -CP
MAIN-P.W.Board			<a href="#">R220</a>	06S45674W57	RES,RK 102J 1/10 -CP
MAIN-P.W.Board			<a href="#">R221</a>	06S45674W57	RES,RK 102J 1/10 -CP
MAIN-P.W.Board			<a href="#">R222</a>	06S15615Y25	RES,RK 101J 1/16 -CP
MAIN-P.W.Board			<a href="#">R223</a>	06S45674W73	RES,RK 472J 1/10 -CP
MAIN-P.W.Board			<a href="#">R224</a>	06S45674W73	RES,RK 472J 1/10 -CP
MAIN-P.W.Board			<a href="#">R225</a>	06S45674W57	RES,RK 102J 1/10 -CP
MAIN-P.W.Board			<a href="#">R227</a>	06S15615Y49	RES,RK 102J 1/16 -CP
MAIN-P.W.Board			<a href="#">R228</a>	06S15615Y49	RES,RK 102J 1/16 -CP
MAIN-P.W.Board			<a href="#">R229</a>	06S15615Y49	RES,RK 102J 1/16 -CP
MAIN-P.W.Board			<a href="#">R230</a>	06S15615Y49	RES,RK 102J 1/16 -CP
MAIN-P.W.Board			<a href="#">R231</a>	06S15615Y48	RES,RK 911J 1/16 -CP
MAIN-P.W.Board			<a href="#">R232</a>	06S15615Y48	RES,RK 911J 1/16 -CP
MAIN-P.W.Board			<a href="#">R233</a>	06S15615Y48	RES,RK 911J 1/16 -CP
MAIN-P.W.Board			<a href="#">R300</a>	06S15593Y93	RES,RK 683F 1/10 -CP
MAIN-P.W.Board			<a href="#">R301</a>	06S70072F61	RES,CP .222-J-1/4-CP
MAIN-P.W.Board			<a href="#">R302</a>	06S15593Y93	RES,RK 683F 1/10 -CP
MAIN-P.W.Board			<a href="#">R303</a>	06S15593Y93	RES,RK 683F 1/10 -CP
MAIN-P.W.Board			<a href="#">R304</a>	06S45674W81	RES,RK 103J 1/10 -CP
MAIN-P.W.Board			<a href="#">R305</a>	06S70072F77	RES,CP .103-J-1/4-CP
MAIN-P.W.Board			<a href="#">R306</a>	06S15593Y93	RES,RK 683F 1/10 -CP
MAIN-P.W.Board			<a href="#">R307</a>	06S15615Y37	RES,RK 331J 1/16 -CP
MAIN-P.W.Board			<a href="#">R308</a>	06S15615Y37	RES,RK 331J 1/16 -CP
MAIN-P.W.Board			<a href="#">R309</a>	06S15593Y93	RES,RK 683F 1/10 -CP
MAIN-P.W.Board			<a href="#">R310</a>	06S15593Y93	RES,RK 683F 1/10 -CP
MAIN-P.W.Board			<a href="#">R311</a>	06S64995F37	RES,RK 221J 1/8 -CP
MAIN-P.W.Board			<a href="#">R312</a>	06S64995F37	RES,RK 221J 1/8 -CP
MAIN-P.W.Board			<a href="#">R313</a>	06S64995F37	RES,RK 221J 1/8 -CP
MAIN-P.W.Board			<a href="#">R314</a>	06S64995F37	RES,RK 221J 1/8 -CP
MAIN-P.W.Board			<a href="#">R315</a>	06S64995F37	RES,RK 221J 1/8 -CP
MAIN-P.W.Board			<a href="#">R316</a>	06S64995F37	RES,RK 221J 1/8 -CP
MAIN-P.W.Board			<a href="#">R317</a>	06S64995F29	RES,RK 101J 1/8 -CP
MAIN-P.W.Board			<a href="#">R318</a>	06S35095Y08	RES,RK JUMPER 1/4-CP
MAIN-P.W.Board			<a href="#">R319</a>	06S64995F29	RES,RK 101J 1/8 -CP
MAIN-P.W.Board			<a href="#">R320</a>	06S64995F29	RES,RK 101J 1/8 -CP
MAIN-P.W.Board			<a href="#">R321</a>	06S64995F29	RES,RK 101J 1/8 -CP
MAIN-P.W.Board			<a href="#">R322</a>	06S64995F29	RES,RK 101J 1/8 -CP

Model Code  
UTE-52BT

NOTE:The part that has not PART NUMBER will not be supplied.

IC501(\*) :51-27561Z01(W25Q32FVSSIG -ST)  
Software is not written in to the part indicated with (\*).

P.W.Board	MIS	MODEL	Ref.	Parts No.	Parts Name
-----------	-----	-------	------	-----------	------------

MAIN-P.W.Board			<a href="#">R323</a>	06S64995F29	RES,RK 101J 1/8 -CP
MAIN-P.W.Board			<a href="#">R324</a>	06S45674W85	RES,RK 153J 1/10 -CP
MAIN-P.W.Board			<a href="#">R325</a>	06S70072F77	RES,CP .103-J-1/4-CP
MAIN-P.W.Board			<a href="#">R326</a>	06S45674W92	RES,RK 303J 1/10 -CP
MAIN-P.W.Board			<a href="#">R344</a>	06S15615Y73	RES,RK 103J 1/16 -CP
MAIN-P.W.Board			<a href="#">R345</a>	06S45674W41	RES,RK 221J 1/10 -CP
MAIN-P.W.Board			<a href="#">R346</a>	06S15615Y77	RES,RK 153J 1/16 -CP
MAIN-P.W.Board			<a href="#">R347</a>	06S15615Y73	RES,RK 103J 1/16 -CP
MAIN-P.W.Board			<a href="#">R348</a>	06S15615Y25	RES,RK 101J 1/16 -CP
MAIN-P.W.Board			<a href="#">R349</a>	06S15615Y69	RES,RK 682J 1/16 -CP
MAIN-P.W.Board			<a href="#">R350</a>	06S70072F29	RES,CP .101-J-1/4-CP
MAIN-P.W.Board			<a href="#">R351</a>	06S15615Y25	RES,RK 101J 1/16 -CP
MAIN-P.W.Board			<a href="#">R500</a>	06S45675W43	RES,RK JUMPER1/10-CP
MAIN-P.W.Board			<a href="#">R501</a>	06S15615Y25	RES,RK 101J 1/16 -CP
MAIN-P.W.Board			<a href="#">R503</a>	06S45674W57	RES,RK 102J 1/10 -CP
MAIN-P.W.Board			<a href="#">R504</a>	06S45674W81	RES,RK 103J 1/10 -CP
MAIN-P.W.Board			<a href="#">R505</a>	06S70072F53	RES,CP .102-J-1/4-CP
MAIN-P.W.Board			<a href="#">R506</a>	06S15593Y73	RES,RK 103F 1/10 -CP
MAIN-P.W.Board			<a href="#">R507</a>	06S45674W57	RES,RK 102J 1/10 -CP
MAIN-P.W.Board			<a href="#">R508</a>	06S15615Y73	RES,RK 103J 1/16 -CP
MAIN-P.W.Board			<a href="#">R509</a>	06S15593Y73	RES,RK 103F 1/10 -CP
MAIN-P.W.Board			<a href="#">R510</a>	06S45674W57	RES,RK 102J 1/10 -CP
MAIN-P.W.Board			<a href="#">R511</a>	06S45674W57	RES,RK 102J 1/10 -CP
MAIN-P.W.Board			<a href="#">R512</a>	06S45674W57	RES,RK 102J 1/10 -CP
MAIN-P.W.Board			<a href="#">R513</a>	06S45674W57	RES,RK 102J 1/10 -CP
MAIN-P.W.Board			<a href="#">R514</a>	06S45674W57	RES,RK 102J 1/10 -CP
MAIN-P.W.Board			<a href="#">R515</a>	06S15594Y23	RES,RK JUMPER1/10-CP
MAIN-P.W.Board			<a href="#">R516</a>	06S45674W89	RES,RK 223J 1/10 -CP
MAIN-P.W.Board			<a href="#">R517</a>	06S45674W57	RES,RK 102J 1/10 -CP
MAIN-P.W.Board			<a href="#">R518</a>	06S15594Y23	RES,RK JUMPER1/10-CP
MAIN-P.W.Board			<a href="#">R519</a>	06S45674W57	RES,RK 102J 1/10 -CP
MAIN-P.W.Board			<a href="#">R520</a>	06S15594Y23	RES,RK JUMPER1/10-CP
MAIN-P.W.Board			<a href="#">R521</a>	06S45674W89	RES,RK 223J 1/10 -CP
MAIN-P.W.Board			<a href="#">R522</a>	06S15615Y89	RES,RK 473J 1/16 -CP
MAIN-P.W.Board			<a href="#">R523</a>	06S45674W81	RES,RK 103J 1/10 -CP
MAIN-P.W.Board			<a href="#">R524</a>	06S15615Y37	RES,RK 331J 1/16 -CP
MAIN-P.W.Board			<a href="#">R525</a>	06S15615Y49	RES,RK 102J 1/16 -CP
MAIN-P.W.Board			<a href="#">R526</a>	06S15616Y23	RES,RK JUMPER1/16-CP
MAIN-P.W.Board			<a href="#">R527</a>	06S15616Y23	RES,RK JUMPER1/16-CP
MAIN-P.W.Board			<a href="#">R528</a>	06S15616Y23	RES,RK JUMPER1/16-CP
MAIN-P.W.Board			<a href="#">R529</a>	06S15616Y23	RES,RK JUMPER1/16-CP

Model Code  
UTE-52BT

NOTE:The part that has not PART NUMBER will not be supplied.

IC501(\*) :51-27561Z01(W25Q32FVSSIG -ST)  
Software is not written in to the part indicated with (\*).

P.W.Board	MIS	MODEL	Ref.	Parts No.	Parts Name
-----------	-----	-------	------	-----------	------------

MAIN-P.W.Board			<a href="#">R530</a>	06S15616Y23	RES,RK JUMPER1/16-CP
MAIN-P.W.Board			<a href="#">R531</a>	06S15616Y23	RES,RK JUMPER1/16-CP
MAIN-P.W.Board			<a href="#">R532</a>	06S15616Y23	RES,RK JUMPER1/16-CP
MAIN-P.W.Board			<a href="#">R533</a>	06S15615Y77	RES,RK 153J 1/16 -CP
MAIN-P.W.Board			<a href="#">R534</a>	06S15615Y77	RES,RK 153J 1/16 -CP
MAIN-P.W.Board			<a href="#">R535</a>	06S65415Y09	RES,RK 47RF 1/16 -CP
MAIN-P.W.Board			<a href="#">R536</a>	06S65415Y09	RES,RK 47RF 1/16 -CP
MAIN-P.W.Board			<a href="#">R539</a>	06S45674W89	RES,RK 223J 1/10 -CP
MAIN-P.W.Board			<a href="#">R540</a>	06S15615Y89	RES,RK 473J 1/16 -CP
MAIN-P.W.Board			<a href="#">R541</a>	06S15615Y81	RES,RK 223J 1/16 -CP
MAIN-P.W.Board			<a href="#">R542</a>	06S15616Y23	RES,RK JUMPER1/16-CP
MAIN-P.W.Board			<a href="#">R543</a>	06S45674W89	RES,RK 223J 1/10 -CP
MAIN-P.W.Board			<a href="#">R544</a>	06S15615Y89	RES,RK 473J 1/16 -CP
MAIN-P.W.Board			<a href="#">R545</a>	06S15615Y37	RES,RK 331J 1/16 -CP
MAIN-P.W.Board			<a href="#">R546</a>	06S45675W43	RES,RK JUMPER1/10-CP
MAIN-P.W.Board			<a href="#">R547</a>	06S15615Y33	RES,RK 221J 1/16 -CP
MAIN-P.W.Board			<a href="#">R548</a>	06S15615Y37	RES,RK 331J 1/16 -CP
MAIN-P.W.Board			<a href="#">R549</a>	06S15615Y25	RES,RK 101J 1/16 -CP
MAIN-P.W.Board			<a href="#">R550</a>	06S15615Y89	RES,RK 473J 1/16 -CP
MAIN-P.W.Board			<a href="#">R551</a>	06S15615Y25	RES,RK 101J 1/16 -CP
MAIN-P.W.Board			<a href="#">R552</a>	06S15615Y37	RES,RK 331J 1/16 -CP
MAIN-P.W.Board			<a href="#">R553</a>	06S15615Y34	RES,RK 241J 1/16 -CP
MAIN-P.W.Board			<a href="#">R554</a>	06S15615Y25	RES,RK 101J 1/16 -CP
MAIN-P.W.Board			<a href="#">R555</a>	06S15615Y49	RES,RK 102J 1/16 -CP
MAIN-P.W.Board			<a href="#">R558</a>	06S45674W81	RES,RK 103J 1/10 -CP
MAIN-P.W.Board			<a href="#">R559</a>	06S15615Y25	RES,RK 101J 1/16 -CP
MAIN-P.W.Board			<a href="#">R560</a>	06S15615Y25	RES,RK 101J 1/16 -CP
MAIN-P.W.Board			<a href="#">R561</a>	06S15615Y73	RES,RK 103J 1/16 -CP
MAIN-P.W.Board			<a href="#">R562</a>	06S45674W81	RES,RK 103J 1/10 -CP
MAIN-P.W.Board			<a href="#">R564</a>	06S15615Y25	RES,RK 101J 1/16 -CP
MAIN-P.W.Board			<a href="#">R568</a>	06S45674W81	RES,RK 103J 1/10 -CP
MAIN-P.W.Board			<a href="#">R569</a>	06S45674W81	RES,RK 103J 1/10 -CP
MAIN-P.W.Board			<a href="#">R570</a>	06S15615Y25	RES,RK 101J 1/16 -CP
MAIN-P.W.Board			<a href="#">R571</a>	06S15615Y25	RES,RK 101J 1/16 -CP
MAIN-P.W.Board			<a href="#">R572</a>	06S45674W81	RES,RK 103J 1/10 -CP
MAIN-P.W.Board			<a href="#">R573</a>	06S45674W81	RES,RK 103J 1/10 -CP
MAIN-P.W.Board			<a href="#">R574</a>	06S64996F26	RES,RK 105J 1/8 -CP
MAIN-P.W.Board			<a href="#">R575</a>	06S15615Y25	RES,RK 101J 1/16 -CP
MAIN-P.W.Board			<a href="#">R576</a>	06S15615Y25	RES,RK 101J 1/16 -CP
MAIN-P.W.Board			<a href="#">R577</a>	06S15615Y59	RES,RK 272J 1/16 -CP
MAIN-P.W.Board			<a href="#">R578</a>	06S15615Y59	RES,RK 272J 1/16 -CP

Model Code  
UTE-52BT

NOTE:The part that has not PART NUMBER will not be supplied.

IC501(\*) :51-27561Z01(W25Q32FVSSIG -ST)  
Software is not written in to the part indicated with (\*).

P.W.Board	MIS	MODEL	Ref.	Parts No.	Parts Name
-----------	-----	-------	------	-----------	------------

MAIN-P.W.Board			<a href="#">R579</a>	06S15615Y25	RES,RK 101J 1/16 -CP
MAIN-P.W.Board			<a href="#">R580</a>	06S15615Y25	RES,RK 101J 1/16 -CP
MAIN-P.W.Board			<a href="#">R581</a>	06S15615Y59	RES,RK 272J 1/16 -CP
MAIN-P.W.Board			<a href="#">R582</a>	06S15615Y59	RES,RK 272J 1/16 -CP
MAIN-P.W.Board			<a href="#">R583</a>	06S15615Y73	RES,RK 103J 1/16 -CP
MAIN-P.W.Board			<a href="#">R584</a>	06S15615Y25	RES,RK 101J 1/16 -CP
MAIN-P.W.Board			<a href="#">R585</a>	06S15615Y25	RES,RK 101J 1/16 -CP
MAIN-P.W.Board			<a href="#">R586</a>	06S15615Y73	RES,RK 103J 1/16 -CP
MAIN-P.W.Board			<a href="#">R587</a>	06S15615Y73	RES,RK 103J 1/16 -CP
MAIN-P.W.Board			<a href="#">R588</a>	06S15615Y73	RES,RK 103J 1/16 -CP
MAIN-P.W.Board			<a href="#">R589</a>	06S45675W43	RES,RK JUMPER1/10-CP
MAIN-P.W.Board			<a href="#">R590</a>	06S15615Y73	RES,RK 103J 1/16 -CP
MAIN-P.W.Board			<a href="#">R591</a>	06S15593Y49	RES,RK 102F 1/10 -CP
MAIN-P.W.Board			<a href="#">R592</a>	06S15593Y41	RES,RK 471F 1/10 -CP
MAIN-P.W.Board			<a href="#">R593</a>	06S15615Y73	RES,RK 103J 1/16 -CP
MAIN-P.W.Board			<a href="#">R594</a>	06S15615Y73	RES,RK 103J 1/16 -CP
MAIN-P.W.Board			<a href="#">R595</a>	06S15615Y73	RES,RK 103J 1/16 -CP
MAIN-P.W.Board			<a href="#">R596</a>	06S15615Y73	RES,RK 103J 1/16 -CP
MAIN-P.W.Board			<a href="#">R597</a>	06S15615Y81	RES,RK 223J 1/16 -CP
MAIN-P.W.Board			<a href="#">R598</a>	06S15615Y81	RES,RK 223J 1/16 -CP
MAIN-P.W.Board			<a href="#">R599</a>	06S15615Y25	RES,RK 101J 1/16 -CP
MAIN-P.W.Board			<a href="#">R600</a>	06S15615Y89	RES,RK 473J 1/16 -CP
MAIN-P.W.Board			<a href="#">R601</a>	06S15615Y25	RES,RK 101J 1/16 -CP
MAIN-P.W.Board			<a href="#">R602</a>	06S15615Y89	RES,RK 473J 1/16 -CP
MAIN-P.W.Board			<a href="#">R603</a>	06S15615Y89	RES,RK 473J 1/16 -CP
MAIN-P.W.Board			<a href="#">R604</a>	06S15615Y53	RES,RK 152J 1/16 -CP
MAIN-P.W.Board			<a href="#">R605</a>	06S64996F26	RES,RK 105J 1/8 -CP
MAIN-P.W.Board			<a href="#">R606</a>	06S15616Y23	RES,RK JUMPER1/16-CP
MAIN-P.W.Board			<a href="#">R607</a>	06S15616Y23	RES,RK JUMPER1/16-CP
MAIN-P.W.Board			<a href="#">R608</a>	06S15616Y23	RES,RK JUMPER1/16-CP
MAIN-P.W.Board			<a href="#">R610</a>	06S15615Y73	RES,RK 103J 1/16 -CP
MAIN-P.W.Board			<a href="#">R611</a>	06S15615Y73	RES,RK 103J 1/16 -CP
MAIN-P.W.Board			<a href="#">R612</a>	06S15615Y25	RES,RK 101J 1/16 -CP
MAIN-P.W.Board			<a href="#">R613</a>	06S15615Y25	RES,RK 101J 1/16 -CP
MAIN-P.W.Board			<a href="#">R614</a>	06S15615Y73	RES,RK 103J 1/16 -CP
MAIN-P.W.Board			<a href="#">R617</a>	06S45675W43	RES,RK JUMPER1/10-CP
MAIN-P.W.Board			<a href="#">R618</a>	06S15615Y25	RES,RK 101J 1/16 -CP
MAIN-P.W.Board			<a href="#">R620</a>	06S45675W43	RES,RK JUMPER1/10-CP
MAIN-P.W.Board			<a href="#">R621</a>	06S45675W43	RES,RK JUMPER1/10-CP
MAIN-P.W.Board			<a href="#">R622</a>	06S15616Y23	RES,RK JUMPER1/16-CP
MAIN-P.W.Board			<a href="#">R623</a>	06S15615Y25	RES,RK 101J 1/16 -CP

Model Code  
UTE-52BT

NOTE:The part that has not PART NUMBER will not be supplied.

IC501(\*) :51-27561Z01(W25Q32FVSSIG -ST)  
Software is not written in to the part indicated with (\*).

P.W.Board	MIS	MODEL	Ref.	Parts No.	Parts Name
-----------	-----	-------	------	-----------	------------

MAIN-P.W.Board			<a href="#">R624</a>	06S45675W43	RES,RK JUMPER1/10-CP
MAIN-P.W.Board			<a href="#">R625</a>	06S45675W43	RES,RK JUMPER1/10-CP
MAIN-P.W.Board			<a href="#">R626</a>	06S45675W43	RES,RK JUMPER1/10-CP
MAIN-P.W.Board			<a href="#">R627</a>	06S45675W43	RES,RK JUMPER1/10-CP
MAIN-P.W.Board			<a href="#">R633</a>	06S15615Y25	RES,RK 101J 1/16 -CP
MAIN-P.W.Board			<a href="#">R634</a>	06S15616Y23	RES,RK JUMPER1/16-CP
MAIN-P.W.Board			<a href="#">R635</a>	06S15616Y23	RES,RK JUMPER1/16-CP
MAIN-P.W.Board			<a href="#">R636</a>	06S15615Y33	RES,RK 221J 1/16 -CP
MAIN-P.W.Board			<a href="#">R637</a>	06S15616Y23	RES,RK JUMPER1/16-CP
MAIN-P.W.Board			<a href="#">R638</a>	06S15615Y33	RES,RK 221J 1/16 -CP
MAIN-P.W.Board			<a href="#">R639</a>	06S15615Y33	RES,RK 221J 1/16 -CP
MAIN-P.W.Board			<a href="#">R640</a>	06S15616Y23	RES,RK JUMPER1/16-CP
MAIN-P.W.Board			<a href="#">R642</a>	06S15616Y23	RES,RK JUMPER1/16-CP
MAIN-P.W.Board			<a href="#">R643</a>	06S15615Y97	RES,RK 104J 1/16 -CP
MAIN-P.W.Board			<a href="#">R644</a>	06S15615Y25	RES,RK 101J 1/16 -CP
MAIN-P.W.Board			<a href="#">R645</a>	06S15615Y25	RES,RK 101J 1/16 -CP
MAIN-P.W.Board			<a href="#">R646</a>	06S70072F53	RES,CP .102-J-1/4-CP
MAIN-P.W.Board			<a href="#">R647</a>	06S15615Y25	RES,RK 101J 1/16 -CP
MAIN-P.W.Board			<a href="#">R648</a>	06S15615Y25	RES,RK 101J 1/16 -CP
MAIN-P.W.Board			<a href="#">R649</a>	06S15615Y25	RES,RK 101J 1/16 -CP
MAIN-P.W.Board			<a href="#">R650</a>	06S15615Y25	RES,RK 101J 1/16 -CP
MAIN-P.W.Board			<a href="#">R651</a>	06S15615Y25	RES,RK 101J 1/16 -CP
MAIN-P.W.Board			<a href="#">R652</a>	06S15615Y25	RES,RK 101J 1/16 -CP
MAIN-P.W.Board			<a href="#">R653</a>	06S15615Y25	RES,RK 101J 1/16 -CP
MAIN-P.W.Board			<a href="#">R655</a>	06S15616Y23	RES,RK JUMPER1/16-CP
MAIN-P.W.Board			<a href="#">R658</a>	06S15615Y25	RES,RK 101J 1/16 -CP
MAIN-P.W.Board			<a href="#">R659</a>	06S15615Y25	RES,RK 101J 1/16 -CP
MAIN-P.W.Board			<a href="#">R660</a>	06S45674W81	RES,RK 103J 1/10 -CP
MAIN-P.W.Board			<a href="#">R661</a>	06S45674W57	RES,RK 102J 1/10 -CP
MAIN-P.W.Board			<a href="#">R662</a>	06S45674W97	RES,RK 473J 1/10 -CP
MAIN-P.W.Board			<a href="#">R663</a>	06S15615Y33	RES,RK 221J 1/16 -CP
MAIN-P.W.Board			<a href="#">R664</a>	06S15615Y33	RES,RK 221J 1/16 -CP
MAIN-P.W.Board			<a href="#">R665</a>	06S15615Y33	RES,RK 221J 1/16 -CP
MAIN-P.W.Board			<a href="#">R666</a>	06S15615Y33	RES,RK 221J 1/16 -CP
MAIN-P.W.Board			<a href="#">R667</a>	06S15615Y89	RES,RK 473J 1/16 -CP
MAIN-P.W.Board			<a href="#">R724</a>	06S15615Y89	RES,RK 473J 1/16 -CP
MAIN-P.W.Board			<a href="#">R725</a>	06S15615Y89	RES,RK 473J 1/16 -CP
MAIN-P.W.Board			<a href="#">R800</a>	06S45674W81	RES,RK 103J 1/10 -CP
MAIN-P.W.Board			<a href="#">R801</a>	06S45674W81	RES,RK 103J 1/10 -CP
MAIN-P.W.Board			<a href="#">R802</a>	06S15593Y90	RES,RK 513F 1/10 -CP
MAIN-P.W.Board			<a href="#">R803</a>	06-12372Z02	RES,RK R015F 1/5 -CP

Model Code  
UTE-52BT

NOTE:The part that has not PART NUMBER will not be supplied.

IC501(\*) :51-27561Z01(W25Q32FVSSIG -ST)  
Software is not written in to the part indicated with (\*).

P.W.Board	MIS	MODEL	Ref.	Parts No.	Parts Name
-----------	-----	-------	------	-----------	------------

MAIN-P.W.Board			<a href="#">R805</a>	06S15616Y06	RES,RK 224J 1/16 -CP
MAIN-P.W.Board			<a href="#">R806</a>	06S15593Y76	RES,RK 133F 1/10 -CP
MAIN-P.W.Board			<a href="#">R807</a>	06S45675W06	RES,RK 104J 1/10 -CP
MAIN-P.W.Board			<a href="#">R808</a>	06S65415Y51	RES,RK 154F 1/16 -CP
MAIN-P.W.Board			<a href="#">R812</a>	06S15615Y82	RES,RK 243J 1/16 -CP
MAIN-P.W.Board			<a href="#">R813</a>	06S15615Y40	RES,RK 431J 1/16 -CP
MAIN-P.W.Board			<a href="#">R814</a>	06S35084Y47	RES,RK 683F 1/8 -CP
MAIN-P.W.Board			<a href="#">R815</a>	06S65415Y47	RES,RK 683F 1/16 -CP
MAIN-P.W.Board			<a href="#">R816</a>	06S15615Y68	RES,RK 622J 1/16 -CP
MAIN-P.W.Board			<a href="#">R817</a>	06S70072F37	RES,CP .221-J-1/4-CP
MAIN-P.W.Board			<a href="#">R818</a>	06S65415Y34	RES,RK 562F 1/16 -CP
MAIN-P.W.Board			<a href="#">R819</a>	06S65415Y43	RES,RK 333F 1/16 -CP
MAIN-P.W.Board			<a href="#">R820</a>	06S65415Y43	RES,RK 333F 1/16 -CP
MAIN-P.W.Board			<a href="#">R821</a>	06S70072F77	RES,CP .103-J-1/4-CP
MAIN-P.W.Board			<a href="#">R822</a>	06S35083Y41	RES,RK 223F 1/4 -CP
MAIN-P.W.Board			<a href="#">R823</a>	06S15615Y59	RES,RK 272J 1/16 -CP
MAIN-P.W.Board			<a href="#">R824</a>	06S35083Y41	RES,RK 223F 1/4 -CP
MAIN-P.W.Board			<a href="#">R825</a>	06S15593Y77	RES,RK 153F 1/10 -CP
MAIN-P.W.Board			<a href="#">R826</a>	06S35083Y44	RES,RK 393F 1/4 -CP
MAIN-P.W.Board			<a href="#">R827</a>	06S70072F37	RES,CP .221-J-1/4-CP
MAIN-P.W.Board			<a href="#">R829</a>	06S15615Y37	RES,RK 331J 1/16 -CP
MAIN-P.W.Board			<a href="#">R830</a>	06S45674W90	RES,RK 243J 1/10 -CP
MAIN-P.W.Board			<a href="#">R831</a>	06-12372Z02	RES,RK R015F 1/5 -CP
MAIN-P.W.Board			<a href="#">R832</a>	06S15616Y23	RES,RK JUMPER1/16-CP
MAIN-P.W.Board			<a href="#">R833</a>	06S15615Y49	RES,RK 102J 1/16 -CP
MAIN-P.W.Board			<a href="#">R834</a>	06S70072F77	RES,CP .103-J-1/4-CP
MAIN-P.W.Board			<a href="#">R837</a>	06S15615Y58	RES,RK 242J 1/16 -CP
MAIN-P.W.Board			<a href="#">R839</a>	06S15593Y92	RES,RK 623F 1/10 -CP
MAIN-P.W.Board			<a href="#">R841</a>	06S15615Y91	RES,RK 563J 1/16 -CP
MAIN-P.W.Board			<a href="#">R842</a>	06S15616Y12	RES,RK 394J 1/16 -CP
MAIN-P.W.Board			<a href="#">R845</a>	06S35083Y34	RES,RK 562F 1/4 -CP
MAIN-P.W.Board			<a href="#">R846</a>	06S15615Y86	RES,RK 363J 1/16 -CP
MAIN-P.W.Board			<a href="#">R847</a>	06S35083Y45	RES,RK 473F 1/4 -CP
MAIN-P.W.Board			<a href="#">R848</a>	06S70072F69	RES,CP .472-J-1/4-CP
MAIN-P.W.Board			<a href="#">R849</a>	06S15615Y66	RES,RK 512J 1/16 -CP
MAIN-P.W.Board			<a href="#">R850</a>	06S15615Y98	RES,RK 114J 1/16 -CP
MAIN-P.W.Board			<a href="#">R851</a>	06S15615Y66	RES,RK 512J 1/16 -CP
MAIN-P.W.Board			<a href="#">R852</a>	06S15615Y99	RES,RK 124J 1/16 -CP
MAIN-P.W.Board			<a href="#">R854</a>	06S15615Y25	RES,RK 101J 1/16 -CP
MAIN-P.W.Board			<a href="#">R857</a>	06S45674W90	RES,RK 243J 1/10 -CP
MAIN-P.W.Board			<a href="#">R858</a>	06S15615Y72	RES,RK 912J 1/16 -CP

Model Code  
UTE-52BT

NOTE:The part that has not PART NUMBER will not be supplied.

IC501(\*) :51-27561Z01(W25Q32FVSSIG -ST)  
Software is not written in to the part indicated with (\*).



P.W.Board	MIS	MODEL	Ref.	Parts No.	Parts Name
-----------	-----	-------	------	-----------	------------

MAIN-P.W.Board			<a href="#">R859</a>	06S45674W98	RES,RK 513J 1/10 -CP
MAIN-P.W.Board			<a href="#">R861</a>	06S15615Y65	RES,RK 472J 1/16 -CP
MAIN-P.W.Board			<a href="#">R862</a>	06S15616Y01	RES,RK 134J 1/16 -CP
MAIN-P.W.Board			<a href="#">R901</a>	06S15615Y57	RES,RK 222J 1/16 -CP
MAIN-P.W.Board			<a href="#">R902</a>	06S15615Y57	RES,RK 222J 1/16 -CP
MAIN-P.W.Board			<a href="#">R903</a>	06S15615Y25	RES,RK 101J 1/16 -CP
MAIN-P.W.Board			<a href="#">R904</a>	06S15615Y49	RES,RK 102J 1/16 -CP
MAIN-P.W.Board			<a href="#">R905</a>	06S15615Y25	RES,RK 101J 1/16 -CP
MAIN-P.W.Board			<a href="#">R907</a>	06S15615Y25	RES,RK 101J 1/16 -CP
MAIN-P.W.Board			<a href="#">R908</a>	06S15615Y49	RES,RK 102J 1/16 -CP
MAIN-P.W.Board			<a href="#">R909</a>	06S65415Y11	RES,RK 68RF 1/16 -CP
MAIN-P.W.Board			<a href="#">R911</a>	06S45675W30	RES,RK 105J 1/10 -CP
MAIN-P.W.Board			<a href="#">R912</a>	06S45674W89	RES,RK 223J 1/10 -CP
MAIN-P.W.Board			<a href="#">R913</a>	06S70072F29	RES,CP .101-J-1/4-CP
MAIN-P.W.Board			<a href="#">R914</a>	06S15615Y57	RES,RK 222J 1/16 -CP
MAIN-P.W.Board			<a href="#">R915</a>	06S45674W69	RES,RK 332J 1/10 -CP
MAIN-P.W.Board			<a href="#">R916</a>	06S45674W89	RES,RK 223J 1/10 -CP
MAIN-P.W.Board			<a href="#">R917</a>	06S45674W57	RES,RK 102J 1/10 -CP
MAIN-P.W.Board			<a href="#">R919</a>	06S45674W97	RES,RK 473J 1/10 -CP
MAIN-P.W.Board			<a href="#">R920</a>	06S45674W97	RES,RK 473J 1/10 -CP
MAIN-P.W.Board			<a href="#">R921</a>	06S45674W97	RES,RK 473J 1/10 -CP
MAIN-P.W.Board			<a href="#">R922</a>	06S70072F53	RES,CP .102-J-1/4-CP
MAIN-P.W.Board			<a href="#">R923</a>	06S70072F53	RES,CP .102-J-1/4-CP
MAIN-P.W.Board			<a href="#">R924</a>	06S45674W97	RES,RK 473J 1/10 -CP
MAIN-P.W.Board			<a href="#">R925</a>	06S70072F53	RES,CP .102-J-1/4-CP
MAIN-P.W.Board			<a href="#">R926</a>	06S35095Y08	RES,RK JUMPER 1/4-CP
MAIN-P.W.Board			<a href="#">R927</a>	06S35095Y08	RES,RK JUMPER 1/4-CP
MAIN-P.W.Board			<a href="#">R928</a>	06S35095Y08	RES,RK JUMPER 1/4-CP
MAIN-P.W.Board			<a href="#">R933</a>	06S45674W65	RES,RK 222J 1/10 -CP
MAIN-P.W.Board			<a href="#">R934</a>	06S45674W89	RES,RK 223J 1/10 -CP
MAIN-P.W.Board			<a href="#">RA502</a>	06S15771Y13	RES,ARYEXB28V101J-CP
MAIN-P.W.Board			<a href="#">SA101</a>	48-00954Z03	VST,CSA30-401Q-T -CP
MAIN-P.W.Board			<a href="#">SD801</a>	48T45286Y01	DIO,SHT RB050L-40-E1
MAIN-P.W.Board			<a href="#">SF601</a>	91-25003Z01	SAW,B39242B3912U -E1
MAIN-P.W.Board			<a href="#">SW501</a>	40T16096W03	SW ,TACT SKHHLW
MAIN-P.W.Board			<a href="#">T302</a>	25-27983Z01	CHOKE,A090A0201 -DB
MAIN-P.W.Board			<a href="#">VR801</a>	18-12468Z11	VAR,EVM2NSX80 224-CP
MAIN-P.W.Board			<a href="#">VT101</a>	24-03457Z02	COIL,RF FM 5CCE -E6
MAIN-P.W.Board			<a href="#">XL101</a>	91-24701Z06	XTL,DSX321G 62.40-CP
MAIN-P.W.Board			<a href="#">XL502</a>	91-24701Z02	XTL,DSX321G 12.00-CP
MAIN-P.W.Board			<a href="#">XL601</a>	91-26676Z01	XTL,DSX321G 26.00-CP

Model Code  
UTE-52BT

NOTE:The part that has not PART NUMBER will not be supplied.

IC501(\*) :51-27561Z01(W25Q32FVSSIG -ST)  
Software is not written in to the part indicated with (\*).

P.W.Board	MIS	MODEL	Ref.	Parts No.	Parts Name
MAIN-P.W.Board			<a href="#">Z502</a>	91T75196Y01	EMI,BK1005HM102 -CP
MAIN-P.W.Board			<a href="#">Z503</a>	91T15509Y08	EMI,BK1608HM102 -CP
MAIN-P.W.Board			<a href="#">Z504</a>	91T15509Y08	EMI,BK1608HM102 -CP
MAIN-P.W.Board			<a href="#">Z505</a>	91T15509Y08	EMI,BK1608HM102 -CP
MAIN-P.W.Board			<a href="#">Z506</a>	91T15509Y08	EMI,BK1608HM102 -CP
MAIN-P.W.Board			<a href="#">Z507</a>	91T15509Y08	EMI,BK1608HM102 -CP
MAIN-P.W.Board			<a href="#">Z508</a>	91T15509Y08	EMI,BK1608HM102 -CP
MAIN-P.W.Board			<a href="#">Z509</a>	91T75196Y01	EMI,BK1005HM102 -CP
MAIN-P.W.Board			<a href="#">ZD501</a>	48-18196Z02	DIO,ZEN DZ2S051M0LCP
MAIN-P.W.Board			<a href="#">ZD502</a>	48-18196Z02	DIO,ZEN DZ2S051M0LCP
MAIN-P.W.Board			<a href="#">ZD503</a>	48-21149Z19	DIO,ZEN DZ2J051L0LCP
MAIN-P.W.Board			<a href="#">ZD801</a>	48-07043Z37	DIO,ZEN KDZ11V -CP
MAIN-P.W.Board			<a href="#">ZD802</a>	48-21149Z26	DIO,ZEN DZ2J062M0LCP
MAIN-P.W.Board			<a href="#">ZD803</a>	48-01607Z08	DIO,ZEN LUDZ3.9B -CP
MAIN-P.W.Board			<a href="#">ZD901</a>	48-21149Z23	DIO,ZEN DZ2J056M0LCP
MAIN-P.W.Board			<a href="#">ZD902</a>	48-21149Z23	DIO,ZEN DZ2J056M0LCP
MAIN-P.W.Board			<a href="#">ZD903</a>	48-21149Z23	DIO,ZEN DZ2J056M0LCP
FRONT-P.W.Board			<a href="#">C403</a>	08S45676W65	CAP,CER.222K-B1H -CP
FRONT-P.W.Board			<a href="#">C404</a>	08S45232Y07	CAP,CER 222K-B1H -CP
FRONT-P.W.Board			<a href="#">C405</a>	08S45676W65	CAP,CER.222K-B1H -CP
FRONT-P.W.Board			<a href="#">C406</a>	08S45676W85	CAP,CER 104K-B1C -CP
FRONT-P.W.Board			<a href="#">C407</a>	08S45232Y05	CAP,CER 102K-B1H -CP
FRONT-P.W.Board			<a href="#">C408</a>	08S45676W89	CAP,CER 473K-B1E -CP
FRONT-P.W.Board			<a href="#">C409</a>	08S35349Y12	CAP,CER 105K-B0J -CP
FRONT-P.W.Board			<a href="#">C410</a>	08S45676W89	CAP,CER 473K-B1E -CP
FRONT-P.W.Board			<a href="#">C411</a>	08S35374W12	CAP,CER 106K-B0J -CP
FRONT-P.W.Board			<a href="#">C412</a>	08S45676W65	CAP,CER.222K-B1H -CP
FRONT-P.W.Board			<a href="#">C413</a>	08S45676W65	CAP,CER.222K-B1H -CP
FRONT-P.W.Board			<a href="#">CB401</a>	09-18716Z01	BTB,DF20-P -EJ
FRONT-P.W.Board			<a href="#">D401</a>	48-12230Z01	DIO,KDS226-RTK -CP
FRONT-P.W.Board			<a href="#">D402</a>	48-12230Z01	DIO,KDS226-RTK -CP
FRONT-P.W.Board			<a href="#">D403</a>	48-12230Z01	DIO,KDS226-RTK -CP
FRONT-P.W.Board			<a href="#">D406</a>	48-12230Z01	DIO,KDS226-RTK -CP
FRONT-P.W.Board			<a href="#">IC401</a>	51-26843Z01	PT16580-LQ -QT
FRONT-P.W.Board			<a href="#">IC402</a>	51-18623Z01	PNJ4L02M -NE1
FRONT-P.W.Board			<a href="#">JK401</a>	09-27672Z01	JAC,CK-3552 -DB
FRONT-P.W.Board			<a href="#">LCD401</a>	65-26734Z01	LCD,EI0222M0TTN(S)
FRONT-P.W.Board			<a href="#">LD401</a>	48-27378Z01	LED,ARY MDL541-011DB
FRONT-P.W.Board			<a href="#">LD402</a>	48-15702Z01	LED,BLU SCM015BC7TCP
FRONT-P.W.Board			<a href="#">LD404</a>	48-15702Z01	LED,BLU SCM015BC7TCP
FRONT-P.W.Board			<a href="#">LD405</a>	48-15702Z01	LED,BLU SCM015BC7TCP

Model Code  
UTE-52BT

NOTE:The part that has not PART NUMBER will not be supplied.

IC501(\*) :51-27561Z01(W25Q32FVSSIG -ST)  
Software is not written in to the part indicated with (\*).



P.W.Board	MIS	MODEL	Ref.	Parts No.	Parts Name
-----------	-----	-------	------	-----------	------------

FRONT-P.W.Board			<a href="#">LD406</a>	48-15702Z01	LED,BLU SCM015BC7TCP
FRONT-P.W.Board			<a href="#">LD409</a>	48-15702Z01	LED,BLU SCM015BC7TCP
FRONT-P.W.Board			<a href="#">LD410</a>	48-15702Z01	LED,BLU SCM015BC7TCP
FRONT-P.W.Board			<a href="#">LD411</a>	48-15702Z01	LED,BLU SCM015BC7TCP
FRONT-P.W.Board			<a href="#">LD412</a>	48-15702Z01	LED,BLU SCM015BC7TCP
FRONT-P.W.Board			<a href="#">LD413</a>	48-15702Z01	LED,BLU SCM015BC7TCP
FRONT-P.W.Board			<a href="#">LD414</a>	48-15702Z01	LED,BLU SCM015BC7TCP
FRONT-P.W.Board			<a href="#">LD415</a>	48-15702Z01	LED,BLU SCM015BC7TCP
FRONT-P.W.Board			<a href="#">LD416</a>	48-15702Z01	LED,BLU SCM015BC7TCP
FRONT-P.W.Board			<a href="#">LD417</a>	48-15702Z01	LED,BLU SCM015BC7TCP
FRONT-P.W.Board			<a href="#">LD418</a>	48-15702Z01	LED,BLU SCM015BC7TCP
FRONT-P.W.Board			<a href="#">LD419</a>	48-15702Z01	LED,BLU SCM015BC7TCP
FRONT-P.W.Board			<a href="#">LD420</a>	48-15702Z01	LED,BLU SCM015BC7TCP
FRONT-P.W.Board			<a href="#">LD421</a>	48-15702Z01	LED,BLU SCM015BC7TCP
FRONT-P.W.Board			<a href="#">Q405</a>	48-13059Z01	TR,KTC2875-B-RTK -CP
FRONT-P.W.Board			<a href="#">Q411</a>	48-21758Z01	TR,DSC2001S0L -CP
FRONT-P.W.Board			<a href="#">R401</a>	06S64995F53	RES,RK 102J 1/8 -CP
FRONT-P.W.Board			<a href="#">R405</a>	06S70072F62	RES,CP .242-J-1/4-CP
FRONT-P.W.Board			<a href="#">R406</a>	06S64995F53	RES,RK 102J 1/8 -CP
FRONT-P.W.Board			<a href="#">R407</a>	06S64995F53	RES,RK 102J 1/8 -CP
FRONT-P.W.Board			<a href="#">R409</a>	06S64995F53	RES,RK 102J 1/8 -CP
FRONT-P.W.Board			<a href="#">R410</a>	06S64995F53	RES,RK 102J 1/8 -CP
FRONT-P.W.Board			<a href="#">R413</a>	06S64995F53	RES,RK 102J 1/8 -CP
FRONT-P.W.Board			<a href="#">R419</a>	06S70072F40	RES,CP .301-J-1/4-CP
FRONT-P.W.Board			<a href="#">R421</a>	06S70072F49	RES,CP .681-J-1/4-CP
FRONT-P.W.Board			<a href="#">R427</a>	06S15616Y23	RES,RK JUMPER1/16-CP
FRONT-P.W.Board			<a href="#">R428</a>	06S65415Y25	RES,RK 102F 1/16 -CP
FRONT-P.W.Board			<a href="#">R431</a>	06S65415Y25	RES,RK 102F 1/16 -CP
FRONT-P.W.Board			<a href="#">R432</a>	06S35084Y39	RES,RK 153F 1/8 -CP
FRONT-P.W.Board			<a href="#">R433</a>	06S65415Y25	RES,RK 102F 1/16 -CP
FRONT-P.W.Board			<a href="#">R434</a>	06S35084Y78	RES,RK 132F 1/8 -CP
FRONT-P.W.Board			<a href="#">R435</a>	06S35084Y39	RES,RK 153F 1/8 -CP
FRONT-P.W.Board			<a href="#">R436</a>	06S35084Y44	RES,RK 393F 1/8 -CP
FRONT-P.W.Board			<a href="#">R437</a>	06S35084Y78	RES,RK 132F 1/8 -CP
FRONT-P.W.Board			<a href="#">R438</a>	06S35084Y28	RES,RK 182F 1/8 -CP
FRONT-P.W.Board			<a href="#">R439</a>	06S35084Y31	RES,RK 332F 1/8 -CP
FRONT-P.W.Board			<a href="#">R440</a>	06S35084Y29	RES,RK 222F 1/8 -CP
FRONT-P.W.Board			<a href="#">R441</a>	06S35084Y64	RES,RK 432F 1/8 -CP
FRONT-P.W.Board			<a href="#">R442</a>	06S35084Y68	RES,RK 752F 1/8 -CP
FRONT-P.W.Board			<a href="#">R445</a>	06S35084Y44	RES,RK 393F 1/8 -CP
FRONT-P.W.Board			<a href="#">R446</a>	06S45674W73	RES,RK 472J 1/10 -CP

Model Code  
UTE-52BT

NOTE:The part that has not PART NUMBER will not be supplied.

IC501(\*) :51-27561Z01(W25Q32FVSSIG -ST)  
Software is not written in to the part indicated with (\*).

P.W.Board	MIS	MODEL	Ref.	Parts No.	Parts Name
FRONT-P.W.Board			<a href="#">R448</a>	06S70072F44	RES,CP .431-J-1/4-CP
FRONT-P.W.Board			<a href="#">R449</a>	06S70072F55	RES,CP .122-J-1/4-CP
FRONT-P.W.Board			<a href="#">R450</a>	06S70072F53	RES,CP .102-J-1/4-CP
FRONT-P.W.Board			<a href="#">R451</a>	06S70072F53	RES,CP .102-J-1/4-CP
FRONT-P.W.Board			<a href="#">R452</a>	06S70072F53	RES,CP .102-J-1/4-CP
FRONT-P.W.Board			<a href="#">R453</a>	06S70072F50	RES,CP .751-J-1/4-CP
FRONT-P.W.Board			<a href="#">R455</a>	06S35084Y28	RES,RK 182F 1/8 -CP
FRONT-P.W.Board			<a href="#">R456</a>	06S35084Y31	RES,RK 332F 1/8 -CP
FRONT-P.W.Board			<a href="#">R457</a>	06S35084Y29	RES,RK 222F 1/8 -CP
FRONT-P.W.Board			<a href="#">R458</a>	06S35084Y64	RES,RK 432F 1/8 -CP
FRONT-P.W.Board			<a href="#">R459</a>	06S35084Y68	RES,RK 752F 1/8 -CP
FRONT-P.W.Board			<a href="#">R461</a>	06S70072F29	RES,CP .101-J-1/4-CP
FRONT-P.W.Board			<a href="#">R463</a>	06S70072F47	RES,CP .561-J-1/4-CP
FRONT-P.W.Board			<a href="#">R469</a>	06S70072F53	RES,CP .102-J-1/4-CP
FRONT-P.W.Board			<a href="#">R470</a>	06S45674W58	RES,RK 112J 1/10 -CP
FRONT-P.W.Board			<a href="#">R483</a>	06S70072F44	RES,CP .431-J-1/4-CP
FRONT-P.W.Board			<a href="#">RA401</a>	06S15771Y13	RES,ARYEXB28V101J-CP
FRONT-P.W.Board			<a href="#">SK401</a>	09-19382Z01	SKT,CM-V105 -DB
FRONT-P.W.Board			<a href="#">SW401</a>	40T65353Y01	SW,TACT SKRSPACE010E2
FRONT-P.W.Board			<a href="#">SW403</a>	40T65353Y01	SW,TACT SKRSPACE010E2
FRONT-P.W.Board			<a href="#">SW404</a>	40T65353Y01	SW,TACT SKRSPACE010E2
FRONT-P.W.Board			<a href="#">SW405</a>	40T65353Y01	SW,TACT SKRSPACE010E2
FRONT-P.W.Board			<a href="#">SW406</a>	40T65353Y01	SW,TACT SKRSPACE010E2
FRONT-P.W.Board			<a href="#">SW407</a>	40T65353Y01	SW,TACT SKRSPACE010E2
FRONT-P.W.Board			<a href="#">SW408</a>	40T65353Y01	SW,TACT SKRSPACE010E2
FRONT-P.W.Board			<a href="#">SW409</a>	40T65353Y01	SW,TACT SKRSPACE010E2
FRONT-P.W.Board			<a href="#">SW410</a>	40T65353Y01	SW,TACT SKRSPACE010E2
FRONT-P.W.Board			<a href="#">SW411</a>	40T65353Y01	SW,TACT SKRSPACE010E2
FRONT-P.W.Board			<a href="#">SW412</a>	40-10735Z02	ENC,EC12D1524405 -DB
FRONT-P.W.Board			<a href="#">SW413</a>	40T65353Y01	SW,TACT SKRSPACE010E2
FRONT-P.W.Board			<a href="#">SW414</a>	40T65353Y01	SW,TACT SKRSPACE010E2
FRONT-P.W.Board			<a href="#">SW415</a>	40T65353Y01	SW,TACT SKRSPACE010E2
FRONT-P.W.Board			<a href="#">SW416</a>	40T65353Y01	SW,TACT SKRSPACE010E2
FRONT-P.W.Board			<a href="#">SW417</a>	40T65353Y01	SW,TACT SKRSPACE010E2
FRONT-P.W.Board			<a href="#">SW418</a>	40T65353Y01	SW,TACT SKRSPACE010E2
FRONT-P.W.Board			<a href="#">Z401</a>	91-14147Z01	EMI,ACM2012H-900 -CP
FRONT-P.W.Board			<a href="#">ZD401</a>	48-18196Z02	DIO,ZEN DZ2S051M0LCP
FRONT-P.W.Board			<a href="#">ZD402</a>	48-18196Z02	DIO,ZEN DZ2S051M0LCP

Model Code  
UTE-52BT

NOTE:The part that has not PART NUMBER will not be supplied.

IC501(\*) :51-27561Z01(W25Q32FVSSIG -ST)  
Software is not written in to the part indicated with (\*).