

## Packing Assembly Parts List

Model Code  
iLX-507(RL00035A)

Note: This Service Manual contains only construction parts of the unit.

Not all construction parts are repair parts and can be used for repairs.

For repair parts ask our local service partner.

MODEL	Symbol No.	Parts No.	Parts Name	The number of use	Packing View
	102	03S60820Y17	SCR,MCH 5X8 ZN A	*4	
	103	03S60820Y16	SCR,MCH 5X8 ZN A	*4	
	104	07-43393Z01	BKT,HDMI ASSY	*1	
	112	09-43394Z01	ASSY,ANID-2079-01A	*1	
	113	85-34947Z03	ASSY,YOP-5270AL04	*1	
	114	09-18014Z01	ASSY,ANID-0125-01A	*1	
	115	09-43397Z01	ASSY,ANID-2077-01A	*1	
	116	09-43398Z01	ASSY,ANID-2078-01A	*1	
	117	09-17244Z18	ASSY,ANIC-0050-18A	*1	
	118	50-14386Z04	ASSY,LYS-M9750-FUL	*1	
	122	QRG,21DA AOAM	*1		

# Parts Identification

(FRONT View)

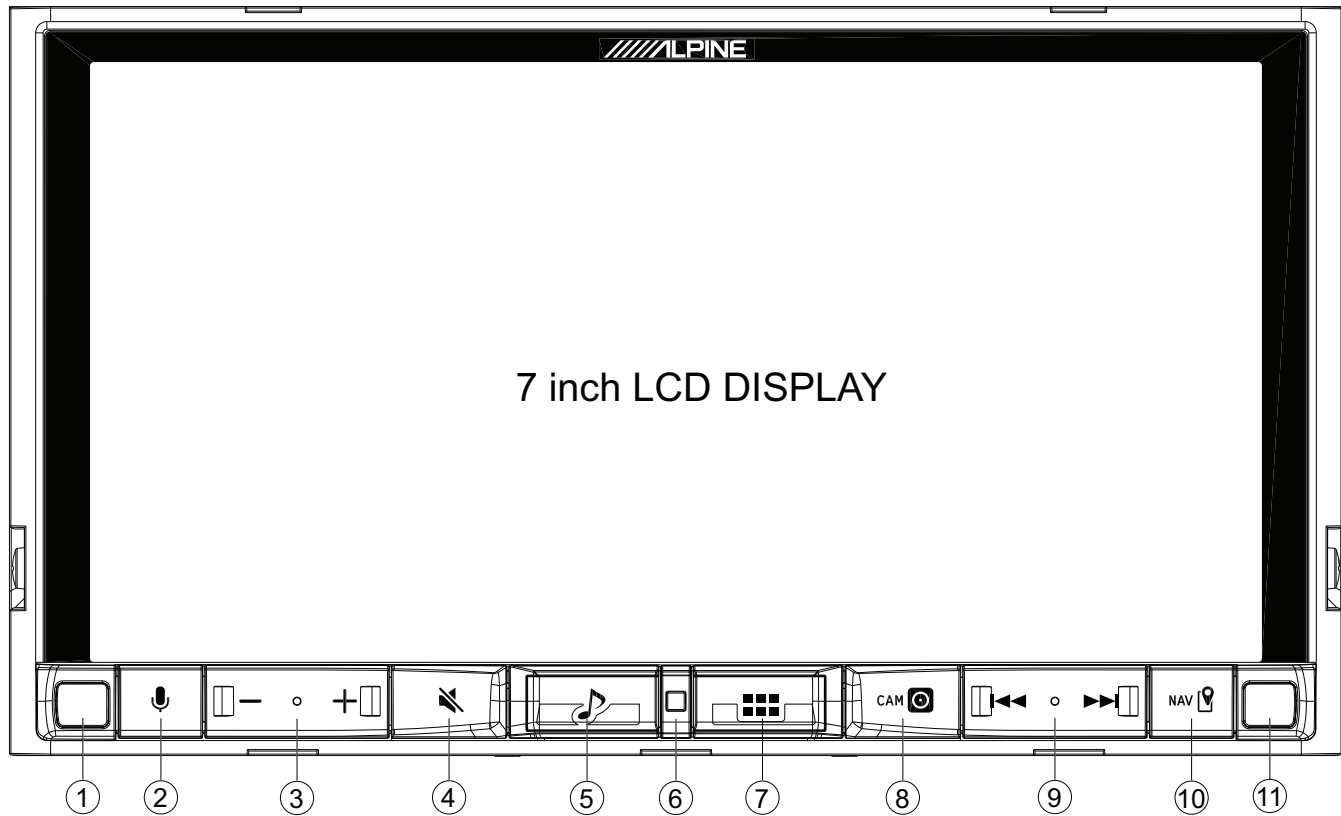

- |                     |                          |
|---------------------|--------------------------|
| ① Dimmer Sensor     | ⑦  (HOME) Button         |
| ②  (MIC) Button     | ⑧  (CAM) Button          |
| ③  (DOWN/UP) Button | ⑨  (Seek up/down) Button |
| ④  (MUTE) Button    | ⑩  (MAP) Button          |
| ⑤  (Audio) Button   | ⑪ Remote Sensor          |
| ⑥ Power Indicator   |                          |

(REAR View)

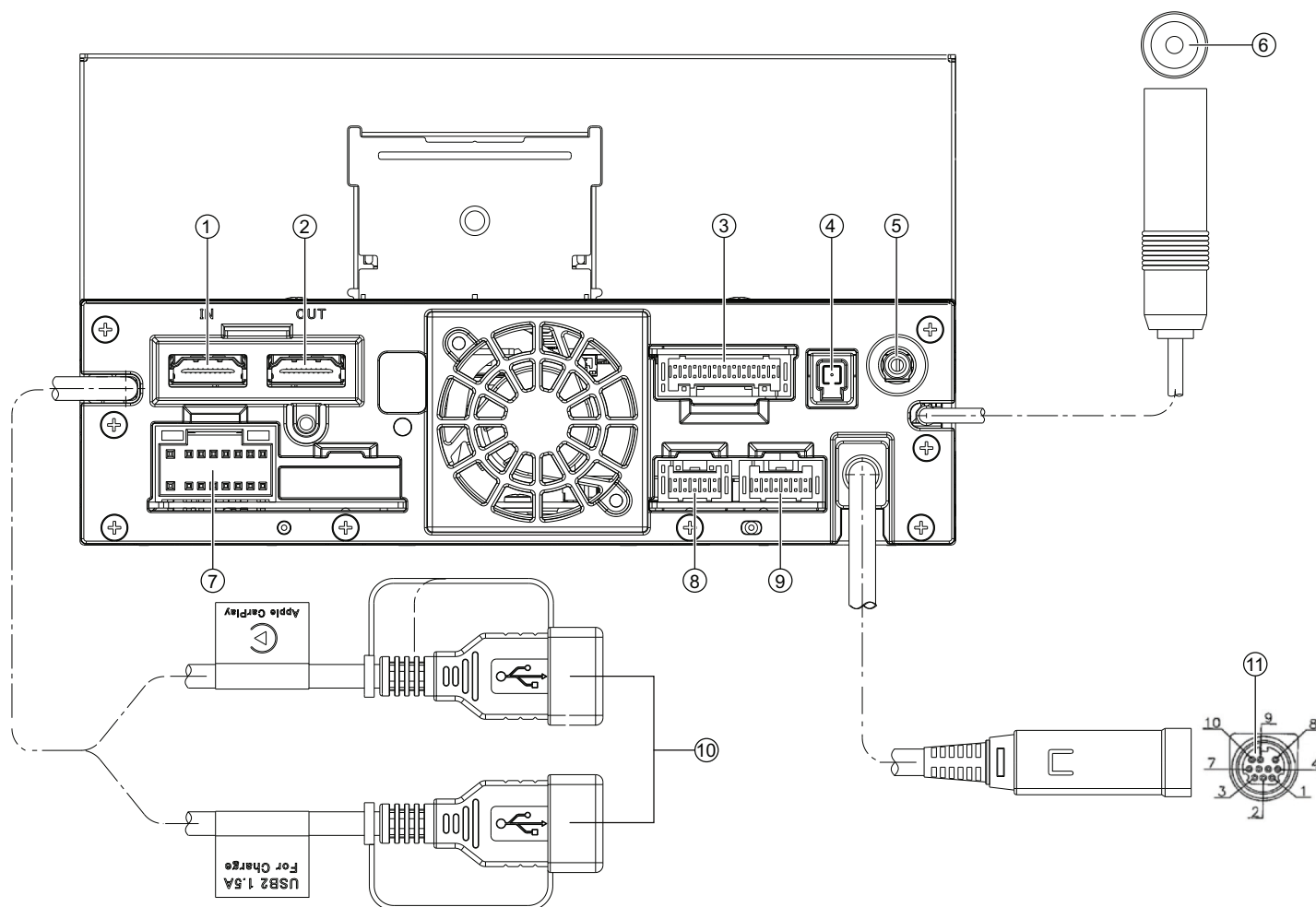

- ① \*CB4400(HDMI IN CONNECTOR : SOC-P.W.Board)  
WTB,TCX3400-011187-T (09-25213Z01)
- ② \*CB4600(HDMI OUT CONNECTOR : SOC-P.W.Board)  
WTB,TCX3400-011187-T (09-25213Z01)

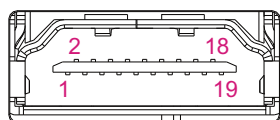

①	TMDS Data2+	⑪	TMDS Clock Shield
②	TMDS Data2 Shield	⑫	TMDS Clock-
③	TMDS Data2-	⑬	NC(CEC)
④	TMDS Data1+	⑭	NC (Utility)
⑤	TMDS Data1 Shield	⑮	SCL
⑥	TMDS Data1-	⑯	SDA
⑦	TMDS Data0+	⑰	F_GND_2
⑧	TMDS Data0 Shield	⑱	+5V Power
⑨	TMDS Data0-	⑲	Hot Plug Detect
⑩	TMDS Clock+		

- ③ \*CB6000(CAMERA CONNECTOR : SOC-P.W.Board)  
WTB,SM22B-PUDK-D -EK (09-38369Z03)

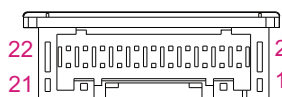

①	FCAM-VGND	⑫	LIN
②	RCAM-VIN	⑬	F_GND_3
③	FCAM-VIN	⑭	A53-UART-GND
④	RCAM-VGND	⑮	CAM1_6V
⑤	FCAM-UART	⑯	CAN-RX-IN
⑥	RCAM-UART	⑰	VSP-IN
⑦	EXT-CANH	⑱	CAN-TX-OUT
⑧	EXT-CANL	⑲	A53-UART-HRX
⑨	AUX2-VGND	⑳	A53-UART-HTX
⑩	LIN-GND	㉑	CAN-BATT
⑪	AUX2-VIN	㉒	CAN-GND

- ④ \*ANT4000(GPS ANT : SOC-P.W.Board)  
GT21T-1P-H -EE (09-36702Z01)

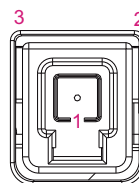

①	GPS-ANT
②	GND
③	GND

- ⑤ \*JK4800(AUX IN CONNECTOR : SOC-P.W.Board)  
JAC,HSJ1765-011075EA (09-12459Z01)

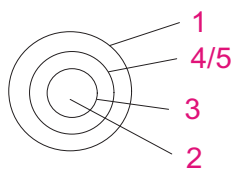

①	AUX_VS
②	AUX_L
③	AUX_R
④	AUX_SGND
⑤	AUX_VGND

- ⑥ \*ANT1(RADIO ANT)  
ASSY,ASAA-1086-39A(09-39981Z01)

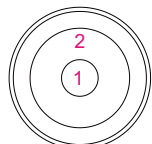

①	RF-IN
②	GND

- ⑦ \*CB2700(POWER CONNECTOR: MAIN-P.W.Board)  
WTB,2515WR-16P-B -T (09-39556Z01)

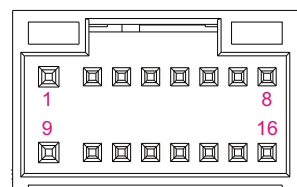

①	BATT	⑨	GND
②	RL-	⑩	FL-
③	RL+	⑪	FL+
④	RR-	⑫	FR-
⑤	RR+	⑬	FR+
⑥	PARKING	⑭	REVERSE
⑦	O-REM	⑮	REVERSE
⑧	P-ANT	⑯	ACC

- ⑧ \*CB2703(PRE OUT CONNECTOR : MAIN-P.W.Board)  
WTB,SM10B-PUDK-D -EU (09-38369Z01)

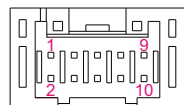

①	Pre-Out_FL	⑥	S_GND
②	S_GND	⑦	Pre-Out_RR
③	Pre-Out_RL	⑧	S_GND
④	S_GND	⑨	Pre-Out_SWR
⑤	Pre-Out_FR	⑩	Pre-Out-SWL

- ⑨ \*CB2701(REMOTE CONNECTOR : MAIN-P.W.Board)  
WTB,SM12B-PUDK-D -EG (09-38369Z05)

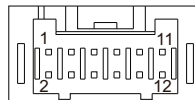

①	ST-REM-IN	⑦	ST-DIRECT-2
②	ST_REM5V	⑧	ST-DIRECT-3
③	GND	⑨	GND
④	AUX-REM-IN	⑩	AUX-REM-OUT
⑤	HDMI-REM-OUT	⑪	EX-MIC+
⑥	ST-DIRECT-1	⑫	EX-MIC-

- ⑩ \*CH1(USB)  
ASSY,ANID-2082-01A(09-44184Z01)

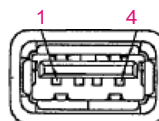

①	VBUS
②	D-
③	D+
④	GND

- ⑪ \*ANT2(SXM ANT)  
ASSY,ANID-0139-02A(09-19615Z02)

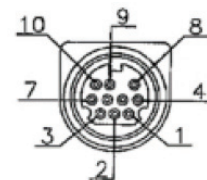

①	AUDIO_L	⑥	POWER_EN
②	GND_A	⑦	POWER
③	AUDIO_R	⑧	POWER
④	RXD	⑨	GND_D
⑤	TXD	⑩	GND_D

## Exploded View Parts List (Display Unit)

Model Code

iLX-507(RL00035A)

Note: This Service Manual contains only construction parts of the unit.

Not all construction parts are repair parts and can be used for repairs.

For repair parts ask our local service partner.

Model	Symbol No.	Parts No.	Parts Name	pcs
	10	15-29983Z02	COVER,FPC	*1
	61	13-42873Z01	NOSE,MONITOR	*1
	62	14-24373Z36	INS,CVR 160X2XT0.4	*2
	63	14-24373Z37	INS,CVR 86X2XT0.4	*2
	64	EN-42879Z05	NOSE,KEY ASSY	*1
	65	15-40765Z04	COVER,PWB KEY	*1
	66	14-28478Z17	INS,CVR 15X4XT0.16	*1
	67	07-43318Z01	BKT,LCD	*1
	68	07-43317Z01	BKT,MONITOR	*1
	71	30-15488Z37	SML2CD-30X36.51-ADX6	*1
	900	SU-45183Z01	SU_DISP_RL00035A	*1
	901	SU-45522Z01	SU_NOSE_RL00035A	*1
	902	SU-45194Z01	SU_KEY_RL00035A	*1
	ET1	HCDSP0K019C	ASSY,HCDSP0K019C	*1
	LCD1	65-38780Z01	ASSY,COG-ALPI7002-02	*1



## Exploded View Parts List (B-BOX Unit)

Model Code

iLX-507(RL00035A)

Note: This Service Manual contains only construction parts of the unit.

Not all construction parts are repair parts and can be used for repairs.

For repair parts ask our local service partner.

Model	Symbol No.	Parts No.	Parts Name	pcs
	1	27-43319Z01	CHAS,BASE ASSY	*1
	2	07-43386Z01	BKT,FRONT	*1
	3	15-43321Z01	COVER, TOP ASSY	*1
	4	14-44077Z01	INS,CVR TOP	*1
	5	15-29982Z02	COVER,PLATE TOP	*1
	6	03S60822Y13	SCR,S-T 2.6X6 ZN A	*14
	7	03S60822Y10	SCR,S-T 2.6X5 ZN A	*2
	8	03S60822Y23	SCR,S-T 2.6X16 ZN A	*2
	9	07-43324Z02	BKT,REAR	*1
	17	42-35537Z02	CLAMP RLSC-1V0	*1
	18	75-40862Z01	TMS-43-30 7-7HC	*3
	19	84-44200Z01	FPC,21GDA_SOC-DISP	*1
	20	42-44735Z01	CLAMP,CC-1002NH	*1
	25	03S60822Y18	SCR,S-T 2.6X8 ZN A	*10
	800	SU-49636Z01	SU_MAIN_RL00035A_4G	*1
	801	SU-49637Z01	SU_MAIN_RL00035A_2G	*1
	802	SU-49638Z01	SU_SOC_RL00035A_4G	*1
	803	SU-49639Z01	SU_SOC_RL00035A_2G	*1
	ANT1	09-39981Z01	ASSY,ASAA-1086-39A	*1
	ANT2	09-19615Z02	ASSY,ANID-0139-02A	*1
	CH1	09-44184Z01	ASSY,ANID-2082-01A	*1
	CH2	09-24492Z07	ASSY,U.FL-2LPHF6N2	*1
	M1	59-33274Z02	MOTOR,LF40A05PAP15A	*1

### Exploded View\_B-BOX Unit (1/4)

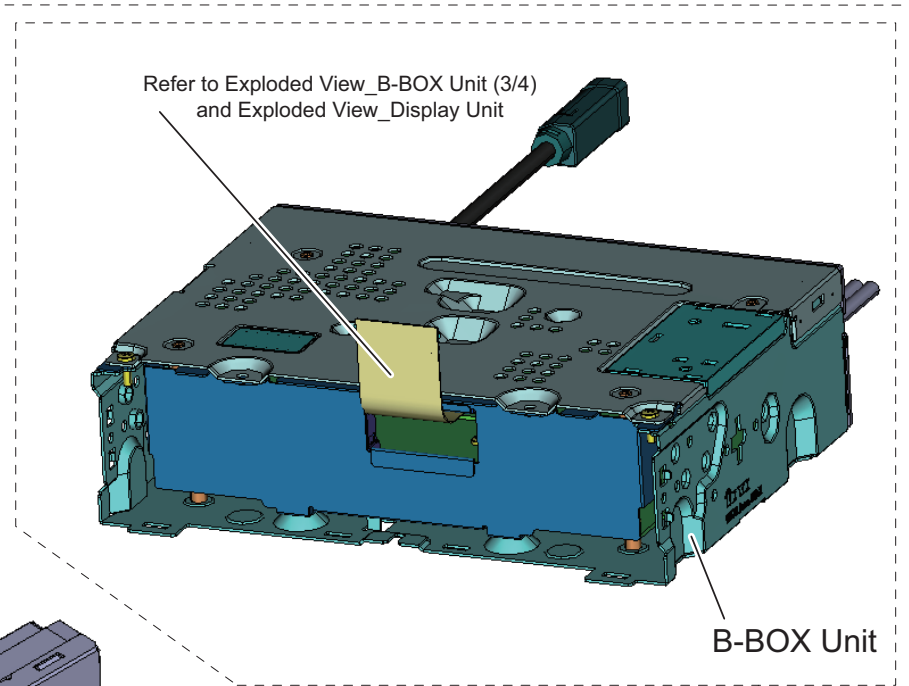
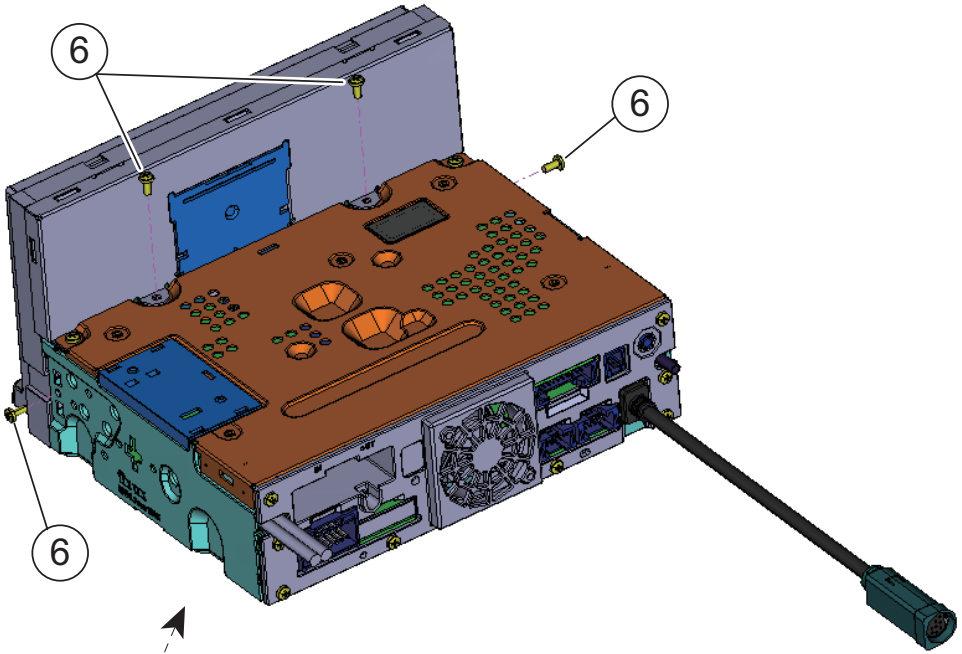

Refer to Exploded View\_B-BOX Unit (3/4) and Exploded View\_Display Unit

B-BOX Unit

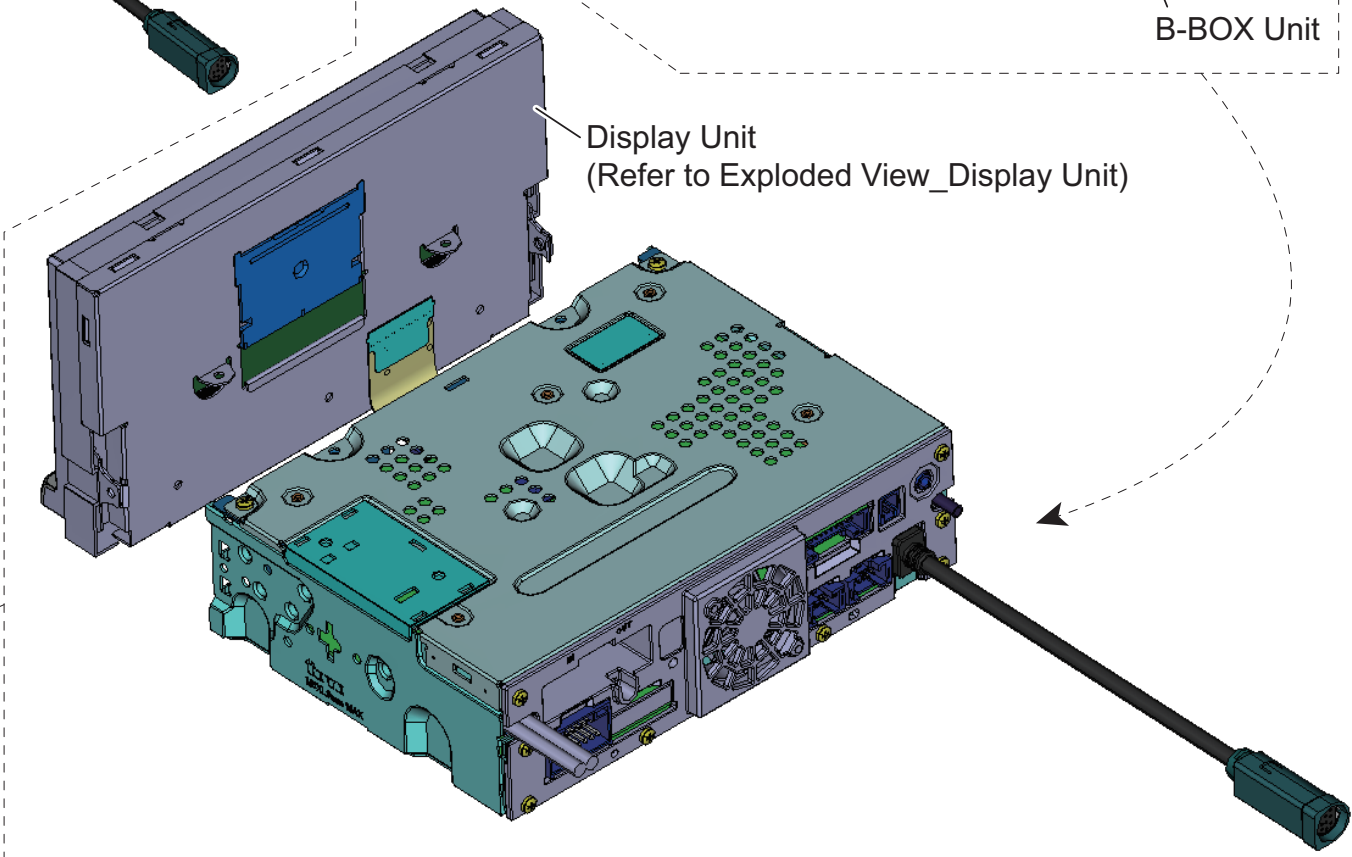

Display Unit  
(Refer to Exploded View\_Display Unit)

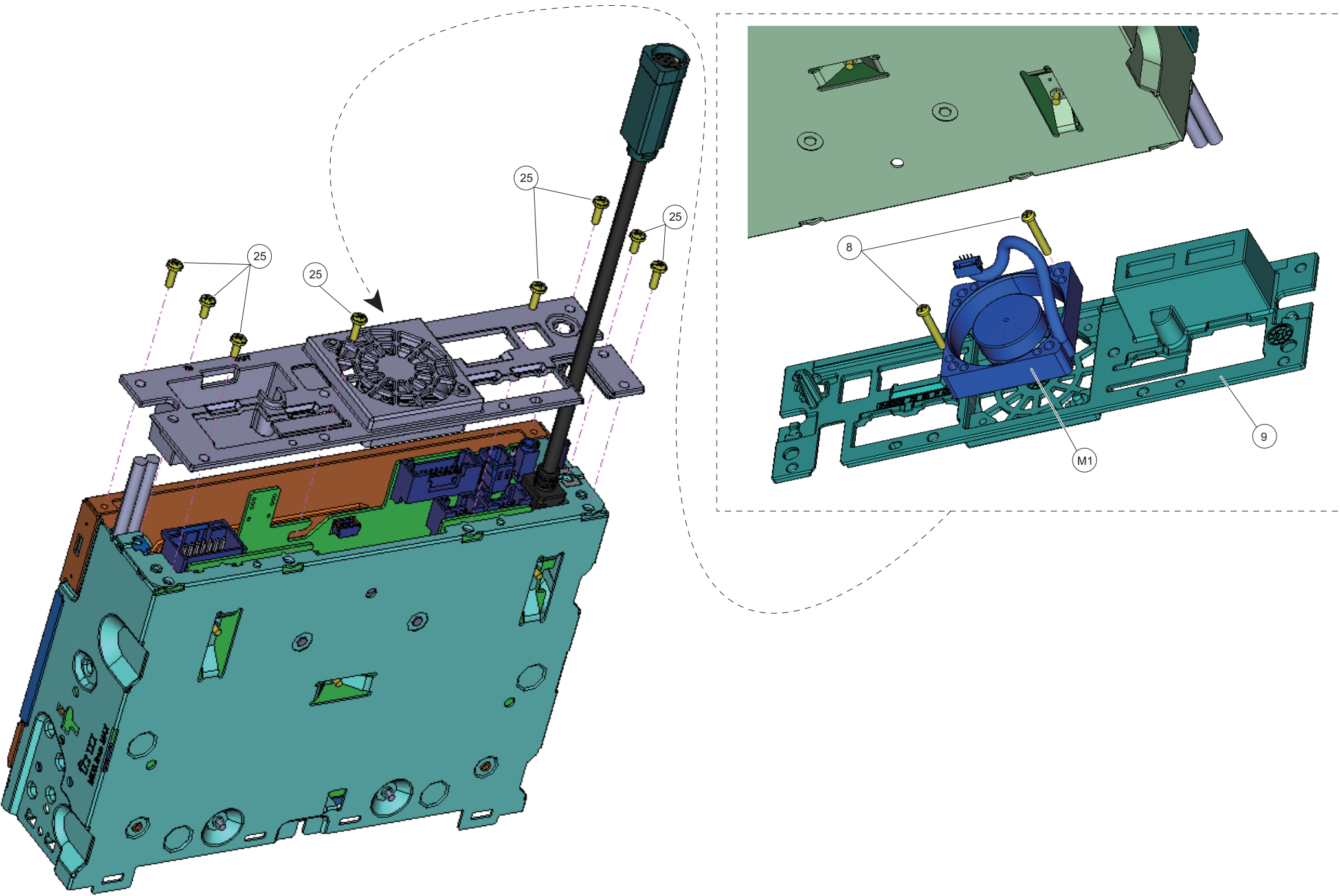

Exploded View\_B-BOX Unit (3/4)

[Click! Return To The Page Of Contents](#)

Confidential

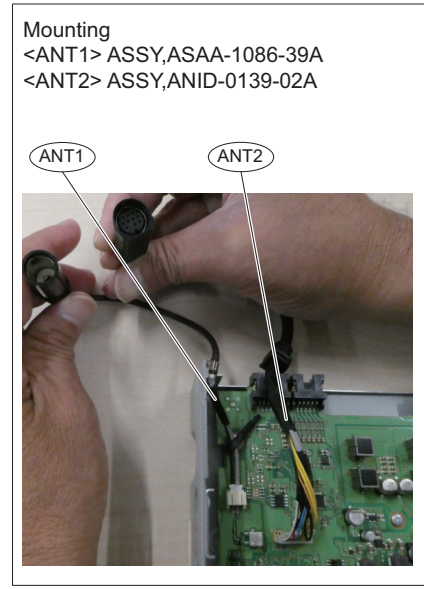
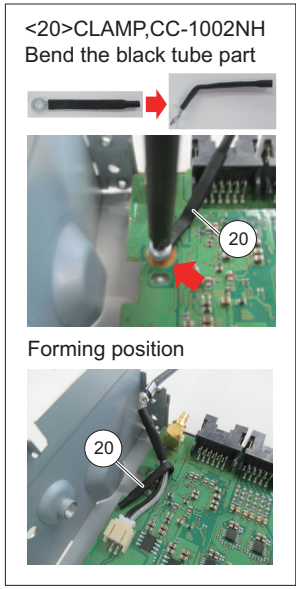
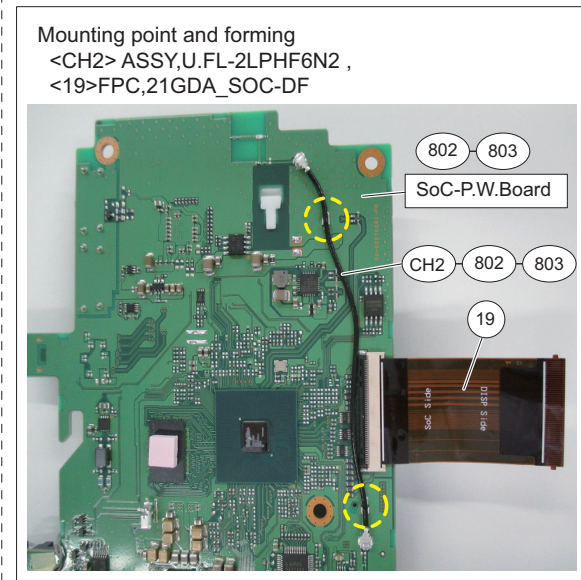
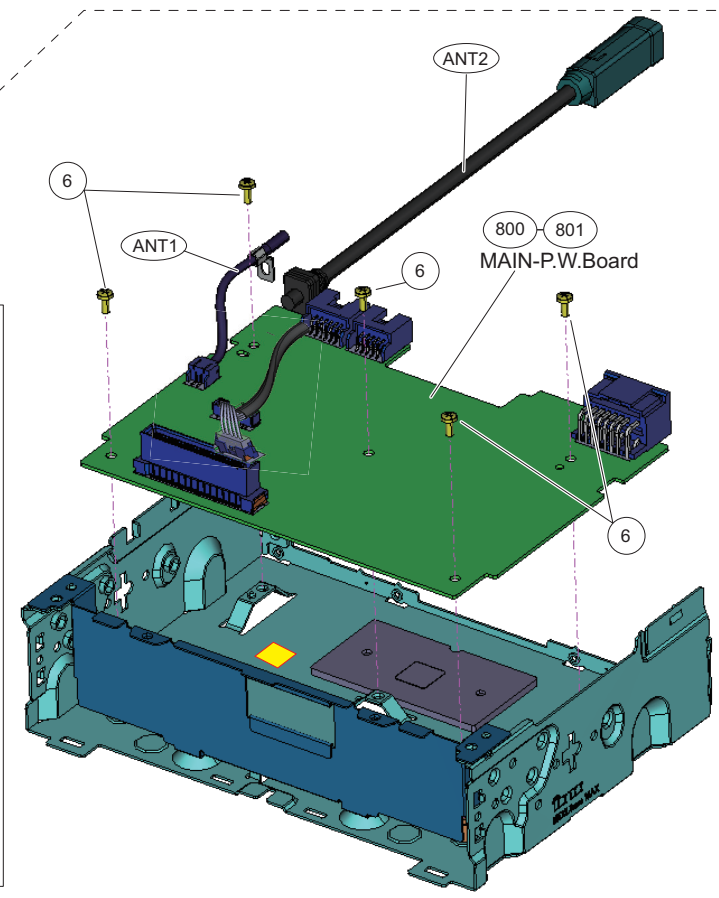
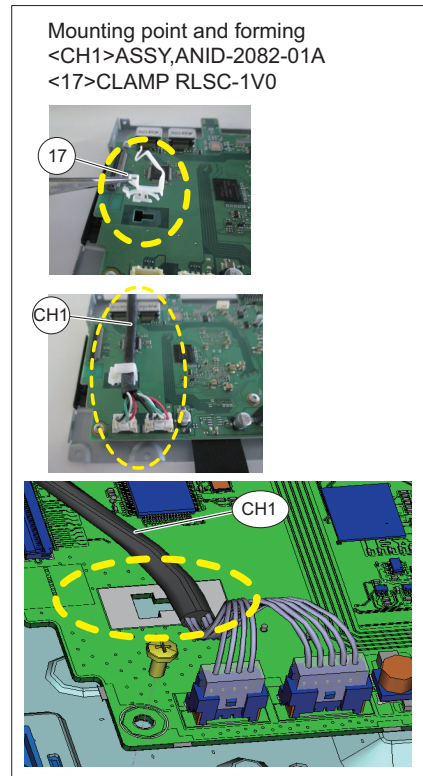
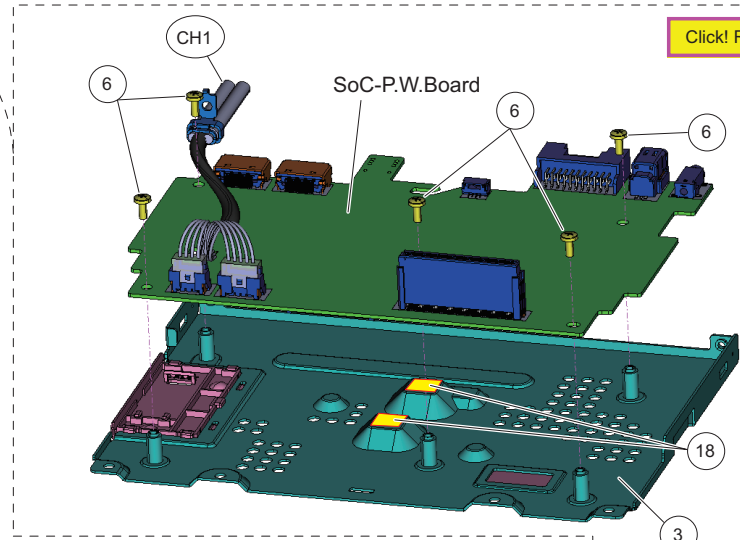
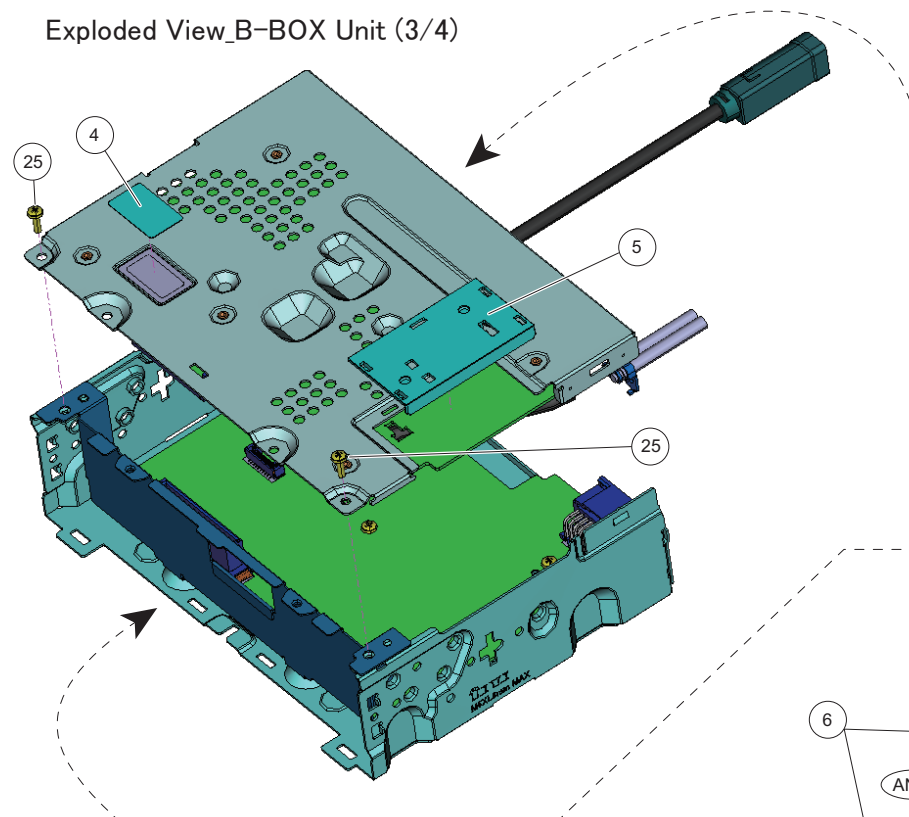

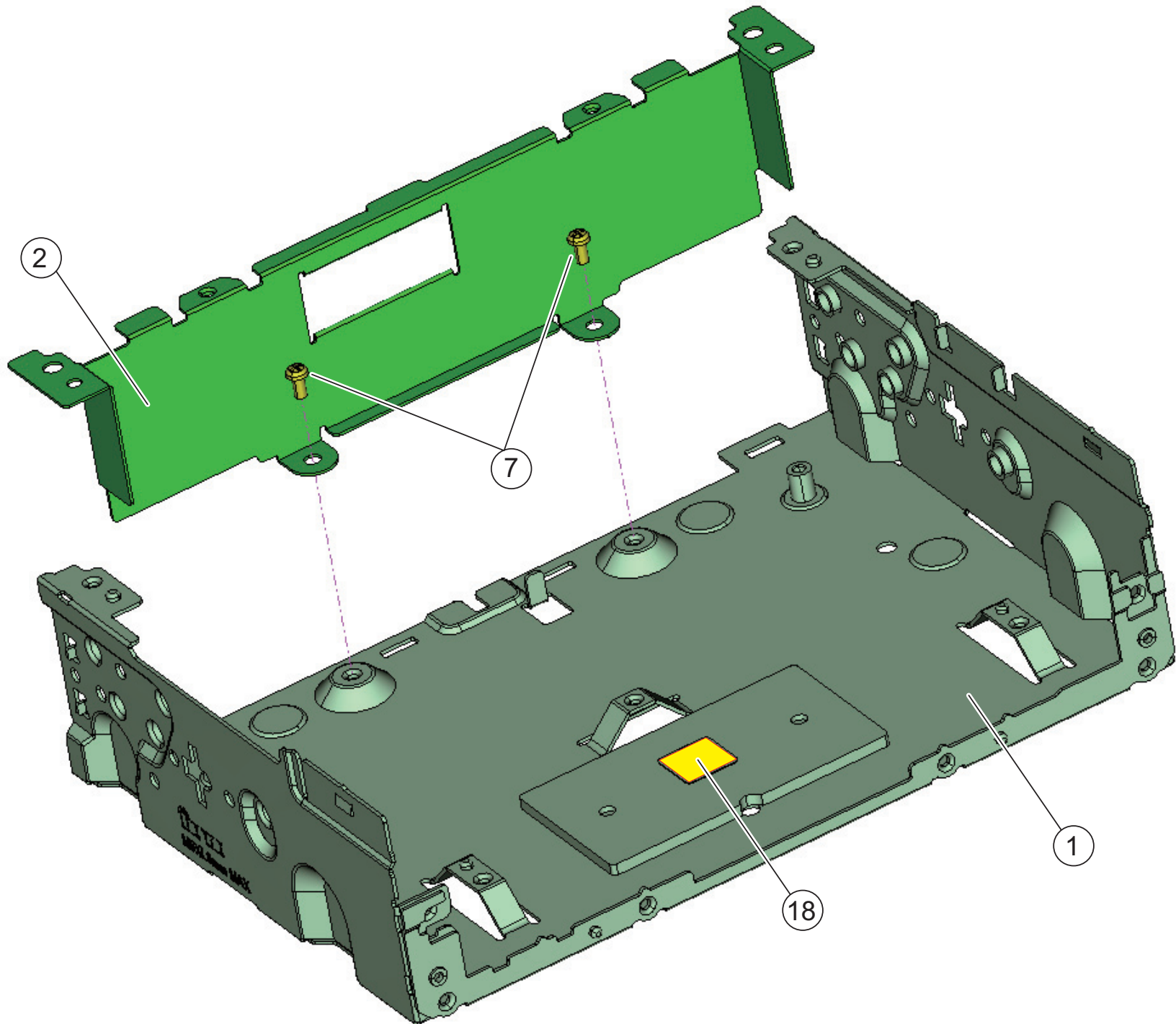

## Electrical Parts List

Model Code

iLX-507(RL00035A)

Note: This Service Manual contains only construction parts of the unit.

Not all construction parts are repair parts and can be used for repairs.

For repair parts ask our local service partner.

IC2001(\*) :51-38431Z01(W25Q80DVSNAQ -ST)

IC3820(\*) :51-42249Z01(W25Q64JVSSBQ -ST)

IC3840(\*) :51-34725Z02(H26M41208HPRN -BT)

IC7500(\*) :51-38306Z01(CYAT81682-100AA61-QT)

Software is not written in to the part indicated with (\*).

P.W.Board	MIS	MODEL	Ref.	Parts No.	Parts Name
MAIN-P.W.Board			C1000	08-32827Z14	CAP,CER 15RJCG1HQ2CP
MAIN-P.W.Board			C1001	08-32827Z12	CAP,CER 10RJCG1HQ2CP
MAIN-P.W.Board			C1002	08-32827Z12	CAP,CER 10RJCG1HQ2CP
MAIN-P.W.Board			C1003	08-32827Z12	CAP,CER 10RJCG1HQ2CP
MAIN-P.W.Board			C1004	08-32827Z12	CAP,CER 10RJCG1HQ2CP
MAIN-P.W.Board			C1005	08-32827Z12	CAP,CER 10RJCG1HQ2CP
MAIN-P.W.Board			C1006	08-38014Z05	CAP,CER 225KX5R1A-CP
MAIN-P.W.Board			C1007	08-32878Z05	CAP,CER105KX7R1AQ2CP
MAIN-P.W.Board			C1010	08-37526Z13	CAP,CER 8R0D-CG1H-CP
MAIN-P.W.Board			C1011	08-37526Z15	CAP,CER 10RJ-CG1H-CP
MAIN-P.W.Board			C1012	08-32877Z11	CAP,CER 224MX7R1H-CP
MAIN-P.W.Board			C1013	08-32877Z04	CAP,CER106KX7R0JQ2CP
MAIN-P.W.Board			C1014	08-37800Z09	CAP,CER 224KX5R1A-CP
MAIN-P.W.Board			C1015	08-32877Z04	CAP,CER106KX7R0JQ2CP
MAIN-P.W.Board			C1016	08-37800Z09	CAP,CER 224KX5R1A-CP
MAIN-P.W.Board			C1017	08-32877Z04	CAP,CER106KX7R0JQ2CP
MAIN-P.W.Board			C1018	08-37800Z09	CAP,CER 224KX5R1A-CP
MAIN-P.W.Board			C1019	08-32877Z11	CAP,CER 224MX7R1H-CP
MAIN-P.W.Board			C1020	08-32877Z04	CAP,CER106KX7R0JQ2CP
MAIN-P.W.Board			C1021	08-37800Z09	CAP,CER 224KX5R1A-CP
MAIN-P.W.Board			C1022	08-32877Z04	CAP,CER106KX7R0JQ2CP
MAIN-P.W.Board			C1023	08-37800Z09	CAP,CER 224KX5R1A-CP
MAIN-P.W.Board			C1024	08-32827Z12	CAP,CER 10RJCG1HQ2CP
MAIN-P.W.Board			C1025	08-32877Z04	CAP,CER106KX7R0JQ2CP
MAIN-P.W.Board			C1026	08-37800Z09	CAP,CER 224KX5R1A-CP
MAIN-P.W.Board			C1027	08-32877Z07	CAP,CER 225KX7R1A-CP
MAIN-P.W.Board			C1028	08-32877Z07	CAP,CER 225KX7R1A-CP
MAIN-P.W.Board			C1029	08-32878Z05	CAP,CER105KX7R1AQ2CP
MAIN-P.W.Board			C1030	08-32827Z04	CAP,CER 3R0CCG1HQ2CP
MAIN-P.W.Board			C1031	08-32827Z15	CAP,CER 22RJCG1HQ2CP
MAIN-P.W.Board			C1032	08-32877Z11	CAP,CER 224MX7R1H-CP
MAIN-P.W.Board			C1033	08-34782Z05	CAP,CER 475KX5R1A-CP
MAIN-P.W.Board			C1034	08-32877Z11	CAP,CER 224MX7R1H-CP
MAIN-P.W.Board			C1035	08-32827Z14	CAP,CER 15RJCG1HQ2CP
MAIN-P.W.Board			C1037	08-32827Z12	CAP,CER 10RJCG1HQ2CP
MAIN-P.W.Board			C1039	08-32827Z12	CAP,CER 10RJCG1HQ2CP
MAIN-P.W.Board			C1040	08-32827Z12	CAP,CER 10RJCG1HQ2CP
MAIN-P.W.Board			C1041	08-32827Z04	CAP,CER 3R0CCG1HQ2CP
MAIN-P.W.Board			C1042	08-32878Z05	CAP,CER105KX7R1AQ2CP
MAIN-P.W.Board			C1043	08-32878Z05	CAP,CER105KX7R1AQ2CP
MAIN-P.W.Board			C1044	08-32827Z15	CAP,CER 22RJCG1HQ2CP
MAIN-P.W.Board			C1045	08-34782Z10	CAP,CER 225KX5R1E-CP
MAIN-P.W.Board			C1046	08-34782Z10	CAP,CER 225KX5R1E-CP
MAIN-P.W.Board			C1047	08-34782Z10	CAP,CER 225KX5R1E-CP
MAIN-P.W.Board			C1048	08-34782Z10	CAP,CER 225KX5R1E-CP
MAIN-P.W.Board			C1051	08-32827Z29	CAP,CER 391JCG1HQ2CP
MAIN-P.W.Board			C1052	08-32827Z29	CAP,CER 391JCG1HQ2CP
MAIN-P.W.Board			C1053	08-38014Z05	CAP,CER 225KX5R1A-CP
MAIN-P.W.Board			C1054	08-38014Z05	CAP,CER 225KX5R1A-CP
MAIN-P.W.Board			C1055	08-38014Z05	CAP,CER 225KX5R1A-CP
MAIN-P.W.Board			C1056	08-32827Z12	CAP,CER 10RJCG1HQ2CP
MAIN-P.W.Board			C1402	08-37793Z24	CAP,CER 104KX5R1A-CP
MAIN-P.W.Board			C1404	08-32877Z08	CAP,CER 106KX7R1A-CP
MAIN-P.W.Board			C1405	08-37800Z09	CAP,CER 224KX5R1A-CP
MAIN-P.W.Board			C1406	08-38014Z05	CAP,CER 225KX5R1A-CP
MAIN-P.W.Board			C1408	08-32877Z08	CAP,CER 106KX7R1A-CP
MAIN-P.W.Board			C1409	08-37800Z09	CAP,CER 224KX5R1A-CP
MAIN-P.W.Board			C1410	08-32871Z10	CAP,CER104KX7R1CQ2CP
MAIN-P.W.Board			C1411	08-32877Z08	CAP,CER 106KX7R1A-CP
MAIN-P.W.Board			C1412	08-38014Z05	CAP,CER 225KX5R1A-CP
MAIN-P.W.Board			C1413	08-32827Z29	CAP,CER 391JCG1HQ2CP
MAIN-P.W.Board			C1414	08-32827Z29	CAP,CER 391JCG1HQ2CP
MAIN-P.W.Board			C1450	08-32827Z12	CAP,CER 10RJCG1HQ2CP
MAIN-P.W.Board			C1451	08-34782Z08	CAP,CER 475KX5R1C-CP
MAIN-P.W.Board			C1452	08-32827Z12	CAP,CER 10RJCG1HQ2CP
MAIN-P.W.Board			C1453	08-34782Z08	CAP,CER 475KX5R1C-CP

P.W.Board	MIS	MODEL	Ref.	Parts No.	Parts Name
MAIN-P.W.Board			C1454	08-32877Z11	CAP,CER 224MX7R1H-CP
MAIN-P.W.Board			C1455	08-32877Z11	CAP,CER 224MX7R1H-CP
MAIN-P.W.Board			C1456	08-37526Z29	CAP,CER 2R7C-CG1H-CP
MAIN-P.W.Board			C1457	08-32827Z15	CAP,CER 22RJCG1HQ2CP
MAIN-P.W.Board			C1458	08-32877Z02	CAP,CER225KX7R1CQ2CP
MAIN-P.W.Board			C1459	08-32827Z23	CAP,CER 101JCG1HQ2CP
MAIN-P.W.Board			C1460	08-32827Z15	CAP,CER 22RJCG1HQ2CP
MAIN-P.W.Board			C1461	08-32933Z01	CAP,TF 155K-1C -CP
MAIN-P.W.Board			C1462	08-37526Z29	CAP,CER 2R7C-CG1H-CP
MAIN-P.W.Board			C1463	08-32827Z15	CAP,CER 22RJCG1HQ2CP
MAIN-P.W.Board			C1464	08-32877Z02	CAP,CER225KX7R1CQ2CP
MAIN-P.W.Board			C1465	08-32827Z23	CAP,CER 101JCG1HQ2CP
MAIN-P.W.Board			C1466	08-32827Z15	CAP,CER 22RJCG1HQ2CP
MAIN-P.W.Board			C1467	08-32933Z01	CAP,TF 155K-1C -CP
MAIN-P.W.Board			C1468	08-32877Z11	CAP,CER 224MX7R1H-CP
MAIN-P.W.Board			C1469	08-37526Z29	CAP,CER 2R7C-CG1H-CP
MAIN-P.W.Board			C1470	08-32827Z15	CAP,CER 22RJCG1HQ2CP
MAIN-P.W.Board			C1471	08-32877Z02	CAP,CER225KX7R1CQ2CP
MAIN-P.W.Board			C1472	08-32827Z23	CAP,CER 101JCG1HQ2CP
MAIN-P.W.Board			C1473	08-32827Z15	CAP,CER 22RJCG1HQ2CP
MAIN-P.W.Board			C1474	08-32933Z01	CAP,TF 155K-1C -CP
MAIN-P.W.Board			C1475	08-37526Z29	CAP,CER 2R7C-CG1H-CP
MAIN-P.W.Board			C1476	08-32827Z15	CAP,CER 22RJCG1HQ2CP
MAIN-P.W.Board			C1477	08-32877Z02	CAP,CER225KX7R1CQ2CP
MAIN-P.W.Board			C1478	08-32827Z23	CAP,CER 101JCG1HQ2CP
MAIN-P.W.Board			C1479	08-32827Z15	CAP,CER 22RJCG1HQ2CP
MAIN-P.W.Board			C1480	08-32933Z01	CAP,TF 155K-1C -CP
MAIN-P.W.Board			C1481	08-32877Z11	CAP,CER 224MX7R1H-CP
MAIN-P.W.Board			C1482	08-32877Z11	CAP,CER 224MX7R1H-CP
MAIN-P.W.Board			C1483	08-32877Z11	CAP,CER 224MX7R1H-CP
MAIN-P.W.Board			C1650	08-34782Z10	CAP,CER 225KX5R1E-CP
MAIN-P.W.Board			C1651	08-34782Z10	CAP,CER 225KX5R1E-CP
MAIN-P.W.Board			C1652	08-34782Z10	CAP,CER 225KX5R1E-CP
MAIN-P.W.Board			C1653	08-34782Z10	CAP,CER 225KX5R1E-CP
MAIN-P.W.Board			C1654	08-34782Z10	CAP,CER 225KX5R1E-CP
MAIN-P.W.Board			C1655	08-34782Z10	CAP,CER 225KX5R1E-CP
MAIN-P.W.Board			C1700	08-32878Z03	CAP,CER104KX7R1HQ2CP
MAIN-P.W.Board			C1701	08-32861Z07	CAP,CER 225KX7R1H-CP
MAIN-P.W.Board			C1702	08-32877Z11	CAP,CER 224MX7R1H-CP
MAIN-P.W.Board			C1703	08-32861Z01	CAP,CER475KX7R1CQ2CP
MAIN-P.W.Board			C1704	08-32877Z11	CAP,CER 224MX7R1H-CP
MAIN-P.W.Board			C1705	08-32877Z12	CAP,CER 105KX7R1H-CP
MAIN-P.W.Board			C1706	08-32871Z09	CAP,CER103KX7R1HQ2CP
MAIN-P.W.Board			C1707	08-32877Z11	CAP,CER 224MX7R1H-CP
MAIN-P.W.Board			C1708	08-32827Z30	CAP,CER 471JCG1HQ2CP
MAIN-P.W.Board			C1709	08-32827Z30	CAP,CER 471JCG1HQ2CP
MAIN-P.W.Board			C1710	08-32827Z30	CAP,CER 471JCG1HQ2CP
MAIN-P.W.Board			C1711	08-32827Z30	CAP,CER 471JCG1HQ2CP
MAIN-P.W.Board			C1712	08-32827Z30	CAP,CER 471JCG1HQ2CP
MAIN-P.W.Board			C1713	08-32827Z30	CAP,CER 471JCG1HQ2CP
MAIN-P.W.Board			C1714	08-32827Z30	CAP,CER 471JCG1HQ2CP
MAIN-P.W.Board			C1715	08-32827Z30	CAP,CER 471JCG1HQ2CP
MAIN-P.W.Board			C1716	08-38338Z01	CAP,TF 225K-1E -CP
MAIN-P.W.Board			C1717	08-38338Z01	CAP,TF 225K-1E -CP
MAIN-P.W.Board			C1718	08-38338Z01	CAP,TF 225K-1E -CP
MAIN-P.W.Board			C1719	08-38338Z01	CAP,TF 225K-1E -CP
MAIN-P.W.Board			C1720	08-32878Z03	CAP,CER104KX7R1HQ2CP
MAIN-P.W.Board			C1721	08-32878Z03	CAP,CER104KX7R1HQ2CP
MAIN-P.W.Board			C1722	08-32878Z03	CAP,CER104KX7R1HQ2CP
MAIN-P.W.Board			C1723	08-38338Z01	CAP,TF 225K-1E -CP
MAIN-P.W.Board			C1724	08-38338Z01	CAP,TF 225K-1E -CP
MAIN-P.W.Board			C1725	08-38338Z01	CAP,TF 225K-1E -CP
MAIN-P.W.Board			C1726	08-38338Z01	CAP,TF 225K-1E -CP
MAIN-P.W.Board			C1727	08-32878Z03	CAP,CER104KX7R1HQ2CP
MAIN-P.W.Board			C1728	08-32878Z03	CAP,CER104KX7R1HQ2CP
MAIN-P.W.Board			C1729	08-32878Z03	CAP,CER104KX7R1HQ2CP
MAIN-P.W.Board			C1730	08-32878Z03	CAP,CER104KX7R1HQ2CP
MAIN-P.W.Board			C1731	08-32877Z11	CAP,CER 224MX7R1H-CP
MAIN-P.W.Board			C1733	08-32878Z03	CAP,CER104KX7R1HQ2CP
MAIN-P.W.Board			C1735	08-32877Z12	CAP,CER 105KX7R1H-CP
MAIN-P.W.Board			C1736	08-32877Z12	CAP,CER 105KX7R1H-CP
MAIN-P.W.Board			C1737	08-32877Z12	CAP,CER 105KX7R1H-CP
MAIN-P.W.Board			C1738	08-32877Z12	CAP,CER 105KX7R1H-CP
MAIN-P.W.Board			C1739	08-32877Z12	CAP,CER 105KX7R1H-CP
MAIN-P.W.Board			C1740	08-32877Z12	CAP,CER 105KX7R1H-CP
MAIN-P.W.Board			C1741	08-32877Z12	CAP,CER 105KX7R1H-CP
MAIN-P.W.Board			C1742	08-32878Z03	CAP,CER104KX7R1HQ2CP
MAIN-P.W.Board			C1743	08-32861Z01	CAP,CER475KX7R1CQ2CP

P.W.Board	MIS	MODEL	Ref.	Parts No.	Parts Name
MAIN-P.W.Board			C1744	08-32827Z33	CAP,CER 102JCG1HQ2CP
MAIN-P.W.Board			C1745	08-32827Z23	CAP,CER 101JCG1HQ2CP
MAIN-P.W.Board			C1800	08-32827Z20	CAP,CER 56RJCG1HQ2CP
MAIN-P.W.Board			C1801	08-32827Z20	CAP,CER 56RJCG1HQ2CP
MAIN-P.W.Board			C1803	08-37526Z18	CAP,CER 18RJ-CG1H-CP
MAIN-P.W.Board			C1804	08-32827Z33	CAP,CER 102JCG1HQ2CP
MAIN-P.W.Board			C1805	08-32871Z20	CAP,CER 224KX7R1A-CP
MAIN-P.W.Board			C1806	08-32871Z04	CAP,CER332KX7R1HQ2CP
MAIN-P.W.Board			C1807	08-37793Z24	CAP,CER 104KX5R1A-CP
MAIN-P.W.Board			C1808	08-32877Z04	CAP,CER106KX7R0JQ2CP
MAIN-P.W.Board			C1809	08-37793Z24	CAP,CER 104KX5R1A-CP
MAIN-P.W.Board			C1810	08-37793Z24	CAP,CER 104KX5R1A-CP
MAIN-P.W.Board			C1811	08-37793Z24	CAP,CER 104KX5R1A-CP
MAIN-P.W.Board			C1812	08-37793Z24	CAP,CER 104KX5R1A-CP
MAIN-P.W.Board			C1813	08-32827Z33	CAP,CER 102JCG1HQ2CP
MAIN-P.W.Board			C1814	08-32871Z07	CAP,CER103KX7R1CQ2CP
MAIN-P.W.Board			C1815	08-32860Z05	CAP,CER 222JCG1HQ2CP
MAIN-P.W.Board			C1816	08-32871Z07	CAP,CER103KX7R1CQ2CP
MAIN-P.W.Board			C1817	08-37793Z24	CAP,CER 104KX5R1A-CP
MAIN-P.W.Board			C1818	08-37793Z24	CAP,CER 104KX5R1A-CP
MAIN-P.W.Board			C1819	08-32871Z04	CAP,CER332KX7R1HQ2CP
MAIN-P.W.Board			C1820	08-37793Z24	CAP,CER 104KX5R1A-CP
MAIN-P.W.Board			C1821	08-37526Z15	CAP,CER 10RJ-CG1H-CP
MAIN-P.W.Board			C1822	08-37793Z24	CAP,CER 104KX5R1A-CP
MAIN-P.W.Board			C1823	08-37526Z15	CAP,CER 10RJ-CG1H-CP
MAIN-P.W.Board			C1824	08-32827Z33	CAP,CER 102JCG1HQ2CP
MAIN-P.W.Board			C1826	08-37793Z24	CAP,CER 104KX5R1A-CP
MAIN-P.W.Board			C1827	08-37793Z24	CAP,CER 104KX5R1A-CP
MAIN-P.W.Board			C1828	08-37793Z24	CAP,CER 104KX5R1A-CP
MAIN-P.W.Board			C1829	08-37793Z24	CAP,CER 104KX5R1A-CP
MAIN-P.W.Board			C1830	08-37793Z24	CAP,CER 104KX5R1A-CP
MAIN-P.W.Board			C1831	08-32878Z05	CAP,CER105KX7R1AQ2CP
MAIN-P.W.Board			C1832	08-32877Z03	CAP,CER475KX7R1AQ2CP
MAIN-P.W.Board			C1833	08-37793Z24	CAP,CER 104KX5R1A-CP
MAIN-P.W.Board			C1834	08-37793Z24	CAP,CER 104KX5R1A-CP
MAIN-P.W.Board			C1835	08-37793Z24	CAP,CER 104KX5R1A-CP
MAIN-P.W.Board			C1836	08-37793Z24	CAP,CER 104KX5R1A-CP
MAIN-P.W.Board			C1837	08-37793Z24	CAP,CER 104KX5R1A-CP
MAIN-P.W.Board			C1838	08-37793Z24	CAP,CER 104KX5R1A-CP
MAIN-P.W.Board			C1839	08-37793Z24	CAP,CER 104KX5R1A-CP
MAIN-P.W.Board			C1840	08-37793Z24	CAP,CER 104KX5R1A-CP
MAIN-P.W.Board			C1841	08-37793Z24	CAP,CER 104KX5R1A-CP
MAIN-P.W.Board			C1842	08-32827Z28	CAP,CER 331JCG1HQ2CP
MAIN-P.W.Board			C1843	08-32827Z28	CAP,CER 331JCG1HQ2CP
MAIN-P.W.Board			C1845	08-39096Z04	CAP,CER 103KX7R2A-CP
MAIN-P.W.Board			C1846	08-32827Z14	CAP,CER 15RJCG1HQ2CP
MAIN-P.W.Board			C1847	08-32871Z01	CAP,CER102KX7R1HQ2CP
MAIN-P.W.Board			C1848	08-32827Z04	CAP,CER 3R0CCG1HQ2CP
MAIN-P.W.Board			C1849	08-32827Z14	CAP,CER 15RJCG1HQ2CP
MAIN-P.W.Board			C1850	08-32827Z19	CAP,CER 47RJCG1HQ2CP
MAIN-P.W.Board			C1851	08-32827Z02	CAP,CER 1R5CCG1HQ2CP
MAIN-P.W.Board			C1852	08-32827Z33	CAP,CER 102JCG1HQ2CP
MAIN-P.W.Board			C1854	08-32827Z22	CAP,CER 82RJCG1HQ2CP
MAIN-P.W.Board			C1855	08-32877Z06	CAP,CER 475KX7R0J-CP
MAIN-P.W.Board			C1857	08-37793Z24	CAP,CER 104KX5R1A-CP
MAIN-P.W.Board			C1858	08-37793Z24	CAP,CER 104KX5R1A-CP
MAIN-P.W.Board			C1860	08-37793Z24	CAP,CER 104KX5R1A-CP
MAIN-P.W.Board			C1861	08-32871Z19	CAP,CER 104KX7R1A-CP
MAIN-P.W.Board			C1864	08-32827Z12	CAP,CER 10RJCG1HQ2CP
MAIN-P.W.Board			C2002	08-32877Z04	CAP,CER106KX7R0JQ2CP
MAIN-P.W.Board			C2003	08-32877Z04	CAP,CER106KX7R0JQ2CP
MAIN-P.W.Board			C2004	08-32827Z23	CAP,CER 101JCG1HQ2CP
MAIN-P.W.Board			C2005	08-32877Z06	CAP,CER 475KX7R0J-CP
MAIN-P.W.Board			C2006	08-32877Z04	CAP,CER106KX7R0JQ2CP
MAIN-P.W.Board			C2021	08-37793Z24	CAP,CER 104KX5R1A-CP
MAIN-P.W.Board			C2022	08-37793Z24	CAP,CER 104KX5R1A-CP
MAIN-P.W.Board			C2023	08-37793Z24	CAP,CER 104KX5R1A-CP
MAIN-P.W.Board			C2024	08-37793Z24	CAP,CER 104KX5R1A-CP
MAIN-P.W.Board			C2025	08-37793Z24	CAP,CER 104KX5R1A-CP
MAIN-P.W.Board			C2026	08-37793Z24	CAP,CER 104KX5R1A-CP
MAIN-P.W.Board			C2027	08-32878Z05	CAP,CER105KX7R1AQ2CP
MAIN-P.W.Board			C2030	08-37793Z24	CAP,CER 104KX5R1A-CP
MAIN-P.W.Board			C2033	08-32871Z10	CAP,CER104KX7R1CQ2CP
MAIN-P.W.Board			C2034	08-32877Z04	CAP,CER106KX7R0JQ2CP
MAIN-P.W.Board			C2035	08-32877Z04	CAP,CER106KX7R0JQ2CP
MAIN-P.W.Board			C2036	08-32877Z04	CAP,CER106KX7R0JQ2CP
MAIN-P.W.Board			C2051	08-32877Z04	CAP,CER106KX7R0JQ2CP
MAIN-P.W.Board			C2200	08-32878Z03	CAP,CER104KX7R1HQ2CP

P.W.Board	MIS	MODEL	Ref.	Parts No.	Parts Name
MAIN-P.W.Board			C2201	08-37972Z07	CAP,CER 106KX7R1H-CP
MAIN-P.W.Board			C2202	08-32877Z11	CAP,CER 224MX7R1H-CP
MAIN-P.W.Board			C2203	08-37972Z07	CAP,CER 106KX7R1H-CP
MAIN-P.W.Board			C2204	08-32877Z08	CAP,CER 106KX7R1A-CP
MAIN-P.W.Board			C2207	08-37972Z03	CAP,CER 226KX7R1C-CP
MAIN-P.W.Board			C2208	08-32877Z11	CAP,CER 224MX7R1H-CP
MAIN-P.W.Board			C2220	08-32878Z03	CAP,CER104KX7R1HQ2CP
MAIN-P.W.Board			C2221	08-37972Z07	CAP,CER 106KX7R1H-CP
MAIN-P.W.Board			C2222	08-32877Z11	CAP,CER 224MX7R1H-CP
MAIN-P.W.Board			C2223	08-37972Z07	CAP,CER 106KX7R1H-CP
MAIN-P.W.Board			C2224	08-32877Z08	CAP,CER 106KX7R1A-CP
MAIN-P.W.Board			C2227	08-37972Z03	CAP,CER 226KX7R1C-CP
MAIN-P.W.Board			C2228	08-32877Z11	CAP,CER 224MX7R1H-CP
MAIN-P.W.Board			C2301	08-32877Z11	CAP,CER 224MX7R1H-CP
MAIN-P.W.Board			C2303	08-32877Z11	CAP,CER 224MX7R1H-CP
MAIN-P.W.Board			C2304	08-32877Z11	CAP,CER 224MX7R1H-CP
MAIN-P.W.Board			C2305	08-32877Z11	CAP,CER 224MX7R1H-CP
MAIN-P.W.Board			C2306	08-32877Z11	CAP,CER 224MX7R1H-CP
MAIN-P.W.Board			C2308	08-32877Z11	CAP,CER 224MX7R1H-CP
MAIN-P.W.Board			C2310	08-32877Z11	CAP,CER 224MX7R1H-CP
MAIN-P.W.Board			C2311	08-32877Z11	CAP,CER 224MX7R1H-CP
MAIN-P.W.Board			C2312	08-32877Z11	CAP,CER 224MX7R1H-CP
MAIN-P.W.Board			C2313	08-32877Z11	CAP,CER 224MX7R1H-CP
MAIN-P.W.Board			C2314	08-32877Z08	CAP,CER 106KX7R1A-CP
MAIN-P.W.Board			C2315	08-32877Z08	CAP,CER 106KX7R1A-CP
MAIN-P.W.Board			C2318	08-32877Z08	CAP,CER 106KX7R1A-CP
MAIN-P.W.Board			C2320	08-32877Z08	CAP,CER 106KX7R1A-CP
MAIN-P.W.Board			C2321	08-32877Z08	CAP,CER 106KX7R1A-CP
MAIN-P.W.Board			C2324	08-32877Z11	CAP,CER 224MX7R1H-CP
MAIN-P.W.Board			C2325	08-32877Z04	CAP,CER106KX7R0JQ2CP
MAIN-P.W.Board			C2327	08-32877Z11	CAP,CER 224MX7R1H-CP
MAIN-P.W.Board			C2328	08-32871Z15	CAP,CER 104KX7R0J-CP
MAIN-P.W.Board			C2329	08-32877Z11	CAP,CER 224MX7R1H-CP
MAIN-P.W.Board			C2330	08-32827Z34	CAP,CER 181JCG1HQ2CP
MAIN-P.W.Board			C2332	08-32877Z11	CAP,CER 224MX7R1H-CP
MAIN-P.W.Board			C2335	08-32877Z11	CAP,CER 224MX7R1H-CP
MAIN-P.W.Board			C2336	08-32877Z11	CAP,CER 224MX7R1H-CP
MAIN-P.W.Board			C2339	08-32877Z11	CAP,CER 224MX7R1H-CP
MAIN-P.W.Board			C2340	08-32877Z11	CAP,CER 224MX7R1H-CP
MAIN-P.W.Board			C2341	08-37526Z27	CAP,CER 101J-CG1H-CP
MAIN-P.W.Board			C2342	08-37802Z06	CAP,CER 103KX7R1A-CP
MAIN-P.W.Board			C2343	08-32861Z02	CAP,CER 106KX7R1C-CP
MAIN-P.W.Board			C2344	08-32877Z08	CAP,CER 106KX7R1A-CP
MAIN-P.W.Board			C2346	08-32877Z08	CAP,CER 106KX7R1A-CP
MAIN-P.W.Board			C2347	08-32877Z08	CAP,CER 106KX7R1A-CP
MAIN-P.W.Board			C2354	08-32877Z08	CAP,CER 106KX7R1A-CP
MAIN-P.W.Board			C2355	08-32877Z08	CAP,CER 106KX7R1A-CP
MAIN-P.W.Board			C2356	08-32877Z04	CAP,CER106KX7R0JQ2CP
MAIN-P.W.Board			C2357	08-32877Z08	CAP,CER 106KX7R1A-CP
MAIN-P.W.Board			C2400	08-38014Z06	CAP,CER 224KX5R1C-CP
MAIN-P.W.Board			C2401	08-32861Z02	CAP,CER 106KX7R1C-CP
MAIN-P.W.Board			C2402	08-32861Z02	CAP,CER 106KX7R1C-CP
MAIN-P.W.Board			C2403	08-32877Z10	CAP,CER 225KX7R1E-CP
MAIN-P.W.Board			C2404	08-32878Z11	CAP,CER 105KX7R1C-CP
MAIN-P.W.Board			C2405	08-32877Z11	CAP,CER 224MX7R1H-CP
MAIN-P.W.Board			C2406	08-32861Z02	CAP,CER 106KX7R1C-CP
MAIN-P.W.Board			C2407	08-32861Z02	CAP,CER 106KX7R1C-CP
MAIN-P.W.Board			C2500	08-32871Z09	CAP,CER103KX7R1HQ2CP
MAIN-P.W.Board			C2503	08-32827Z25	CAP,CER 151JCG1HQ2CP
MAIN-P.W.Board			C2504	08-32877Z11	CAP,CER 224MX7R1H-CP
MAIN-P.W.Board			C2505	08-32871Z07	CAP,CER103KX7R1CQ2CP
MAIN-P.W.Board			C2506	08-32877Z11	CAP,CER 224MX7R1H-CP
MAIN-P.W.Board			C2510	08-32871Z02	CAP,CER152KX7R1HQ2CP
MAIN-P.W.Board			C2520	08-32871Z19	CAP,CER 104KX7R1A-CP
MAIN-P.W.Board			C2522	08-37972Z07	CAP,CER 106KX7R1H-CP
MAIN-P.W.Board			C2530	08-32878Z03	CAP,CER104KX7R1HQ2CP
MAIN-P.W.Board			C2560	08-32871Z09	CAP,CER103KX7R1HQ2CP
MAIN-P.W.Board			C2570	08-32877Z12	CAP,CER 105KX7R1H-CP
MAIN-P.W.Board			C2588	08-32877Z08	CAP,CER 106KX7R1A-CP
MAIN-P.W.Board			C2589	08-32877Z07	CAP,CER 225KX7R1A-CP
MAIN-P.W.Board			C2600	08-32871Z07	CAP,CER103KX7R1CQ2CP
MAIN-P.W.Board			C2601	08-32871Z30	CAP,CER 473KX7R1E-CP
MAIN-P.W.Board			C2602	08-32861Z02	CAP,CER 106KX7R1C-CP
MAIN-P.W.Board			C2603	08-32877Z12	CAP,CER 105KX7R1H-CP
MAIN-P.W.Board			C2604	08-32877Z12	CAP,CER 105KX7R1H-CP
MAIN-P.W.Board			C2605	08-37526Z26	CAP,CER 82RJ-CG1H-CP
MAIN-P.W.Board			C2606	08-37526Z26	CAP,CER 82RJ-CG1H-CP
MAIN-P.W.Board			C2620	08-32871Z28	CAP,CER 223KX7R1E-CP

P.W.Board	MIS	MODEL	Ref.	Parts No.	Parts Name
MAIN-P.W.Board			C2716	08-32871Z20	CAP,CER 224KX7R1A-CP
MAIN-P.W.Board			C2731	08-32827Z33	CAP,CER 102JCG1HQ2CP
MAIN-P.W.Board			C2740	08-32827Z26	CAP,CER 221JCG1HQ2CP
MAIN-P.W.Board			C2741	08-32827Z26	CAP,CER 221JCG1HQ2CP
MAIN-P.W.Board			C2742	08-32827Z26	CAP,CER 221JCG1HQ2CP
MAIN-P.W.Board			C2743	08-32877Z11	CAP,CER 224MX7R1H-CP
MAIN-P.W.Board			C2744	08-32871Z20	CAP,CER 224KX7R1A-CP
MAIN-P.W.Board			C2751	08-32861Z07	CAP,CER 225KX7R1H-CP
MAIN-P.W.Board			C2904	08-32871Z01	CAP,CER102KX7R1HQ2CP
MAIN-P.W.Board			C2905	08-32871Z01	CAP,CER102KX7R1HQ2CP
MAIN-P.W.Board			CB1800	09-06127Z02	WTB,S2B-PH-SM4-TB-E6
MAIN-P.W.Board			CB2700	09-39556Z01	WTB,2515WR-16P-B -T
MAIN-P.W.Board			CB2701	09-38369Z05	WTB,SM12B-PUDK-D -EG
MAIN-P.W.Board			CB2703	09-38369Z01	WTB,SM10B-PUDK-D -EU
MAIN-P.W.Board			CB2704	09-16961Z09	WTB,A1257WV0-10PS-ED
MAIN-P.W.Board			CH2900	09-42335Z01	BTB,DT01-140FS-10-EZ
MAIN-P.W.Board			D1600	48-36691Z01	DIO,1SS301 -CP
MAIN-P.W.Board			D1601	48-36817Z01	DIO,1SS352,H3XGF -CP
MAIN-P.W.Board			D1650	48-37039Z01	DIO,1SS300 -CP
MAIN-P.W.Board			D1651	48-37039Z01	DIO,1SS300 -CP
MAIN-P.W.Board			D1652	48-37039Z01	DIO,1SS300 -CP
MAIN-P.W.Board			D1800	48-37040Z01	DIO,1SS302A -CP
MAIN-P.W.Board			D2300	48-37180Z01	DIO,RR1LAM4STFTR -E1
MAIN-P.W.Board			D2500	48-36817Z01	DIO,1SS352,H3XGF -CP
MAIN-P.W.Board			D2501	48-36691Z01	DIO,1SS301 -CP
MAIN-P.W.Board			D2530	48-36817Z01	DIO,1SS352,H3XGF -CP
MAIN-P.W.Board			D2560	48-36691Z01	DIO,1SS301 -CP
MAIN-P.W.Board			E1000	23-31100Z07	CAP,MAK 101-1A -E6
MAIN-P.W.Board			E1001	23-31100Z10	CAP,MAK 22R-1C -E3
MAIN-P.W.Board			E1600	23S75244Y37	CAP,ELY 101-1V -E6
MAIN-P.W.Board			E1700	23-28540Z22	CAP,MZR 221-1E -E6
MAIN-P.W.Board			E1701	23-28540Z22	CAP,MZR 221-1E -E6
MAIN-P.W.Board			E2300	23S75244Y34	CAP,ELY 22R-1V -E3
MAIN-P.W.Board			E2303	23-31100Z12	CAP,MAK 101-1C -E6
MAIN-P.W.Board			E2304	23S75244Y36	CAP,ELY 47R-1V -E6
MAIN-P.W.Board			E2305	23S75244Y38	CAP,ELY 221-1V -EA
MAIN-P.W.Board			E2306	23-31100Z01	CAP,MAK 22R-0J -E2
MAIN-P.W.Board			E2307	23-31100Z11	CAP,MAK 47R-1C -E6
MAIN-P.W.Board			E2700	23-39892Z01	CAP,CST 192-1E -T
MAIN-P.W.Board			E2701	23-39892Z01	CAP,CST 192-1E -T
MAIN-P.W.Board			IC1000	51-39164Z01	AK7738AVQ -QEA
MAIN-P.W.Board			IC1001	51-40916Z01	NJM8080RB1-TE1 -SE2
MAIN-P.W.Board			IC1400	51-30408Z01	AK4438VN -LE2
MAIN-P.W.Board			IC1401	51-24841Z01	BR24T32F-WGE2 -SE2
MAIN-P.W.Board			IC1450	51-40916Z01	NJM8080RB1-TE1 -SE2
MAIN-P.W.Board			IC1451	51-40916Z01	NJM8080RB1-TE1 -SE2
MAIN-P.W.Board			IC1452	51-40916Z01	NJM8080RB1-TE1 -SE2
MAIN-P.W.Board			IC1700	51-38525Z01	FDA901A-VYT -QEA
MAIN-P.W.Board			IC1701	51T55336Y03	TC7SH04FU,LJ -CP
MAIN-P.W.Board			IC1800	51-29406Z03	SAF7751HV/N207Z -QT
MAIN-P.W.Board			IC1801	51-42538Z01	74LVC2GU04GW-Q100-CP
MAIN-P.W.Board			IC2000	51-29945Z01	SAF3600ELV/1040A-BEA
MAIN-P.W.Board			IC2001	51-38431Z01	W25Q80DVSNAG -ST
MAIN-P.W.Board			IC2001	83-44315Z51	CR6c 21GDA_US_Saturn_IC2001
MAIN-P.W.Board			IC2200	51-36700Z01	RTQ2104BGSP-QA -SE2
MAIN-P.W.Board			IC2220	51-36700Z01	RTQ2104BGSP-QA -SE2
MAIN-P.W.Board			IC2300	51-23593Z02	BD00IC0WEFJ-ME2 -SE2
MAIN-P.W.Board			IC2302	51-23593Z02	BD00IC0WEFJ-ME2 -SE2
MAIN-P.W.Board			IC2303	51-23593Z05	BD00IA5EEFJ-ME2 -SE2
MAIN-P.W.Board			IC2304	51-23593Z02	BD00IC0WEFJ-ME2 -SE2
MAIN-P.W.Board			IC2305	51-19576Z01	TPD1052F-TE85L -CP
MAIN-P.W.Board			IC2307	51-38519Z01	NJM1431AU-T-TE1 -NE2
MAIN-P.W.Board			IC2309	51-37801Z01	NJM11100F1-TE2 -CP
MAIN-P.W.Board			IC2310	51-23593Z02	BD00IC0WEFJ-ME2 -SE2
MAIN-P.W.Board			IC2400	51-43030Z01	NJW4191R-A-TE2 -SE2
MAIN-P.W.Board			IC2501	51-02032Z02	TC7SET02FU,LJ -CP
MAIN-P.W.Board			IC2510	51-40529Z25	S-19100N36H-M5T2U-CP
MAIN-P.W.Board			IC2580	51-40916Z01	NJM8080RB1-TE1 -SE2
MAIN-P.W.Board			IC2701	51T25183Y04	TC7SET08FU,LJ -CP
MAIN-P.W.Board			IC2703	51T15194Y03	74VHCT08AFT-EL -SE2
MAIN-P.W.Board			IC2704	51T25183Y04	TC7SET08FU,LJ -CP
MAIN-P.W.Board			L1000	24-39836Z04	FBI,BLM15AG102SZ1-CP
MAIN-P.W.Board			L1001	24-39836Z04	FBI,BLM15AG102SZ1-CP
MAIN-P.W.Board			L1003	24-39836Z03	FBI,BLM15AG601SZ1-CP
MAIN-P.W.Board			L1700	24-39171Z01	IND,VAMV08089A10RME9
MAIN-P.W.Board			L1701	24-39171Z01	IND,VAMV08089A10RME9
MAIN-P.W.Board			L1702	24-39171Z01	IND,VAMV08089A10RME9
MAIN-P.W.Board			L1703	24-39171Z01	IND,VAMV08089A10RME9

P.W.Board	MIS	MODEL	Ref.	Parts No.	Parts Name
MAIN-P.W.Board			L1800	24-40401Z01	FBI,BLM15HD601SZ1-CP
MAIN-P.W.Board			L1801	24-40401Z01	FBI,BLM15HD601SZ1-CP
MAIN-P.W.Board			L1802	24-40401Z01	FBI,BLM15HD601SZ1-CP
MAIN-P.W.Board			L1803	24-38363Z10	IND,LQH32NH 47RJ -CP
MAIN-P.W.Board			L1804	24-38363Z10	IND,LQH32NH 47RJ -CP
MAIN-P.W.Board			L1805	24-40401Z01	FBI,BLM15HD601SZ1-CP
MAIN-P.W.Board			L1807	24-40401Z01	FBI,BLM15HD601SZ1-CP
MAIN-P.W.Board			L1808	24-32593Z05	IND,LQW18AN R22J -CP
MAIN-P.W.Board			L1809	24-38482Z13	IND,AWCS231715R82JCP
MAIN-P.W.Board			L1810	24-32593Z03	IND,LQW18AN R27J -CP
MAIN-P.W.Board			L1811	24-38482Z16	IND,AWCS2317153R3JCP
MAIN-P.W.Board			L1812	24-32593Z23	IND,LQW18AN R082J-CP
MAIN-P.W.Board			L1813	24-32593Z25	IND,LQW18AN R15J -CP
MAIN-P.W.Board			L1814	24-40402Z02	FBI,BLM18PG181SZ1-CP
MAIN-P.W.Board			L1815	24-40402Z02	FBI,BLM18PG181SZ1-CP
MAIN-P.W.Board			L1816	24-32593Z23	IND,LQW18AN R082J-CP
MAIN-P.W.Board			L2002	24-40402Z05	FBI,BLM18KG221SZ1-CP
MAIN-P.W.Board			L2004	24-40402Z02	FBI,BLM18PG181SZ1-CP
MAIN-P.W.Board			L2005	24-40402Z01	FBI,BLM18PG121SZ1-CP
MAIN-P.W.Board			L2200	24-40402Z05	FBI,BLM18KG221SZ1-CP
MAIN-P.W.Board			L2201	24-31657Z02	IND,FSD0420D 2R2ME2
MAIN-P.W.Board			L2220	24-40402Z11	FBI,BLM18KG700TZ1-CP
MAIN-P.W.Board			L2221	24-31657Z02	IND,FSD0420D 2R2ME2
MAIN-P.W.Board			L2401	24-38469Z04	IND,AWVS606045102ME6
MAIN-P.W.Board			L2402	24-38469Z04	IND,AWVS606045102ME6
MAIN-P.W.Board			L2705	24-39836Z13	FBI,BLM15BD102SZ1-CP
MAIN-P.W.Board			LD2300	48-43424Z01	LED,RED SML-010LT-CP
MAIN-P.W.Board			PS2700	48-16589Z03	POLY,SW SMDC150F -E2
MAIN-P.W.Board			Q1600	48-37067Z01	TR,RN2102MFV -CP
MAIN-P.W.Board			Q1601	48-37066Z07	TR,RN1103MFV -CP
MAIN-P.W.Board			Q1602	48-37066Z03	TR,RN1107MFV -CP
MAIN-P.W.Board			Q1603	48-37066Z03	TR,RN1107MFV -CP
MAIN-P.W.Board			Q1604	48-37066Z07	TR,RN1103MFV -CP
MAIN-P.W.Board			Q1605	48-28871Z02	TR,RN4982-TE85L -CP
MAIN-P.W.Board			Q1650	48-38744Z01	TR,HN1C03FU-B -CP
MAIN-P.W.Board			Q1651	48-38744Z01	TR,HN1C03FU-B -CP
MAIN-P.W.Board			Q1652	48-38744Z01	TR,HN1C03FU-B -CP
MAIN-P.W.Board			Q1700	48-37066Z06	TR,RN1116MFV -CP
MAIN-P.W.Board			Q2300	48-28871Z01	TR,RN4983-TE85L -CP
MAIN-P.W.Board			Q2301	48-37066Z07	TR,RN1103MFV -CP
MAIN-P.W.Board			Q2302	48-37059Z01	TR,2SC4116-GR -CP
MAIN-P.W.Board			Q2303	48T65384Y03	TR,2SA1312-BL-85L-CP
MAIN-P.W.Board			Q2304	48-37066Z07	TR,RN1103MFV -CP
MAIN-P.W.Board			Q2305	48-20064Z01	TR,2SC3076-Y-16L -E5
MAIN-P.W.Board			Q2501	48-37066Z01	TR,RN1102MFV -CP
MAIN-P.W.Board			Q2502	48-37057Z01	TR,2SA1586-GR -CP
MAIN-P.W.Board			Q2510	48-28871Z01	TR,RN4983-TE85L -CP
MAIN-P.W.Board			Q2520	48-37066Z02	TR,RN1105MFV -CP
MAIN-P.W.Board			Q2530	48-28871Z01	TR,RN4983-TE85L -CP
MAIN-P.W.Board			Q2560	48-37057Z01	TR,2SA1586-GR -CP
MAIN-P.W.Board			Q2570	48-37066Z07	TR,RN1103MFV -CP
MAIN-P.W.Board			Q2620	48-28871Z01	TR,RN4983-TE85L -CP
MAIN-P.W.Board			R1000	06S15615Y25	RES,RK 101J 1/16 -CP
MAIN-P.W.Board			R1002	06S15615Y37	RES,RK 331J 1/16 -CP
MAIN-P.W.Board			R1003	06S15615Y25	RES,RK 101J 1/16 -CP
MAIN-P.W.Board			R1004	06S15615Y35	RES,RK 271J 1/16 -CP
MAIN-P.W.Board			R1005	06S65415Y41	RES,RK 223F 1/16 -CP
MAIN-P.W.Board			R1006	06S65415Y41	RES,RK 223F 1/16 -CP
MAIN-P.W.Board			R1007	06S15615Y29	RES,RK 151J 1/16 -CP
MAIN-P.W.Board			R1008	06S65415Y43	RES,RK 333F 1/16 -CP
MAIN-P.W.Board			R1009	06S15615Y23	RES,RK 82RJ 1/16 -CP
MAIN-P.W.Board			R1011	06S65415Y43	RES,RK 333F 1/16 -CP
MAIN-P.W.Board			R1013	06S15615Y25	RES,RK 101J 1/16 -CP
MAIN-P.W.Board			R1014	06S15615Y29	RES,RK 151J 1/16 -CP
MAIN-P.W.Board			R1015	06S15615Y29	RES,RK 151J 1/16 -CP
MAIN-P.W.Board			R1016	06S15615Y31	RES,RK 181J 1/16 -CP
MAIN-P.W.Board			R1018	06S15615Y29	RES,RK 151J 1/16 -CP
MAIN-P.W.Board			R1022	06S15615Y25	RES,RK 101J 1/16 -CP
MAIN-P.W.Board			R1023	06S15615Y57	RES,RK 222J 1/16 -CP
MAIN-P.W.Board			R1026	06S15615Y23	RES,RK 82RJ 1/16 -CP
MAIN-P.W.Board			R1027	06S65415Y33	RES,RK 472F 1/16 -CP
MAIN-P.W.Board			R1034	06-38194Z10	RES,RK 333F 1/4 -CP
MAIN-P.W.Board			R1035	06S65415Y34	RES,RK 562F 1/16 -CP
MAIN-P.W.Board			R1036	06S65415Y34	RES,RK 562F 1/16 -CP
MAIN-P.W.Board			R1037	06S65415Y34	RES,RK 562F 1/16 -CP
MAIN-P.W.Board			R1038	06S65415Y34	RES,RK 562F 1/16 -CP
MAIN-P.W.Board			R1039	06-38194Z10	RES,RK 333F 1/4 -CP
MAIN-P.W.Board			R1040	06-38194Z10	RES,RK 333F 1/4 -CP

P.W.Board	MIS	MODEL	Ref.	Parts No.	Parts Name
MAIN-P.W.Board			R1041	06-38194Z10	RES,RK 333F 1/4 -CP
MAIN-P.W.Board			R1045	06S15615Y35	RES,RK 271J 1/16 -CP
MAIN-P.W.Board			R1047	06S15615Y25	RES,RK 101J 1/16 -CP
MAIN-P.W.Board			R1400	06S15615Y73	RES,RK 103J 1/16 -CP
MAIN-P.W.Board			R1401	06S15615Y73	RES,RK 103J 1/16 -CP
MAIN-P.W.Board			R1402	06S15615Y73	RES,RK 103J 1/16 -CP
MAIN-P.W.Board			R1404	06S15615Y73	RES,RK 103J 1/16 -CP
MAIN-P.W.Board			R1408	06S15615Y57	RES,RK 222J 1/16 -CP
MAIN-P.W.Board			R1409	06S15615Y57	RES,RK 222J 1/16 -CP
MAIN-P.W.Board			R1450	06-25919Z07	RES,RK 243F 1/16 -CP
MAIN-P.W.Board			R1451	06S65415Y66	RES,RK 622F 1/16 -CP
MAIN-P.W.Board			R1452	06S65415Y49	RES,RK 104F 1/16 -CP
MAIN-P.W.Board			R1453	06-25919Z07	RES,RK 243F 1/16 -CP
MAIN-P.W.Board			R1454	06S65415Y66	RES,RK 622F 1/16 -CP
MAIN-P.W.Board			R1455	06S65415Y49	RES,RK 104F 1/16 -CP
MAIN-P.W.Board			R1456	06S65415Y46	RES,RK 563F 1/16 -CP
MAIN-P.W.Board			R1457	06-25919Z02	RES,RK 912F 1/16 -CP
MAIN-P.W.Board			R1458	06S15616Y34	RES,RK 125J 1/16 -CP
MAIN-P.W.Board			R1459	06S65415Y92	RES,RK 132F 1/16 -CP
MAIN-P.W.Board			R1460	06S65415Y41	RES,RK 223F 1/16 -CP
MAIN-P.W.Board			R1461	06S65415Y33	RES,RK 472F 1/16 -CP
MAIN-P.W.Board			R1462	06S65415Y46	RES,RK 563F 1/16 -CP
MAIN-P.W.Board			R1463	06S15616Y34	RES,RK 125J 1/16 -CP
MAIN-P.W.Board			R1464	06-25919Z02	RES,RK 912F 1/16 -CP
MAIN-P.W.Board			R1465	06S65415Y46	RES,RK 563F 1/16 -CP
MAIN-P.W.Board			R1466	06S65415Y92	RES,RK 132F 1/16 -CP
MAIN-P.W.Board			R1467	06S65415Y41	RES,RK 223F 1/16 -CP
MAIN-P.W.Board			R1468	06S65415Y33	RES,RK 472F 1/16 -CP
MAIN-P.W.Board			R1469	06S65415Y46	RES,RK 563F 1/16 -CP
MAIN-P.W.Board			R1470	06S65415Y46	RES,RK 563F 1/16 -CP
MAIN-P.W.Board			R1471	06-25919Z02	RES,RK 912F 1/16 -CP
MAIN-P.W.Board			R1472	06S15616Y34	RES,RK 125J 1/16 -CP
MAIN-P.W.Board			R1473	06S65415Y92	RES,RK 132F 1/16 -CP
MAIN-P.W.Board			R1474	06S65415Y41	RES,RK 223F 1/16 -CP
MAIN-P.W.Board			R1475	06S65415Y33	RES,RK 472F 1/16 -CP
MAIN-P.W.Board			R1476	06S65415Y46	RES,RK 563F 1/16 -CP
MAIN-P.W.Board			R1477	06S15616Y34	RES,RK 125J 1/16 -CP
MAIN-P.W.Board			R1478	06-25919Z02	RES,RK 912F 1/16 -CP
MAIN-P.W.Board			R1479	06S65415Y46	RES,RK 563F 1/16 -CP
MAIN-P.W.Board			R1480	06S65415Y92	RES,RK 132F 1/16 -CP
MAIN-P.W.Board			R1481	06S65415Y41	RES,RK 223F 1/16 -CP
MAIN-P.W.Board			R1482	06S65415Y33	RES,RK 472F 1/16 -CP
MAIN-P.W.Board			R1483	06S65415Y46	RES,RK 563F 1/16 -CP
MAIN-P.W.Board			R1600	06S15615Y37	RES,RK 331J 1/16 -CP
MAIN-P.W.Board			R1601	06S15615Y73	RES,RK 103J 1/16 -CP
MAIN-P.W.Board			R1603	06S65415Y87	RES,RK 431F 1/16 -CP
MAIN-P.W.Board			R1604	06S15615Y81	RES,RK 223J 1/16 -CP
MAIN-P.W.Board			R1605	06S15615Y79	RES,RK 183J 1/16 -CP
MAIN-P.W.Board			R1608	06S15616Y23	RES,RK JUMPER1/16-CP
MAIN-P.W.Board			R1650	06-38173Z51	RES,RK 121J 1/4 -CP
MAIN-P.W.Board			R1651	06-38173Z49	RES,RK 101J 1/4 -CP
MAIN-P.W.Board			R1652	06-38173Z51	RES,RK 121J 1/4 -CP
MAIN-P.W.Board			R1653	06-38173Z49	RES,RK 101J 1/4 -CP
MAIN-P.W.Board			R1654	06S65415Y45	RES,RK 473F 1/16 -CP
MAIN-P.W.Board			R1655	06S65415Y45	RES,RK 473F 1/16 -CP
MAIN-P.W.Board			R1656	06S45674W69	RES,RK 332J 1/10 -CP
MAIN-P.W.Board			R1657	06S45674W69	RES,RK 332J 1/10 -CP
MAIN-P.W.Board			R1658	06-38173Z51	RES,RK 121J 1/4 -CP
MAIN-P.W.Board			R1659	06-38173Z49	RES,RK 101J 1/4 -CP
MAIN-P.W.Board			R1660	06-38173Z51	RES,RK 121J 1/4 -CP
MAIN-P.W.Board			R1661	06-38173Z49	RES,RK 101J 1/4 -CP
MAIN-P.W.Board			R1662	06S65415Y45	RES,RK 473F 1/16 -CP
MAIN-P.W.Board			R1663	06S65415Y45	RES,RK 473F 1/16 -CP
MAIN-P.W.Board			R1664	06-38173Z51	RES,RK 121J 1/4 -CP
MAIN-P.W.Board			R1665	06-38173Z49	RES,RK 101J 1/4 -CP
MAIN-P.W.Board			R1666	06-38173Z51	RES,RK 121J 1/4 -CP
MAIN-P.W.Board			R1667	06-38173Z49	RES,RK 101J 1/4 -CP
MAIN-P.W.Board			R1668	06S65415Y45	RES,RK 473F 1/16 -CP
MAIN-P.W.Board			R1669	06S65415Y45	RES,RK 473F 1/16 -CP
MAIN-P.W.Board			R1670	06S45674W69	RES,RK 332J 1/10 -CP
MAIN-P.W.Board			R1671	06S45674W69	RES,RK 332J 1/10 -CP
MAIN-P.W.Board			R1672	06S45674W69	RES,RK 332J 1/10 -CP
MAIN-P.W.Board			R1673	06S45674W69	RES,RK 332J 1/10 -CP
MAIN-P.W.Board			R1700	06S15615Y73	RES,RK 103J 1/16 -CP
MAIN-P.W.Board			R1702	06S15615Y73	RES,RK 103J 1/16 -CP
MAIN-P.W.Board			R1703	06S45674W09	RES,RK 10RJ 1/10 -CP
MAIN-P.W.Board			R1704	06S45674W09	RES,RK 10RJ 1/10 -CP
MAIN-P.W.Board			R1705	06S45674W09	RES,RK 10RJ 1/10 -CP

P.W.Board	MIS	MODEL	Ref.	Parts No.	Parts Name
MAIN-P.W.Board			R1706	06S45674W09	RES,RK 10RJ 1/10 -CP
MAIN-P.W.Board			R1707	06-38173Z25	RES,RK 10RJ 1/4 -CP
MAIN-P.W.Board			R1708	06-38173Z25	RES,RK 10RJ 1/4 -CP
MAIN-P.W.Board			R1709	06-38173Z25	RES,RK 10RJ 1/4 -CP
MAIN-P.W.Board			R1710	06-38173Z25	RES,RK 10RJ 1/4 -CP
MAIN-P.W.Board			R1711	06S45674W09	RES,RK 10RJ 1/10 -CP
MAIN-P.W.Board			R1712	06S45674W09	RES,RK 10RJ 1/10 -CP
MAIN-P.W.Board			R1713	06S45674W09	RES,RK 10RJ 1/10 -CP
MAIN-P.W.Board			R1714	06S45674W09	RES,RK 10RJ 1/10 -CP
MAIN-P.W.Board			R1715	06-38173Z25	RES,RK 10RJ 1/4 -CP
MAIN-P.W.Board			R1716	06-38173Z25	RES,RK 10RJ 1/4 -CP
MAIN-P.W.Board			R1717	06-38173Z25	RES,RK 10RJ 1/4 -CP
MAIN-P.W.Board			R1718	06-38173Z25	RES,RK 10RJ 1/4 -CP
MAIN-P.W.Board			R1719	06S15615Y73	RES,RK 103J 1/16 -CP
MAIN-P.W.Board			R1720	06S65415Y61	RES,RK 105F 1/16 -CP
MAIN-P.W.Board			R1721	06S65415Y61	RES,RK 105F 1/16 -CP
MAIN-P.W.Board			R1722	06S65415Y61	RES,RK 105F 1/16 -CP
MAIN-P.W.Board			R1723	06S65415Y61	RES,RK 105F 1/16 -CP
MAIN-P.W.Board			R1724	06S65415Y61	RES,RK 105F 1/16 -CP
MAIN-P.W.Board			R1725	06S65415Y61	RES,RK 105F 1/16 -CP
MAIN-P.W.Board			R1726	06S65415Y61	RES,RK 105F 1/16 -CP
MAIN-P.W.Board			R1727	06S65415Y61	RES,RK 105F 1/16 -CP
MAIN-P.W.Board			R1728	06S65415Y60	RES,RK 824F 1/16 -CP
MAIN-P.W.Board			R1729	06S65415Y60	RES,RK 824F 1/16 -CP
MAIN-P.W.Board			R1730	06S65415Y60	RES,RK 824F 1/16 -CP
MAIN-P.W.Board			R1731	06S65415Y60	RES,RK 824F 1/16 -CP
MAIN-P.W.Board			R1732	06S65415Y60	RES,RK 824F 1/16 -CP
MAIN-P.W.Board			R1733	06S65415Y60	RES,RK 824F 1/16 -CP
MAIN-P.W.Board			R1734	06S65415Y60	RES,RK 824F 1/16 -CP
MAIN-P.W.Board			R1735	06S65415Y60	RES,RK 824F 1/16 -CP
MAIN-P.W.Board			R1806	06S15615Y73	RES,RK 103J 1/16 -CP
MAIN-P.W.Board			R1807	06S15615Y73	RES,RK 103J 1/16 -CP
MAIN-P.W.Board			R1811	06S15616Y23	RES,RK JUMPER1/16-CP
MAIN-P.W.Board			R1812	06S15616Y23	RES,RK JUMPER1/16-CP
MAIN-P.W.Board			R1813	06S15616Y23	RES,RK JUMPER1/16-CP
MAIN-P.W.Board			R1814	06S15616Y23	RES,RK JUMPER1/16-CP
MAIN-P.W.Board			R1821	06S15615Y25	RES,RK 101J 1/16 -CP
MAIN-P.W.Board			R1822	06S15615Y25	RES,RK 101J 1/16 -CP
MAIN-P.W.Board			R1823	06S45675W43	RES,RK JUMPER1/10-CP
MAIN-P.W.Board			R1829	06S15616Y23	RES,RK JUMPER1/16-CP
MAIN-P.W.Board			R1835	06S15615Y09	RES,RK 22RJ 1/16 -CP
MAIN-P.W.Board			R1836	06S15615Y09	RES,RK 22RJ 1/16 -CP
MAIN-P.W.Board			R1838	06S15615Y09	RES,RK 22RJ 1/16 -CP
MAIN-P.W.Board			R1846	06S15615Y57	RES,RK 222J 1/16 -CP
MAIN-P.W.Board			R1847	06S15615Y57	RES,RK 222J 1/16 -CP
MAIN-P.W.Board			R1851	06S15594Y14	RES,RK 474F 1/10 -CP
MAIN-P.W.Board			R1852	06S15594Y14	RES,RK 474F 1/10 -CP
MAIN-P.W.Board			R1853	06S65415Y12	RES,RK 82RF 1/16 -CP
MAIN-P.W.Board			R1854	06S45675W43	RES,RK JUMPER1/10-CP
MAIN-P.W.Board			R1855	06S15615Y57	RES,RK 222J 1/16 -CP
MAIN-P.W.Board			R1858	06S15615Y25	RES,RK 101J 1/16 -CP
MAIN-P.W.Board			R2007	06S15615Y73	RES,RK 103J 1/16 -CP
MAIN-P.W.Board			R2008	06S15615Y73	RES,RK 103J 1/16 -CP
MAIN-P.W.Board			R2009	06S15615Y73	RES,RK 103J 1/16 -CP
MAIN-P.W.Board			R2014	06S15615Y23	RES,RK 82RJ 1/16 -CP
MAIN-P.W.Board			R2016	06S15615Y25	RES,RK 101J 1/16 -CP
MAIN-P.W.Board			R2023	06S15615Y57	RES,RK 222J 1/16 -CP
MAIN-P.W.Board			R2024	06S15616Y23	RES,RK JUMPER1/16-CP
MAIN-P.W.Board			R2033	06S15615Y57	RES,RK 222J 1/16 -CP
MAIN-P.W.Board			R2200	06S65415Y27	RES,RK 152F 1/16 -CP
MAIN-P.W.Board			R2201	06S65415Y31	RES,RK 332F 1/16 -CP
MAIN-P.W.Board			R2204	06S15615Y05	RES,RK 15RJ 1/16 -CP
MAIN-P.W.Board			R2207	06S65415Y50	RES,RK 124F 1/16 -CP
MAIN-P.W.Board			R2208	06S65415Y99	RES,RK 512F 1/16 -CP
MAIN-P.W.Board			R2209	06S65415Y38	RES,RK 123F 1/16 -CP
MAIN-P.W.Board			R2220	06S65415Y41	RES,RK 223F 1/16 -CP
MAIN-P.W.Board			R2221	06S65415Y30	RES,RK 272F 1/16 -CP
MAIN-P.W.Board			R2224	06S15615Y05	RES,RK 15RJ 1/16 -CP
MAIN-P.W.Board			R2225	06S65415Y50	RES,RK 124F 1/16 -CP
MAIN-P.W.Board			R2226	06S65415Y66	RES,RK 622F 1/16 -CP
MAIN-P.W.Board			R2231	06S65415Y22	RES,RK 561F 1/16 -CP
MAIN-P.W.Board			R2300	06S65415Y21	RES,RK 471F 1/16 -CP
MAIN-P.W.Board			R2301	06S65415Y36	RES,RK 822F 1/16 -CP
MAIN-P.W.Board			R2304	06S65415Y68	RES,RK 911F 1/16 -CP
MAIN-P.W.Board			R2305	06S65415Y52	RES,RK 184F 1/16 -CP
MAIN-P.W.Board			R2306	06S65415Y34	RES,RK 562F 1/16 -CP
MAIN-P.W.Board			R2307	06-25919Z15	RES,RK 114F 1/16 -CP
MAIN-P.W.Board			R2312	06S65415Y33	RES,RK 472F 1/16 -CP

P.W.Board	MIS	MODEL	Ref.	Parts No.	Parts Name
MAIN-P.W.Board			R2313	06S65415Y18	RES,RK 271F 1/16 -CP
MAIN-P.W.Board			R2316	06S65415Y38	RES,RK 123F 1/16 -CP
MAIN-P.W.Board			R2317	06S65415Y30	RES,RK 272F 1/16 -CP
MAIN-P.W.Board			R2318	06S65415Y33	RES,RK 472F 1/16 -CP
MAIN-P.W.Board			R2328	06S65415Y38	RES,RK 123F 1/16 -CP
MAIN-P.W.Board			R2329	06S65415Y30	RES,RK 272F 1/16 -CP
MAIN-P.W.Board			R2330	06S65415Y33	RES,RK 472F 1/16 -CP
MAIN-P.W.Board			R2333	06S65415Y29	RES,RK 222F 1/16 -CP
MAIN-P.W.Board			R2334	06S65415Y18	RES,RK 271F 1/16 -CP
MAIN-P.W.Board			R2335	06S65415Y33	RES,RK 472F 1/16 -CP
MAIN-P.W.Board			R2338	06-25919Z03	RES,RK 113F 1/16 -CP
MAIN-P.W.Board			R2340	06S65415Y38	RES,RK 123F 1/16 -CP
MAIN-P.W.Board			R2341	06S65415Y30	RES,RK 272F 1/16 -CP
MAIN-P.W.Board			R2342	06S65415Y33	RES,RK 472F 1/16 -CP
MAIN-P.W.Board			R2343	06S65415Y25	RES,RK 102F 1/16 -CP
MAIN-P.W.Board			R2349	06S65415Y29	RES,RK 222F 1/16 -CP
MAIN-P.W.Board			R2352	06S65415Y43	RES,RK 333F 1/16 -CP
MAIN-P.W.Board			R2353	06S65415Y26	RES,RK 122F 1/16 -CP
MAIN-P.W.Board			R2355	06-38173Z97	RES,RK 103J 1/4 -CP
MAIN-P.W.Board			R2357	06S65415Y61	RES,RK 105F 1/16 -CP
MAIN-P.W.Board			R2358	06-38174Z22	RES,RK 104J 1/4 -CP
MAIN-P.W.Board			R2359	06S65415Y30	RES,RK 272F 1/16 -CP
MAIN-P.W.Board			R2360	06S65415Y30	RES,RK 272F 1/16 -CP
MAIN-P.W.Board			R2362	06S15593Y69	RES,RK 682F 1/10 -CP
MAIN-P.W.Board			R2363	06-38173Z73	RES,RK 102J 1/4 -CP
MAIN-P.W.Board			R2364	06-38193Z61	RES,RK 331F 1/4 -CP
MAIN-P.W.Board			R2365	06-38193Z67	RES,RK 561F 1/4 -CP
MAIN-P.W.Board			R2366	06-25919Z07	RES,RK 243F 1/16 -CP
MAIN-P.W.Board			R2367	06S45674W07	RES,RK 6R8J 1/10 -CP
MAIN-P.W.Board			R2368	06S65415Y34	RES,RK 562F 1/16 -CP
MAIN-P.W.Board			R2369	06S65415Y48	RES,RK 823F 1/16 -CP
MAIN-P.W.Board			R2377	06S65415Y29	RES,RK 222F 1/16 -CP
MAIN-P.W.Board			R2378	06S65415Y35	RES,RK 682F 1/16 -CP
MAIN-P.W.Board			R2379	06S65415Y99	RES,RK 512F 1/16 -CP
MAIN-P.W.Board			R2380	06S65415Y49	RES,RK 104F 1/16 -CP
MAIN-P.W.Board			R2382	06-38193Z50	RES,RK 111F 1/4 -CP
MAIN-P.W.Board			R2383	06-38193Z50	RES,RK 111F 1/4 -CP
MAIN-P.W.Board			R2384	06-38193Z50	RES,RK 111F 1/4 -CP
MAIN-P.W.Board			R2385	06-38193Z50	RES,RK 111F 1/4 -CP
MAIN-P.W.Board			R2386	06-38193Z50	RES,RK 111F 1/4 -CP
MAIN-P.W.Board			R2387	06-38193Z50	RES,RK 111F 1/4 -CP
MAIN-P.W.Board			R2388	06S65415Y25	RES,RK 102F 1/16 -CP
MAIN-P.W.Board			R2389	06-25919Z05	RES,RK 163F 1/16 -CP
MAIN-P.W.Board			R2390	06S65415Y45	RES,RK 473F 1/16 -CP
MAIN-P.W.Board			R2393	06S65415Y24	RES,RK 821F 1/16 -CP
MAIN-P.W.Board			R2416	06S65415Y47	RES,RK 683F 1/16 -CP
MAIN-P.W.Board			R2417	06S65415Y57	RES,RK 474F 1/16 -CP
MAIN-P.W.Board			R2421	06S45675W43	RES,RK JUMPER1/10-CP
MAIN-P.W.Board			R2500	06-38194Z06	RES,RK 223F 1/4 -CP
MAIN-P.W.Board			R2501	06S65415Y45	RES,RK 473F 1/16 -CP
MAIN-P.W.Board			R2503	06S15615Y61	RES,RK 332J 1/16 -CP
MAIN-P.W.Board			R2504	06S15615Y57	RES,RK 222J 1/16 -CP
MAIN-P.W.Board			R2506	06-25919Z05	RES,RK 163F 1/16 -CP
MAIN-P.W.Board			R2508	06-25919Z07	RES,RK 243F 1/16 -CP
MAIN-P.W.Board			R2509	06S15615Y81	RES,RK 223J 1/16 -CP
MAIN-P.W.Board			R2510	06S15615Y73	RES,RK 103J 1/16 -CP
MAIN-P.W.Board			R2514	06S15593Y61	RES,RK 332F 1/10 -CP
MAIN-P.W.Board			R2515	06S45674W65	RES,RK 222J 1/10 -CP
MAIN-P.W.Board			R2516	06S15593Y81	RES,RK 223F 1/10 -CP
MAIN-P.W.Board			R2518	06S15615Y33	RES,RK 221J 1/16 -CP
MAIN-P.W.Board			R2519	06S15616Y06	RES,RK 224J 1/16 -CP
MAIN-P.W.Board			R2520	06S15615Y65	RES,RK 472J 1/16 -CP
MAIN-P.W.Board			R2521	06S15615Y49	RES,RK 102J 1/16 -CP
MAIN-P.W.Board			R2522	06-38194Z16	RES,RK 563F 1/4 -CP
MAIN-P.W.Board			R2530	06S15615Y81	RES,RK 223J 1/16 -CP
MAIN-P.W.Board			R2531	06-38193Z89	RES,RK 472F 1/4 -CP
MAIN-P.W.Board			R2532	06-38193Z89	RES,RK 472F 1/4 -CP
MAIN-P.W.Board			R2560	06-38173Z73	RES,RK 102J 1/4 -CP
MAIN-P.W.Board			R2561	06S15615Y81	RES,RK 223J 1/16 -CP
MAIN-P.W.Board			R2570	06-38173Z97	RES,RK 103J 1/4 -CP
MAIN-P.W.Board			R2593	06S65415Y33	RES,RK 472F 1/16 -CP
MAIN-P.W.Board			R2594	06S65415Y33	RES,RK 472F 1/16 -CP
MAIN-P.W.Board			R2600	06-38173Z73	RES,RK 102J 1/4 -CP
MAIN-P.W.Board			R2601	06-38173Z73	RES,RK 102J 1/4 -CP
MAIN-P.W.Board			R2602	06S65415Y32	RES,RK 392F 1/16 -CP
MAIN-P.W.Board			R2603	06S65415Y32	RES,RK 392F 1/16 -CP
MAIN-P.W.Board			R2604	06S65415Y51	RES,RK 154F 1/16 -CP
MAIN-P.W.Board			R2605	06S65415Y51	RES,RK 154F 1/16 -CP

P.W.Board	MIS	MODEL	Ref.	Parts No.	Parts Name
MAIN-P.W.Board			R2620	06-38193Z97	RES,RK 103F 1/4 -CP
MAIN-P.W.Board			R2621	06S15593Y91	RES,RK 563F 1/10 -CP
MAIN-P.W.Board			R2622	06S15593Y67	RES,RK 562F 1/10 -CP
MAIN-P.W.Board			R2700	06S15616Y23	RES,RK JUMPER1/16-CP
MAIN-P.W.Board			R2702	06-38194Z19	RES,RK 753F 1/4 -CP
MAIN-P.W.Board			R2703	06-38194Z43	RES,RK 754F 1/4 -CP
MAIN-P.W.Board			R2707	06-38173Z73	RES,RK 102J 1/4 -CP
MAIN-P.W.Board			R2712	06S15616Y23	RES,RK JUMPER1/16-CP
MAIN-P.W.Board			R2713	06S15616Y23	RES,RK JUMPER1/16-CP
MAIN-P.W.Board			R2715	06S45675W43	RES,RK JUMPER1/10-CP
MAIN-P.W.Board			R2716	06S45675W43	RES,RK JUMPER1/10-CP
MAIN-P.W.Board			R2717	06S45675W43	RES,RK JUMPER1/10-CP
MAIN-P.W.Board			R2718	06-38173Z73	RES,RK 102J 1/4 -CP
MAIN-P.W.Board			R2719	06-38173Z73	RES,RK 102J 1/4 -CP
MAIN-P.W.Board			R2720	06-38173Z73	RES,RK 102J 1/4 -CP
MAIN-P.W.Board			R2721	06-38174Z10	RES,RK 333J 1/4 -CP
MAIN-P.W.Board			R2722	06S65415Y41	RES,RK 223F 1/16 -CP
MAIN-P.W.Board			R2723	06S15615Y41	RES,RK 471J 1/16 -CP
MAIN-P.W.Board			R2725	06S15616Y23	RES,RK JUMPER1/16-CP
MAIN-P.W.Board			R2726	06S15616Y23	RES,RK JUMPER1/16-CP
MAIN-P.W.Board			R2727	06-38173Z73	RES,RK 102J 1/4 -CP
MAIN-P.W.Board			R2728	06-38173Z73	RES,RK 102J 1/4 -CP
MAIN-P.W.Board			R2731	06S15616Y23	RES,RK JUMPER1/16-CP
MAIN-P.W.Board			R2904	06S45674W33	RES,RK 101J 1/10 -CP
MAIN-P.W.Board			R2905	06S15615Y73	RES,RK 103J 1/16 -CP
MAIN-P.W.Board			R2906	06S15615Y73	RES,RK 103J 1/16 -CP
MAIN-P.W.Board			R2907	06S15615Y73	RES,RK 103J 1/16 -CP
MAIN-P.W.Board			R2908	06S15615Y73	RES,RK 103J 1/16 -CP
MAIN-P.W.Board			SA1800	48-39964Z01	VST,EZAEG2N50AX -CP
MAIN-P.W.Board			SD2300	48-32691Z03	DIO,SHT RBR3MM60A-CP
MAIN-P.W.Board			SD2400	48-16033Z06	DIOSHT PMEG6010CEJCP
MAIN-P.W.Board			T2700	25-38511Z01	CHOKE,DN-AP3539-9 -T
MAIN-P.W.Board			TML2901	29-25576Z01	IPS-16105T-01Y900-E5
MAIN-P.W.Board			TML2902	29-25576Z01	IPS-16105T-01Y900-E5
MAIN-P.W.Board			TML2904	29-25576Z01	IPS-16105T-01Y900-E5
MAIN-P.W.Board			TML2905	29-25576Z01	IPS-16105T-01Y900-E5
MAIN-P.W.Board			TML2906	29-25576Z01	IPS-16105T-01Y900-E5
MAIN-P.W.Board			VT1800	24-29820Z01	COIL,RF FM M5-N/R-E5
MAIN-P.W.Board			XL1000	91-26661Z02	XTL,NX3225SAAG12.2CP
MAIN-P.W.Board			XL1800	91-26661Z31	XTL,NX3225SAAG55.4CP
MAIN-P.W.Board			ZD2300	48-29509Z14	DIO,ZEN UDZVFH9.1BCP
MAIN-P.W.Board			ZD2500	48-29509Z14	DIO,ZEN UDZVFH9.1BCP
MAIN-P.W.Board			ZD2520	48-29509Z22	DIO,ZEN UDZVFH20B-CP
MAIN-P.W.Board			ZD2530	48-29509Z09	DIO,ZEN UDZVFH5.1BCP
MAIN-P.W.Board			ZD2620	48-29509Z20	DIO,ZEN UDZVFH16B-CP
MAIN-P.W.Board			ZD2700	48-36670Z01	DIO,ZEN RSDT27NS -E9
SOC-P.W.Board			ANT4000	09-36702Z01	GT21T-1P-H -EE
SOC-P.W.Board			ANT4200	85-30932Z02	ANT,162442ST-1000-CP
SOC-P.W.Board			ANT4201	85-30932Z01	ANT,162442DT-2001-CP
SOC-P.W.Board			ANT4202	09-07494Z01	U.FL-R-SMT-1(80)-E2
SOC-P.W.Board			ANT4203	09-07494Z01	U.FL-R-SMT-1(80)-E2
SOC-P.W.Board			C3000	08-32878Z05	CAP,CER105KX7R1AQ2CP
SOC-P.W.Board			C3001	08-32878Z05	CAP,CER105KX7R1AQ2CP
SOC-P.W.Board			C3002	08-32878Z05	CAP,CER105KX7R1AQ2CP
SOC-P.W.Board			C3003	08-32878Z05	CAP,CER105KX7R1AQ2CP
SOC-P.W.Board			C3004	08-32878Z05	CAP,CER105KX7R1AQ2CP
SOC-P.W.Board			C3005	08-32878Z05	CAP,CER105KX7R1AQ2CP
SOC-P.W.Board			C3006	08-32871Z20	CAP,CER 224KX7R1A-CP
SOC-P.W.Board			C3007	08-32878Z04	CAP,CER225KX7R0JQ2CP
SOC-P.W.Board			C3008	08-32878Z04	CAP,CER225KX7R0JQ2CP
SOC-P.W.Board			C3009	08-37972Z01	CAP,CER 476KX7R0J-CP
SOC-P.W.Board			C3010	08-37972Z01	CAP,CER 476KX7R0J-CP
SOC-P.W.Board			C3011	08-37972Z01	CAP,CER 476KX7R0J-CP
SOC-P.W.Board			C3012	08-32878Z04	CAP,CER225KX7R0JQ2CP
SOC-P.W.Board			C3013	08-32878Z04	CAP,CER225KX7R0JQ2CP
SOC-P.W.Board			C3014	08-32878Z04	CAP,CER225KX7R0JQ2CP
SOC-P.W.Board			C3016	08-37972Z02	CAP,CER 226KX7R1A-CP
SOC-P.W.Board			C3017	08-37972Z02	CAP,CER 226KX7R1A-CP
SOC-P.W.Board			C3018	08-37972Z02	CAP,CER 226KX7R1A-CP
SOC-P.W.Board			C3019	08-37972Z02	CAP,CER 226KX7R1A-CP
SOC-P.W.Board			C3020	08-37972Z01	CAP,CER 476KX7R0J-CP
SOC-P.W.Board			C3021	08-37972Z01	CAP,CER 476KX7R0J-CP
SOC-P.W.Board			C3022	08-32871Z20	CAP,CER 224KX7R1A-CP
SOC-P.W.Board			C3024	08-37972Z02	CAP,CER 226KX7R1A-CP
SOC-P.W.Board			C3026	08-37972Z02	CAP,CER 226KX7R1A-CP
SOC-P.W.Board			C3028	08-37972Z02	CAP,CER 226KX7R1A-CP
SOC-P.W.Board			C3029	08-37972Z01	CAP,CER 476KX7R0J-CP
SOC-P.W.Board			C3030	08-32878Z05	CAP,CER105KX7R1AQ2CP

P.W.Board	MIS	MODEL	Ref.	Parts No.	Parts Name
SOC-P.W.Board			C3031	08-32877Z08	CAP,CER 106KX7R1A-CP
SOC-P.W.Board			C3032	08-32877Z08	CAP,CER 106KX7R1A-CP
SOC-P.W.Board			C3033	08-32877Z08	CAP,CER 106KX7R1A-CP
SOC-P.W.Board			C3034	08-37972Z01	CAP,CER 476KX7R0J-CP
SOC-P.W.Board			C3041	08-32877Z11	CAP,CER 224MX7R1H-CP
SOC-P.W.Board			C3042	08-32877Z11	CAP,CER 224MX7R1H-CP
SOC-P.W.Board			C3043	08-32877Z11	CAP,CER 224MX7R1H-CP
SOC-P.W.Board			C3044	08-32877Z11	CAP,CER 224MX7R1H-CP
SOC-P.W.Board			C3045	08-32877Z11	CAP,CER 224MX7R1H-CP
SOC-P.W.Board			C3046	08-32877Z11	CAP,CER 224MX7R1H-CP
SOC-P.W.Board			C3048	08-32877Z11	CAP,CER 224MX7R1H-CP
SOC-P.W.Board			C3049	08-32877Z11	CAP,CER 224MX7R1H-CP
SOC-P.W.Board			C3050	08-32877Z11	CAP,CER 224MX7R1H-CP
SOC-P.W.Board			C3051	08-32877Z11	CAP,CER 224MX7R1H-CP
SOC-P.W.Board			C3200	08-37793Z24	CAP,CER 104KX5R1A-CP
SOC-P.W.Board			C3201	08-37793Z24	CAP,CER 104KX5R1A-CP
SOC-P.W.Board			C3202	08-32877Z04	CAP,CER106KX7R0JQ2CP
SOC-P.W.Board			C3203	08-37972Z01	CAP,CER 476KX7R0J-CP
SOC-P.W.Board			C3204	08-37793Z24	CAP,CER 104KX5R1A-CP
SOC-P.W.Board			C3205	08-37793Z24	CAP,CER 104KX5R1A-CP
SOC-P.W.Board			C3206	08-37793Z24	CAP,CER 104KX5R1A-CP
SOC-P.W.Board			C3207	08-37793Z24	CAP,CER 104KX5R1A-CP
SOC-P.W.Board			C3208	08-37793Z24	CAP,CER 104KX5R1A-CP
SOC-P.W.Board			C3209	08-37793Z24	CAP,CER 104KX5R1A-CP
SOC-P.W.Board			C3210	08-37793Z24	CAP,CER 104KX5R1A-CP
SOC-P.W.Board			C3211	08-37793Z24	CAP,CER 104KX5R1A-CP
SOC-P.W.Board			C3212	08-37793Z24	CAP,CER 104KX5R1A-CP
SOC-P.W.Board			C3213	08-37793Z24	CAP,CER 104KX5R1A-CP
SOC-P.W.Board			C3214	08-37793Z24	CAP,CER 104KX5R1A-CP
SOC-P.W.Board			C3215	08-37793Z24	CAP,CER 104KX5R1A-CP
SOC-P.W.Board			C3216	08-37793Z24	CAP,CER 104KX5R1A-CP
SOC-P.W.Board			C3217	08-37793Z24	CAP,CER 104KX5R1A-CP
SOC-P.W.Board			C3218	08-37793Z24	CAP,CER 104KX5R1A-CP
SOC-P.W.Board			C3219	08-37793Z24	CAP,CER 104KX5R1A-CP
SOC-P.W.Board			C3220	08-37793Z24	CAP,CER 104KX5R1A-CP
SOC-P.W.Board			C3221	08-37793Z24	CAP,CER 104KX5R1A-CP
SOC-P.W.Board			C3222	08-37793Z24	CAP,CER 104KX5R1A-CP
SOC-P.W.Board			C3223	08-32877Z04	CAP,CER106KX7R0JQ2CP
SOC-P.W.Board			C3224	08-34782Z02	CAP,CER 476MX5R0G-CP
SOC-P.W.Board			C3225	08-37793Z24	CAP,CER 104KX5R1A-CP
SOC-P.W.Board			C3226	08-37793Z24	CAP,CER 104KX5R1A-CP
SOC-P.W.Board			C3227	08-37793Z24	CAP,CER 104KX5R1A-CP
SOC-P.W.Board			C3228	08-37793Z24	CAP,CER 104KX5R1A-CP
SOC-P.W.Board			C3229	08-37793Z24	CAP,CER 104KX5R1A-CP
SOC-P.W.Board			C3230	08-37793Z24	CAP,CER 104KX5R1A-CP
SOC-P.W.Board			C3231	08-32877Z04	CAP,CER106KX7R0JQ2CP
SOC-P.W.Board			C3232	08-37972Z01	CAP,CER 476KX7R0J-CP
SOC-P.W.Board			C3233	08-37793Z24	CAP,CER 104KX5R1A-CP
SOC-P.W.Board			C3234	08-37793Z24	CAP,CER 104KX5R1A-CP
SOC-P.W.Board			C3235	08-37793Z24	CAP,CER 104KX5R1A-CP
SOC-P.W.Board			C3236	08-37793Z24	CAP,CER 104KX5R1A-CP
SOC-P.W.Board			C3237	08-37793Z24	CAP,CER 104KX5R1A-CP
SOC-P.W.Board			C3238	08-32877Z04	CAP,CER106KX7R0JQ2CP
SOC-P.W.Board			C3239	08-37972Z01	CAP,CER 476KX7R0J-CP
SOC-P.W.Board			C3240	08-37793Z24	CAP,CER 104KX5R1A-CP
SOC-P.W.Board			C3241	08-37793Z24	CAP,CER 104KX5R1A-CP
SOC-P.W.Board			C3242	08-37793Z24	CAP,CER 104KX5R1A-CP
SOC-P.W.Board			C3243	08-37793Z24	CAP,CER 104KX5R1A-CP
SOC-P.W.Board			C3244	08-37793Z24	CAP,CER 104KX5R1A-CP
SOC-P.W.Board			C3245	08-32871Z13	CAP,CER 105KX7R0G-CP
SOC-P.W.Board			C3246	08-32877Z04	CAP,CER106KX7R0JQ2CP
SOC-P.W.Board			C3247	08-37972Z01	CAP,CER 476KX7R0J-CP
SOC-P.W.Board			C3248	08-37793Z24	CAP,CER 104KX5R1A-CP
SOC-P.W.Board			C3249	08-37793Z24	CAP,CER 104KX5R1A-CP
SOC-P.W.Board			C3250	08-37793Z24	CAP,CER 104KX5R1A-CP
SOC-P.W.Board			C3251	08-37793Z24	CAP,CER 104KX5R1A-CP
SOC-P.W.Board			C3252	08-37793Z24	CAP,CER 104KX5R1A-CP
SOC-P.W.Board			C3253	08-37793Z24	CAP,CER 104KX5R1A-CP
SOC-P.W.Board			C3254	08-37793Z24	CAP,CER 104KX5R1A-CP
SOC-P.W.Board			C3255	08-37793Z24	CAP,CER 104KX5R1A-CP
SOC-P.W.Board			C3256	08-37793Z24	CAP,CER 104KX5R1A-CP
SOC-P.W.Board			C3257	08-32871Z13	CAP,CER 105KX7R0G-CP
SOC-P.W.Board			C3258	08-37793Z24	CAP,CER 104KX5R1A-CP
SOC-P.W.Board			C3259	08-37793Z24	CAP,CER 104KX5R1A-CP
SOC-P.W.Board			C3260	08-32871Z13	CAP,CER 105KX7R0G-CP
SOC-P.W.Board			C3261	08-37793Z24	CAP,CER 104KX5R1A-CP
SOC-P.W.Board			C3262	08-32871Z13	CAP,CER 105KX7R0G-CP
SOC-P.W.Board			C3263	08-37793Z24	CAP,CER 104KX5R1A-CP



P.W.Board	MIS	MODEL	Ref.	Parts No.	Parts Name
SOC-P.W.Board			C3808	08-32877Z04	CAP,CER106KX7R0JQ2CP
SOC-P.W.Board			C3809	08-32861Z04	CAP,CER 226KX7R0J-CP
SOC-P.W.Board			C3810	08-37793Z24	CAP,CER 104KX5R1A-CP
SOC-P.W.Board			C3811	08-37793Z24	CAP,CER 104KX5R1A-CP
SOC-P.W.Board			C3812	08-37793Z24	CAP,CER 104KX5R1A-CP
SOC-P.W.Board			C3813	08-37793Z24	CAP,CER 104KX5R1A-CP
SOC-P.W.Board			C3814	08-37793Z24	CAP,CER 104KX5R1A-CP
SOC-P.W.Board			C3815	08-37793Z24	CAP,CER 104KX5R1A-CP
SOC-P.W.Board			C3816	08-37793Z24	CAP,CER 104KX5R1A-CP
SOC-P.W.Board			C3817	08-37793Z24	CAP,CER 104KX5R1A-CP
SOC-P.W.Board			C3818	08-37793Z24	CAP,CER 104KX5R1A-CP
SOC-P.W.Board			C3819	08-37793Z24	CAP,CER 104KX5R1A-CP
SOC-P.W.Board			C3820	08-37793Z24	CAP,CER 104KX5R1A-CP
SOC-P.W.Board			C3821	08-37793Z24	CAP,CER 104KX5R1A-CP
SOC-P.W.Board			C3822	08-37793Z24	CAP,CER 104KX5R1A-CP
SOC-P.W.Board			C3823	08-37793Z24	CAP,CER 104KX5R1A-CP
SOC-P.W.Board			C3824	08-37793Z24	CAP,CER 104KX5R1A-CP
SOC-P.W.Board			C3825	08-37793Z24	CAP,CER 104KX5R1A-CP
SOC-P.W.Board			C3826	08-37793Z24	CAP,CER 104KX5R1A-CP
SOC-P.W.Board			C3827	08-37793Z24	CAP,CER 104KX5R1A-CP
SOC-P.W.Board			C3828	08-37793Z24	CAP,CER 104KX5R1A-CP
SOC-P.W.Board			C3829	08-37793Z24	CAP,CER 104KX5R1A-CP
SOC-P.W.Board			C3830	08-37793Z24	CAP,CER 104KX5R1A-CP
SOC-P.W.Board			C3831	08-37793Z24	CAP,CER 104KX5R1A-CP
SOC-P.W.Board			C3832	08-37793Z24	CAP,CER 104KX5R1A-CP
SOC-P.W.Board			C3833	08-37793Z24	CAP,CER 104KX5R1A-CP
SOC-P.W.Board			C3834	08-32877Z04	CAP,CER106KX7R0JQ2CP
SOC-P.W.Board			C3835	08-32861Z04	CAP,CER 226KX7R0J-CP
SOC-P.W.Board			C3836	08-37793Z24	CAP,CER 104KX5R1A-CP
SOC-P.W.Board			C3837	08-37793Z24	CAP,CER 104KX5R1A-CP
SOC-P.W.Board			C3838	08-37793Z24	CAP,CER 104KX5R1A-CP
SOC-P.W.Board			C3839	08-37793Z24	CAP,CER 104KX5R1A-CP
SOC-P.W.Board			C3840	08-37793Z24	CAP,CER 104KX5R1A-CP
SOC-P.W.Board			C3841	08-37793Z24	CAP,CER 104KX5R1A-CP
SOC-P.W.Board			C3842	08-37793Z24	CAP,CER 104KX5R1A-CP
SOC-P.W.Board			C3843	08-37793Z24	CAP,CER 104KX5R1A-CP
SOC-P.W.Board			C3844	08-37793Z24	CAP,CER 104KX5R1A-CP
SOC-P.W.Board			C3845	08-37793Z24	CAP,CER 104KX5R1A-CP
SOC-P.W.Board			C3846	08-37793Z24	CAP,CER 104KX5R1A-CP
SOC-P.W.Board			C3847	08-37793Z24	CAP,CER 104KX5R1A-CP
SOC-P.W.Board			C3848	08-37793Z24	CAP,CER 104KX5R1A-CP
SOC-P.W.Board			C3849	08-37793Z24	CAP,CER 104KX5R1A-CP
SOC-P.W.Board			C3850	08-37793Z24	CAP,CER 104KX5R1A-CP
SOC-P.W.Board			C3851	08-37793Z24	CAP,CER 104KX5R1A-CP
SOC-P.W.Board			C3852	08-37793Z24	CAP,CER 104KX5R1A-CP
SOC-P.W.Board			C3853	08-37793Z24	CAP,CER 104KX5R1A-CP
SOC-P.W.Board			C3854	08-37793Z24	CAP,CER 104KX5R1A-CP
SOC-P.W.Board			C3855	08-37793Z24	CAP,CER 104KX5R1A-CP
SOC-P.W.Board			C3856	08-32861Z04	CAP,CER 226KX7R0J-CP
SOC-P.W.Board			C3857	08-32877Z04	CAP,CER106KX7R0JQ2CP
SOC-P.W.Board			C3858	08-32871Z15	CAP,CER 104KX7R0J-CP
SOC-P.W.Board			C3859	08-37793Z24	CAP,CER 104KX5R1A-CP
SOC-P.W.Board			C3860	08-32877Z03	CAP,CER475KX7R1AQ2CP
SOC-P.W.Board			C3862	08-32878Z04	CAP,CER225KX7R0JQ2CP
SOC-P.W.Board			C3863	08-37793Z24	CAP,CER 104KX5R1A-CP
SOC-P.W.Board			C3864	08-32877Z03	CAP,CER475KX7R1AQ2CP
SOC-P.W.Board			C3865	08-32878Z04	CAP,CER225KX7R0JQ2CP
SOC-P.W.Board			C4000	08-32871Z19	CAP,CER 104KX7R1A-CP
SOC-P.W.Board			C4002	08-32871Z10	CAP,CER104KX7R1CQ2CP
SOC-P.W.Board			C4004	08-32877Z08	CAP,CER 106KX7R1A-CP
SOC-P.W.Board			C4005	08-32877Z08	CAP,CER 106KX7R1A-CP
SOC-P.W.Board			C4006	08-37526Z27	CAP,CER 101J-CG1H-CP
SOC-P.W.Board			C4007	08-37526Z21	CAP,CER 33RJ-CG1H-CP
SOC-P.W.Board			C4008	08-37526Z10	CAP,CER 5R0C-CG1H-CP
SOC-P.W.Board			C4009	08-37526Z10	CAP,CER 5R0C-CG1H-CP
SOC-P.W.Board			C4010	08-32871Z10	CAP,CER104KX7R1CQ2CP
SOC-P.W.Board			C4011	08-37526Z04	CAP,CER R80B-CG1H-CP
SOC-P.W.Board			C4012	08-32871Z19	CAP,CER 104KX7R1A-CP
SOC-P.W.Board			C4200	08-37526Z01	CAP,CER R50B-CG1H-CP
SOC-P.W.Board			C4201	08-37526Z01	CAP,CER R50B-CG1H-CP
SOC-P.W.Board			C4202	08-37526Z03	CAP,CER 1R8C-CG1H-CP
SOC-P.W.Board			C4205	08-37526Z07	CAP,CER 2R0C-CG1H-CP
SOC-P.W.Board			C4207	08-37526Z06	CAP,CER 1R0C-CG1H-CP
SOC-P.W.Board			C4208	08-32877Z04	CAP,CER106KX7R0JQ2CP
SOC-P.W.Board			C4209	08-32871Z19	CAP,CER 104KX7R1A-CP
SOC-P.W.Board			C4210	08-32877Z04	CAP,CER106KX7R0JQ2CP
SOC-P.W.Board			C4211	08-32871Z19	CAP,CER 104KX7R1A-CP
SOC-P.W.Board			C4212	08-37526Z06	CAP,CER 1R0C-CG1H-CP
SOC-P.W.Board			C4400	08-37526Z18	CAP,CER 18RJ-CG1H-CP
SOC-P.W.Board			C4401	08-37526Z18	CAP,CER 18RJ-CG1H-CP
SOC-P.W.Board			C4402	08-32871Z20	CAP,CER 224KX7R1A-CP
SOC-P.W.Board			C4404	08-32861Z04	CAP,CER 226KX7R0J-CP
SOC-P.W.Board			C4405	08-32871Z19	CAP,CER 104KX7R1A-CP
SOC-P.W.Board			C4406	08-32871Z19	CAP,CER 104KX7R1A-CP
SOC-P.W.Board			C4407	08-32871Z19	CAP,CER 104KX7R1A-CP
SOC-P.W.Board			C4408	08-32871Z19	CAP,CER 104KX7R1A-CP
SOC-P.W.Board			C4409	08-32871Z07	CAP,CER103KX7R1CQ2CP
SOC-P.W.Board			C4410	08-32871Z19	CAP,CER 104KX7R1A-CP

P.W.Board	MIS	MODEL	Ref.	Parts No.	Parts Name
SOC-P.W.Board			C4411	08-32871Z07	CAP,CER103KX7R1CQ2CP
SOC-P.W.Board			C4412	08-32871Z07	CAP,CER103KX7R1CQ2CP
SOC-P.W.Board			C4413	08-32871Z19	CAP,CER 104KX7R1A-CP
SOC-P.W.Board			C4414	08-32871Z19	CAP,CER 104KX7R1A-CP
SOC-P.W.Board			C4415	08-32871Z19	CAP,CER 104KX7R1A-CP
SOC-P.W.Board			C4416	08-32871Z07	CAP,CER103KX7R1CQ2CP
SOC-P.W.Board			C4417	08-32871Z07	CAP,CER103KX7R1CQ2CP
SOC-P.W.Board			C4418	08-32871Z07	CAP,CER103KX7R1CQ2CP
SOC-P.W.Board			C4419	08-32871Z07	CAP,CER103KX7R1CQ2CP
SOC-P.W.Board			C4420	08-3287Z11	CAP,CER 105KX7R1C-CP
SOC-P.W.Board			C4421	08-3287Z07	CAP,CER 225KX7R1A-CP
SOC-P.W.Board			C4422	08-32871Z19	CAP,CER 104KX7R1A-CP
SOC-P.W.Board			C4423	08-32871Z19	CAP,CER 104KX7R1A-CP
SOC-P.W.Board			C4424	08-32871Z19	CAP,CER 104KX7R1A-CP
SOC-P.W.Board			C4425	08-3287Z11	CAP,CER 105KX7R1C-CP
SOC-P.W.Board			C4426	08-32871Z07	CAP,CER103KX7R1CQ2CP
SOC-P.W.Board			C4427	08-32871Z19	CAP,CER 104KX7R1A-CP
SOC-P.W.Board			C4428	08-32871Z19	CAP,CER 104KX7R1A-CP
SOC-P.W.Board			C4430	08-32871Z07	CAP,CER103KX7R1CQ2CP
SOC-P.W.Board			C4431	08-32871Z07	CAP,CER103KX7R1CQ2CP
SOC-P.W.Board			C4432	08-32871Z07	CAP,CER103KX7R1CQ2CP
SOC-P.W.Board			C4433	08-32871Z19	CAP,CER 104KX7R1A-CP
SOC-P.W.Board			C4434	08-32871Z19	CAP,CER 104KX7R1A-CP
SOC-P.W.Board			C4435	08-32871Z07	CAP,CER103KX7R1CQ2CP
SOC-P.W.Board			C4436	08-32871Z07	CAP,CER103KX7R1CQ2CP
SOC-P.W.Board			C4600	08-32871Z19	CAP,CER 104KX7R1A-CP
SOC-P.W.Board			C4601	08-32871Z19	CAP,CER 104KX7R1A-CP
SOC-P.W.Board			C4602	08-32871Z19	CAP,CER 104KX7R1A-CP
SOC-P.W.Board			C4603	08-32871Z07	CAP,CER103KX7R1CQ2CP
SOC-P.W.Board			C4800	08-3287Z05	CAP,CER105KX7R1AQ2CP
SOC-P.W.Board			C4801	08-3287Z05	CAP,CER105KX7R1AQ2CP
SOC-P.W.Board			C4802	08-3287Z05	CAP,CER105KX7R1AQ2CP
SOC-P.W.Board			C4803	08-3287Z04	CAP,CER106KX7R0JQ2CP
SOC-P.W.Board			C4804	08-32871Z19	CAP,CER 104KX7R1A-CP
SOC-P.W.Board			C4805	08-32871Z19	CAP,CER 104KX7R1A-CP
SOC-P.W.Board			C4806	08-3287Z09	CAP,CER 105KX7R1E-CP
SOC-P.W.Board			C4807	08-3287Z08	CAP,CER 106KX7R1A-CP
SOC-P.W.Board			C4808	08-3287Z08	CAP,CER 106KX7R1A-CP
SOC-P.W.Board			C4809	08-32871Z20	CAP,CER 224KX7R1A-CP
SOC-P.W.Board			C4810	08-32871Z20	CAP,CER 224KX7R1A-CP
SOC-P.W.Board			C4811	08-3287Z09	CAP,CER 105KX7R1E-CP
SOC-P.W.Board			C4812	08-32871Z01	CAP,CER102KX7R1HQ2CP
SOC-P.W.Board			C4813	08-32871Z01	CAP,CER102KX7R1HQ2CP
SOC-P.W.Board			C4814	08-3287Z04	CAP,CER106KX7R0JQ2CP
SOC-P.W.Board			C4815	08-32871Z19	CAP,CER 104KX7R1A-CP
SOC-P.W.Board			C4816	08-3287Z04	CAP,CER106KX7R0JQ2CP
SOC-P.W.Board			C4817	08-32871Z19	CAP,CER 104KX7R1A-CP
SOC-P.W.Board			C4818	08-32871Z19	CAP,CER 104KX7R1A-CP
SOC-P.W.Board			C4819	08-32861Z05	CAP,CER 475KX7R1E-CP
SOC-P.W.Board			C4820	08-32861Z05	CAP,CER 475KX7R1E-CP
SOC-P.W.Board			C4821	08-32861Z05	CAP,CER 475KX7R1E-CP
SOC-P.W.Board			C4822	08-32861Z05	CAP,CER 475KX7R1E-CP
SOC-P.W.Board			C4823	08-3287Z04	CAP,CER106KX7R0JQ2CP
SOC-P.W.Board			C4824	08-32871Z19	CAP,CER 104KX7R1A-CP
SOC-P.W.Board			C4825	08-3287Z04	CAP,CER106KX7R0JQ2CP
SOC-P.W.Board			C4826	08-3287Z04	CAP,CER106KX7R0JQ2CP
SOC-P.W.Board			C4827	08-32871Z19	CAP,CER 104KX7R1A-CP
SOC-P.W.Board			C4828	08-32871Z30	CAP,CER 473KX7R1E-CP
SOC-P.W.Board			C4829	08-32871Z30	CAP,CER 473KX7R1E-CP
SOC-P.W.Board			C4830	08-37526Z15	CAP,CER 10RJ-CG1H-CP
SOC-P.W.Board			C4831	08-3287Z08	CAP,CER 106KX7R1A-CP
SOC-P.W.Board			C4832	08-32871Z20	CAP,CER 224KX7R1A-CP
SOC-P.W.Board			C4833	08-32861Z05	CAP,CER 475KX7R1E-CP
SOC-P.W.Board			C4834	08-32861Z05	CAP,CER 475KX7R1E-CP
SOC-P.W.Board			C4835	08-32871Z30	CAP,CER 473KX7R1E-CP
SOC-P.W.Board			C4836	08-3287Z05	CAP,CER105KX7R1AQ2CP
SOC-P.W.Board			C4837	08-3287Z08	CAP,CER 106KX7R1A-CP
SOC-P.W.Board			C4838	08-32871Z20	CAP,CER 224KX7R1A-CP
SOC-P.W.Board			C4839	08-32861Z05	CAP,CER 475KX7R1E-CP
SOC-P.W.Board			C4840	08-32861Z05	CAP,CER 475KX7R1E-CP
SOC-P.W.Board			C4841	08-32871Z30	CAP,CER 473KX7R1E-CP
SOC-P.W.Board			C4842	08-37526Z15	CAP,CER 10RJ-CG1H-CP
SOC-P.W.Board			C5000	08-3797Z07	CAP,CER 106KX7R1H-CP
SOC-P.W.Board			C5002	08-3287Z03	CAP,CER104KX7R1HQ2CP
SOC-P.W.Board			C5003	08-3287Z04	CAP,CER225KX7R0JQ2CP
SOC-P.W.Board			C5004	08-3287Z05	CAP,CER105KX7R1AQ2CP
SOC-P.W.Board			C5005	08-3287Z03	CAP,CER104KX7R1HQ2CP
SOC-P.W.Board			C5006	08-37526Z27	CAP,CER 101J-CG1H-CP
SOC-P.W.Board			C5007	08-3282Z01	CAP,CER 1R0CCG1HQ2CP
SOC-P.W.Board			C5008	08-3282Z01	CAP,CER 1R0CCG1HQ2CP
SOC-P.W.Board			C5009	08-3287Z03	CAP,CER104KX7R1HQ2CP
SOC-P.W.Board			C5010	08-3282Z08	CAP,CER 6R0DCG1HQ2CP
SOC-P.W.Board			C5011	08-3282Z08	CAP,CER 6R0DCG1HQ2CP
SOC-P.W.Board			C5012	08-3287Z05	CAP,CER105KX7R1AQ2CP
SOC-P.W.Board			C5014	08-3797Z05	CAP,CER 226KX7R1E-CP
SOC-P.W.Board			C5015	08-3287Z11	CAP,CER 224MX7R1H-CP
SOC-P.W.Board			C5016	08-3287Z03	CAP,CER104KX7R1HQ2CP
SOC-P.W.Board			C5017	08-3287Z11	CAP,CER 224MX7R1H-CP

P.W.Board	MIS	MODEL	Ref.	Parts No.	Parts Name
SOC-P.W.Board			C5018	08-32827Z07	CAP,CER 5R0CCG1HQ2CP
SOC-P.W.Board			C5019	08-32827Z07	CAP,CER 5R0CCG1HQ2CP
SOC-P.W.Board			C5020	08-37526Z13	CAP,CER 8R0D-CG1H-CP
SOC-P.W.Board			C5021	08-32871Z15	CAP,CER 104KX7R0J-CP
SOC-P.W.Board			C5022	08-32871Z04	CAP,CER332KX7R1HQ2CP
SOC-P.W.Board			C5023	08-37526Z13	CAP,CER 8R0D-CG1H-CP
SOC-P.W.Board			C5024	08-37972Z03	CAP,CER 226KX7R1C-CP
SOC-P.W.Board			C5025	08-32877Z11	CAP,CER 224MX7R1H-CP
SOC-P.W.Board			C5026	08-32871Z19	CAP,CER 104KX7R1A-CP
SOC-P.W.Board			C5027	08-37972Z03	CAP,CER 226KX7R1C-CP
SOC-P.W.Board			C5200	08-37972Z07	CAP,CER 106KX7R1H-CP
SOC-P.W.Board			C5209	08-37972Z07	CAP,CER 106KX7R1H-CP
SOC-P.W.Board			C5210	08-32877Z11	CAP,CER 224MX7R1H-CP
SOC-P.W.Board			C5211	08-32877Z08	CAP,CER 106KX7R1A-CP
SOC-P.W.Board			C5212	08-32878Z03	CAP,CER104KX7R1HQ2CP
SOC-P.W.Board			C5214	08-32877Z11	CAP,CER 224MX7R1H-CP
SOC-P.W.Board			C5215	08-37972Z03	CAP,CER 226KX7R1C-CP
SOC-P.W.Board			C5220	08-37972Z07	CAP,CER 106KX7R1H-CP
SOC-P.W.Board			C5221	08-37972Z07	CAP,CER 106KX7R1H-CP
SOC-P.W.Board			C5222	08-32877Z11	CAP,CER 224MX7R1H-CP
SOC-P.W.Board			C5223	08-32877Z08	CAP,CER 106KX7R1A-CP
SOC-P.W.Board			C5224	08-32878Z03	CAP,CER104KX7R1HQ2CP
SOC-P.W.Board			C5226	08-32877Z11	CAP,CER 224MX7R1H-CP
SOC-P.W.Board			C5227	08-37972Z03	CAP,CER 226KX7R1C-CP
SOC-P.W.Board			C5400	08-32877Z11	CAP,CER 224MX7R1H-CP
SOC-P.W.Board			C5401	08-32877Z11	CAP,CER 224MX7R1H-CP
SOC-P.W.Board			C5402	08-32877Z04	CAP,CER106KX7R0JQ2CP
SOC-P.W.Board			C5403	08-32877Z08	CAP,CER 106KX7R1A-CP
SOC-P.W.Board			C5404	08-32877Z11	CAP,CER 224MX7R1H-CP
SOC-P.W.Board			C5405	08-32877Z11	CAP,CER 224MX7R1H-CP
SOC-P.W.Board			C5406	08-32877Z11	CAP,CER 224MX7R1H-CP
SOC-P.W.Board			C5407	08-32877Z04	CAP,CER106KX7R0JQ2CP
SOC-P.W.Board			C5408	08-32877Z11	CAP,CER 224MX7R1H-CP
SOC-P.W.Board			C5409	08-32877Z11	CAP,CER 224MX7R1H-CP
SOC-P.W.Board			C5410	08-32877Z08	CAP,CER 106KX7R1A-CP
SOC-P.W.Board			C5411	08-32877Z08	CAP,CER 106KX7R1A-CP
SOC-P.W.Board			C5412	08-32871Z22	CAP,CER 223KX7R1C-CP
SOC-P.W.Board			C5413	08-32877Z04	CAP,CER106KX7R0JQ2CP
SOC-P.W.Board			C5414	08-32877Z04	CAP,CER106KX7R0JQ2CP
SOC-P.W.Board			C5415	08-32877Z11	CAP,CER 224MX7R1H-CP
SOC-P.W.Board			C5416	08-32871Z20	CAP,CER 224KX7R1A-CP
SOC-P.W.Board			C5417	08-32877Z11	CAP,CER 224MX7R1H-CP
SOC-P.W.Board			C5418	08-32877Z11	CAP,CER 224MX7R1H-CP
SOC-P.W.Board			C5419	08-32877Z04	CAP,CER106KX7R0JQ2CP
SOC-P.W.Board			C5420	08-32877Z04	CAP,CER106KX7R0JQ2CP
SOC-P.W.Board			C5421	08-32871Z22	CAP,CER 223KX7R1C-CP
SOC-P.W.Board			C5422	08-32877Z04	CAP,CER106KX7R0JQ2CP
SOC-P.W.Board			C5423	08-32877Z04	CAP,CER106KX7R0JQ2CP
SOC-P.W.Board			C5424	08-32877Z08	CAP,CER 106KX7R1A-CP
SOC-P.W.Board			C5425	08-32877Z04	CAP,CER106KX7R0JQ2CP
SOC-P.W.Board			C5426	08-37972Z07	CAP,CER 106KX7R1H-CP
SOC-P.W.Board			C5428	08-32877Z11	CAP,CER 224MX7R1H-CP
SOC-P.W.Board			C5429	08-32877Z08	CAP,CER 106KX7R1A-CP
SOC-P.W.Board			C5430	08-32877Z11	CAP,CER 224MX7R1H-CP
SOC-P.W.Board			C5431	08-32877Z11	CAP,CER 224MX7R1H-CP
SOC-P.W.Board			C5432	08-32877Z08	CAP,CER 106KX7R1A-CP
SOC-P.W.Board			C5433	08-32877Z08	CAP,CER 106KX7R1A-CP
SOC-P.W.Board			C5434	08-32877Z11	CAP,CER 224MX7R1H-CP
SOC-P.W.Board			C5435	08-32877Z11	CAP,CER 224MX7R1H-CP
SOC-P.W.Board			C5436	08-32861Z02	CAP,CER 106KX7R1C-CP
SOC-P.W.Board			C5437	08-32877Z04	CAP,CER106KX7R0JQ2CP
SOC-P.W.Board			C5438	08-37526Z27	CAP,CER 101J-CG1H-CP
SOC-P.W.Board			C5439	08-37802Z06	CAP,CER 103KX7R1A-CP
SOC-P.W.Board			C5440	08-32877Z11	CAP,CER 224MX7R1H-CP
SOC-P.W.Board			C5441	08-32877Z11	CAP,CER 224MX7R1H-CP
SOC-P.W.Board			C5442	08-32877Z04	CAP,CER106KX7R0JQ2CP
SOC-P.W.Board			C5443	08-32871Z19	CAP,CER 104KX7R1A-CP
SOC-P.W.Board			C5445	08-32877Z11	CAP,CER 224MX7R1H-CP
SOC-P.W.Board			C5446	08-32877Z11	CAP,CER 224MX7R1H-CP
SOC-P.W.Board			C5447	08-32877Z04	CAP,CER106KX7R0JQ2CP
SOC-P.W.Board			C5448	08-32877Z08	CAP,CER 106KX7R1A-CP
SOC-P.W.Board			C5449	08-32877Z08	CAP,CER 106KX7R1A-CP
SOC-P.W.Board			C5900	08-33201Z06	CAP,CER 226MX5R1C-CP
SOC-P.W.Board			C5902	08-32871Z01	CAP,CER102KX7R1HQ2CP
SOC-P.W.Board			C5903	08-32871Z01	CAP,CER102KX7R1HQ2CP
SOC-P.W.Board			C6000	08-32871Z01	CAP,CER102KX7R1HQ2CP
SOC-P.W.Board			C6001	08-32878Z03	CAP,CER104KX7R1HQ2CP
SOC-P.W.Board			C6002	08-32827Z28	CAP,CER 331JCG1HQ2CP
SOC-P.W.Board			C6003	08-32871Z09	CAP,CER103KX7R1HQ2CP
SOC-P.W.Board			C6006	08-32827Z28	CAP,CER 331JCG1HQ2CP
SOC-P.W.Board			C6007	08-37800Z09	CAP,CER 224KX5R1A-CP
SOC-P.W.Board			C6008	08-32877Z11	CAP,CER 224MX7R1H-CP
SOC-P.W.Board			C6009	08-37526Z27	CAP,CER 101J-CG1H-CP
SOC-P.W.Board			C6010	08-37800Z09	CAP,CER 224KX5R1A-CP
SOC-P.W.Board			C6012	08-37526Z27	CAP,CER 101J-CG1H-CP
SOC-P.W.Board			C6013	08-32827Z28	CAP,CER 331JCG1HQ2CP
SOC-P.W.Board			C6014	08-32827Z28	CAP,CER 331JCG1HQ2CP
SOC-P.W.Board			C6015	08-32827Z28	CAP,CER 331JCG1HQ2CP

P.W.Board	MIS	MODEL	Ref.	Parts No.	Parts Name
SOC-P.W.Board			C6016	08-32827Z28	CAP,CER 331JCG1HQ2CP
SOC-P.W.Board			C6023	08-32878Z05	CAP,CER105KX7R1AQ2CP
SOC-P.W.Board			C6024	08-32878Z05	CAP,CER105KX7R1AQ2CP
SOC-P.W.Board			C6025	08-32871Z33	CAP,CER 223KX7R1H-CP
SOC-P.W.Board			C6026	08-32827Z25	CAP,CER 151JCG1HQ2CP
SOC-P.W.Board			C6031	08-32871Z36	CAP,CER 104KX7R1H-CP
SOC-P.W.Board			CB4400	09-25213Z01	WTB,TCX3400-011187-T
SOC-P.W.Board			CB4600	09-25213Z01	WTB,TCX3400-011187-T
SOC-P.W.Board			CB5000	09-05987Z04	WTB,BM05B-PASS-TFTEA
SOC-P.W.Board			CB5001	09-05987Z01	WTB,BM04B-PASS-TFTEA
SOC-P.W.Board			CB5601	09-29915Z04	FFC,50FHH-SM1-GAN-EQ
SOC-P.W.Board			CB5800	09-42336Z01	BTB,DT11-140S-20 -EZ
SOC-P.W.Board			CB5900	09-01488Z12	WTB,SM04B-GHS-TB -E5
SOC-P.W.Board			CB6000	09-38369Z03	WTB,SM22B-PUDK-D -EK
SOC-P.W.Board			D4600	48-40403Z01	VST,AVRL101D3R3FT-CP
SOC-P.W.Board			D4601	48-40403Z01	VST,AVRL101D3R3FT-CP
SOC-P.W.Board			D4602	48-40403Z01	VST,AVRL101D3R3FT-CP
SOC-P.W.Board			D5001	48-40403Z01	VST,AVRL101D3R3FT-CP
SOC-P.W.Board			D5002	48-40403Z01	VST,AVRL101D3R3FT-CP
SOC-P.W.Board			D5003	48-40403Z01	VST,AVRL101D3R3FT-CP
SOC-P.W.Board			D5004	48-40403Z01	VST,AVRL101D3R3FT-CP
SOC-P.W.Board			D5200	48-36691Z01	DIO,1SS301 -CP
SOC-P.W.Board			D6004	48-37040Z01	DIO,1SS302A -CP
SOC-P.W.Board			D6005	48-37180Z01	DIO,RR1LAM4STFTR -E1
SOC-P.W.Board			D6006	48-36817Z01	DIO,1SS352,H3XGF -CP
SOC-P.W.Board			D6007	48-37040Z01	DIO,1SS302A -CP
SOC-P.W.Board			D6008	48-37040Z01	DIO,1SS302A -CP
SOC-P.W.Board			E5000	23S75244Y36	CAP,ELY 47R-1V -E6
SOC-P.W.Board			E5401	23S75244Y18	CAP,ELY 47R-1C -E3
SOC-P.W.Board			E5402	23S75244Y38	CAP,ELY 221-1V -EA
SOC-P.W.Board			E5800	23S75244Y37	CAP,ELY 101-1V -E6
SOC-P.W.Board			F5400	65-33010Z05	FUSE,ERBRD 4A -CP
SOC-P.W.Board			IC3000	51-40887Z02	DA9063L-XXH01-AT -BT
SOC-P.W.Board			IC3200	51-40157Z01	TCC8034-0AX-I -BT
SOC-P.W.Board			IC3400	51-44405Z01	TPS3808G33QDBVRQ1-CP
SOC-P.W.Board			IC3401	51T15185Y03	TC7SH08FU,LJ -CP
SOC-P.W.Board			IC3402	51-16328Z02	TC7SH17FU,LJ -CP
SOC-P.W.Board			IC3800	51-42654Z01	H54G56BYVX046 -BT
SOC-P.W.Board			IC3820	51-42249Z01	W25Q64JVS8BQ -ST
SOC-P.W.Board			IC3820	83-43721Z85	US RL00035A RL00036A RL00037A NOR
SOC-P.W.Board			IC3840	51-34725Z02	H26M41208HPRN -BT
SOC-P.W.Board			IC3840	83-48737Z71	US RL00035A RL00036A RL00037A eMMC 8G
SOC-P.W.Board			IC4000	51-39106Z01	CA0027AN -CE1
SOC-P.W.Board			IC4200	51-42241Z01	LBEQ6ZZ1CL -EEK
SOC-P.W.Board			IC4400	51-28843Z01	ADV7611WBSWZ-RL -QEA
SOC-P.W.Board			IC4600	51-31856Z01	TC7WBP9306FK -CP
SOC-P.W.Board			IC4800	51-18961Z03	ML86V7665TB20MX -QT
SOC-P.W.Board			IC4801	51-12745Z01	BH7073G-TR -CP
SOC-P.W.Board			IC4802	51-12745Z01	BH7073G-TR -CP
SOC-P.W.Board			IC4803	51-12745Z01	BH7073G-TR -CP
SOC-P.W.Board			IC4804	51-12745Z01	BH7073G-TR -CP
SOC-P.W.Board			IC5000	51-36729Z02	MAX20037ATIC/V+ -LE2
SOC-P.W.Board			IC5001	51-32919Z01	NJM2816GM151ATE2-SE2
SOC-P.W.Board			IC5002	51-39835Z01	MF1343S00177 -CP
SOC-P.W.Board			IC5201	51-36700Z01	RTQ2104BGSP-QA -SE2
SOC-P.W.Board			IC5202	51-36700Z01	RTQ2104BGSP-QA -SE2
SOC-P.W.Board			IC5400	51-35209Z01	R1524S033B-E2-AE-SE2
SOC-P.W.Board			IC5401	51-23593Z04	BD00GA5EEFJ-ME2 -SE2
SOC-P.W.Board			IC5402	51-33825Z05	NJM12884U2-05-TE1NE2
SOC-P.W.Board			IC5403	51-33703Z02	NJM12888F15-TE1 -CP
SOC-P.W.Board			IC5404	51-23593Z05	BD00IA5EEFJ-ME2 -SE2
SOC-P.W.Board			IC5406	51-28614Z01	BD00FC0EEFJ-ME2 -SE2
SOC-P.W.Board			IC5408	51-37801Z01	NJM11100F1-TE2 -CP
SOC-P.W.Board			IC5409	51-35209Z03	R1524S018B-E2-AE-SE2
SOC-P.W.Board			IC5410	51-19576Z01	TPD1052F-TE85L -CP
SOC-P.W.Board			IC6000	51T15192Y03	74VHC14FT-EL -SE2
SOC-P.W.Board			IC6001	51T25183Y04	TC7SET08FU,LJ -CP
SOC-P.W.Board			IC6002	51T93332F02	NJM2903V-TE2 -SE2
SOC-P.W.Board			IC6003	51-36672Z01	TJA1027T/20/1 -SE2
SOC-P.W.Board			IC6005	51T15185Y03	TC7SH08FU,LJ -CP
SOC-P.W.Board			JK4800	09-12459Z01	JAC,HSJ1765-011070EA
SOC-P.W.Board			L3000	24-31696Z01	IND,DFE252012P1ROMCP
SOC-P.W.Board			L3001	24-31696Z01	IND,DFE252012P1ROMCP
SOC-P.W.Board			L3002	24-31696Z01	IND,DFE252012P1ROMCP
SOC-P.W.Board			L3003	24-31696Z01	IND,DFE252012P1ROMCP
SOC-P.W.Board			L3004	24-31696Z01	IND,DFE252012P1ROMCP
SOC-P.W.Board			L3005	24-31696Z01	IND,DFE252012P1ROMCP
SOC-P.W.Board			L3200	24-40402Z04	FBI,BLM18PG471SZ1-CP
SOC-P.W.Board			L3201	24-40402Z04	FBI,BLM18PG471SZ1-CP
SOC-P.W.Board			L3202	24-40402Z04	FBI,BLM18PG471SZ1-CP
SOC-P.W.Board			L3203	24-40402Z01	FBI,BLM18PG121SZ1-CP
SOC-P.W.Board			L3204	24-40402Z01	FBI,BLM18PG121SZ1-CP
SOC-P.W.Board			L3600	24-39836Z13	FBI,BLM15BD102SZ1-CP
SOC-P.W.Board			L3625	24-39836Z13	FBI,BLM15BD102SZ1-CP
SOC-P.W.Board			L4000	24-38378Z10	IND,LQG15HZ R0056SCP
SOC-P.W.Board			L4001	24-38378Z20	IND,LQG15HZ R039J-CP
SOC-P.W.Board			L4002	24-38378Z12	IND,LQG15HZ R0082JCP
SOC-P.W.Board			L4201	24-40402Z01	FBI,BLM18PG121SZ1-CP

P.W.Board	MIS	MODEL	Ref.	Parts No.	Parts Name
SOC-P.W.Board			L4202	24-38378Z04	IND,LQG15HZ R0018SCP
SOC-P.W.Board			L4400	24-39836Z06	FBI,BLM15BB220SZ1-CP
SOC-P.W.Board			L4401	24-39836Z06	FBI,BLM15BB220SZ1-CP
SOC-P.W.Board			L4402	24-39836Z06	FBI,BLM15BB220SZ1-CP
SOC-P.W.Board			L4403	24-39836Z06	FBI,BLM15BB220SZ1-CP
SOC-P.W.Board			L4404	24-39836Z06	FBI,BLM15BB220SZ1-CP
SOC-P.W.Board			L4800	24-40402Z02	FBI,BLM18PG181SZ1-CP
SOC-P.W.Board			L4801	24-39836Z12	FBI,BLM15BD601SZ1-CP
SOC-P.W.Board			L4802	24-39836Z10	FBI,BLM15BB221SZ1-CP
SOC-P.W.Board			L4803	24-39836Z12	FBI,BLM15BD601SZ1-CP
SOC-P.W.Board			L4804	24-39836Z12	FBI,BLM15BD601SZ1-CP
SOC-P.W.Board			L4805	24-39836Z09	FBI,BLM15BD121SZ1-CP
SOC-P.W.Board			L5000	24-28238Z02	FBI,FBJ3216HS480-CP
SOC-P.W.Board			L5002	24-38378Z09	IND,LQG15HZ R0047SCP
SOC-P.W.Board			L5003	24-38378Z09	IND,LQG15HZ R0047SCP
SOC-P.W.Board			L5004	24-38378Z15	IND,LQG15HZ R015J-CP
SOC-P.W.Board			L5005	24-38378Z15	IND,LQG15HZ R015J-CP
SOC-P.W.Board			L5006	24-31657Z01	IND,FDS0420D 1R0ME2
SOC-P.W.Board			L5007	24-38378Z17	IND,LQG15HZ R022J-CP
SOC-P.W.Board			L5008	24-38378Z17	IND,LQG15HZ R022J-CP
SOC-P.W.Board			L5200	24T95457W18	FBI,BLM21PG221SH1-CP
SOC-P.W.Board			L5203	24T95457W18	FBI,BLM21PG221SH1-CP
SOC-P.W.Board			L5204	24-31696Z03	IND,DFE252012P1R5MCP
SOC-P.W.Board			L5205	24-31657Z01	IND,FDS0420D 1R0ME2
SOC-P.W.Board			L6000	24T95456W31	FBI,BLM18PG471SH1-CP
SOC-P.W.Board			PS6000	48-16589Z03	POLY,SW SMDC150F -E2
SOC-P.W.Board			Q3000	48-28871Z02	TR,RN4982-TE85L -CP
SOC-P.W.Board			Q3001	48-28871Z02	TR,RN4982-TE85L -CP
SOC-P.W.Board			Q3002	48-42541Z01	TR,2SC6135 -CP
SOC-P.W.Board			Q3003	48-42541Z01	TR,2SC6135 -CP
SOC-P.W.Board			Q3004	48-28871Z02	TR,RN4982-TE85L -CP
SOC-P.W.Board			Q3005	48-37059Z01	TR,2SC4116-GR -CP
SOC-P.W.Board			Q3400	48-28871Z02	TR,RN4982-TE85L -CP
SOC-P.W.Board			Q4000	48-37066Z01	TR,RN1102MFV -CP
SOC-P.W.Board			Q4400	48-28871Z02	TR,RN4982-TE85L -CP
SOC-P.W.Board			Q4600	48-28871Z02	TR,RN4982-TE85L -CP
SOC-P.W.Board			Q4601	48-28871Z02	TR,RN4982-TE85L -CP
SOC-P.W.Board			Q6001	48-37059Z01	TR,2SC4116-GR -CP
SOC-P.W.Board			Q6005	48-37066Z01	TR,RN1102MFV -CP
SOC-P.W.Board			Q6006	48-37059Z01	TR,2SC4116-GR -CP
SOC-P.W.Board			R3001	06S15615Y73	RES,RK 103J 1/16 -CP
SOC-P.W.Board			R3002	06S15615Y73	RES,RK 103J 1/16 -CP
SOC-P.W.Board			R3003	06S15615Y73	RES,RK 103J 1/16 -CP
SOC-P.W.Board			R3004	06S15615Y73	RES,RK 103J 1/16 -CP
SOC-P.W.Board			R3005	06-38173Z27	RES,RK 12RJ 1/4 -CP
SOC-P.W.Board			R3007	06S15615Y73	RES,RK 103J 1/16 -CP
SOC-P.W.Board			R3008	06S15615Y73	RES,RK 103J 1/16 -CP
SOC-P.W.Board			R3012	06-38173Z43	RES,RK 56RJ 1/4 -CP
SOC-P.W.Board			R3013	06S15615Y73	RES,RK 103J 1/16 -CP
SOC-P.W.Board			R3014	06S15615Y73	RES,RK 103J 1/16 -CP
SOC-P.W.Board			R3015	06S15615Y73	RES,RK 103J 1/16 -CP
SOC-P.W.Board			R3016	06S15615Y73	RES,RK 103J 1/16 -CP
SOC-P.W.Board			R3017	06S15615Y73	RES,RK 103J 1/16 -CP
SOC-P.W.Board			R3018	06S15615Y73	RES,RK 103J 1/16 -CP
SOC-P.W.Board			R3019	06S15615Y73	RES,RK 103J 1/16 -CP
SOC-P.W.Board			R3020	06S15616Y23	RES,RK JUMPER1/16-CP
SOC-P.W.Board			R3021	06S15615Y73	RES,RK 103J 1/16 -CP
SOC-P.W.Board			R3023	06S15615Y73	RES,RK 103J 1/16 -CP
SOC-P.W.Board			R3024	06S15615Y73	RES,RK 103J 1/16 -CP
SOC-P.W.Board			R3025	06S15615Y73	RES,RK 103J 1/16 -CP
SOC-P.W.Board			R3026	06-25919Z18	RES,RK 204F 1/16 -CP
SOC-P.W.Board			R3027	06S15615Y73	RES,RK 103J 1/16 -CP
SOC-P.W.Board			R3029	06-38173Z43	RES,RK 56RJ 1/4 -CP
SOC-P.W.Board			R3030	06S15615Y73	RES,RK 103J 1/16 -CP
SOC-P.W.Board			R3032	06S15615Y73	RES,RK 103J 1/16 -CP
SOC-P.W.Board			R3033	06-38173Z43	RES,RK 56RJ 1/4 -CP
SOC-P.W.Board			R3034	06-25919Z07	RES,RK 243F 1/16 -CP
SOC-P.W.Board			R3035	06S65415Y35	RES,RK 682F 1/16 -CP
SOC-P.W.Board			R3036	06S15615Y73	RES,RK 103J 1/16 -CP
SOC-P.W.Board			R3037	06S15615Y49	RES,RK 102J 1/16 -CP
SOC-P.W.Board			R3038	06S65415Y59	RES,RK 684F 1/16 -CP
SOC-P.W.Board			R3039	06-25919Z11	RES,RK 513F 1/16 -CP
SOC-P.W.Board			R3040	06-38173Z23	RES,RK 8R2J 1/4 -CP
SOC-P.W.Board			R3041	06-38173Z23	RES,RK 8R2J 1/4 -CP
SOC-P.W.Board			R3042	06S65415Y66	RES,RK 622F 1/16 -CP
SOC-P.W.Board			R3043	06-25919Z11	RES,RK 513F 1/16 -CP
SOC-P.W.Board			R3044	06-38173Z23	RES,RK 8R2J 1/4 -CP
SOC-P.W.Board			R3045	06S15615Y73	RES,RK 103J 1/16 -CP
SOC-P.W.Board			R3046	06-25919Z01	RES,RK 752F 1/16 -CP
SOC-P.W.Board			R3047	06-25919Z15	RES,RK 114F 1/16 -CP
SOC-P.W.Board			R3048	06S15615Y41	RES,RK 471J 1/16 -CP
SOC-P.W.Board			R3049	06S15615Y73	RES,RK 103J 1/16 -CP
SOC-P.W.Board			R3050	06S65415Y50	RES,RK 124F 1/16 -CP
SOC-P.W.Board			R3051	06S65415Y48	RES,RK 823F 1/16 -CP
SOC-P.W.Board			R3052	06S15615Y49	RES,RK 102J 1/16 -CP
SOC-P.W.Board			R3054	06-25919Z13	RES,RK 753F 1/16 -CP
SOC-P.W.Board			R3055	06S65415Y66	RES,RK 622F 1/16 -CP
SOC-P.W.Board			R3062	06-25919Z15	RES,RK 114F 1/16 -CP

P.W.Board	MIS	MODEL	Ref.	Parts No.	Parts Name
SOC-P.W.Board			R3063	06S65415Y99	RES,RK 512F 1/16 -CP
SOC-P.W.Board			R3066	06S65415Y47	RES,RK 683F 1/16 -CP
SOC-P.W.Board			R3067	06S65415Y33	RES,RK 472F 1/16 -CP
SOC-P.W.Board			R3070	06S65415Y34	RES,RK 562F 1/16 -CP
SOC-P.W.Board			R3071	06S65415Y51	RES,RK 154F 1/16 -CP
SOC-P.W.Board			R3074	06S65415Y41	RES,RK 223F 1/16 -CP
SOC-P.W.Board			R3075	06S65415Y35	RES,RK 682F 1/16 -CP
SOC-P.W.Board			R3229	06S15616Y23	RES,RK JUMPER1/16-CP
SOC-P.W.Board			R3230	06S15616Y23	RES,RK JUMPER1/16-CP
SOC-P.W.Board			R3400	06S15615Y73	RES,RK 103J 1/16 -CP
SOC-P.W.Board			R3401	06S15615Y73	RES,RK 103J 1/16 -CP
SOC-P.W.Board			R3402	06S15615Y73	RES,RK 103J 1/16 -CP
SOC-P.W.Board			R3403	06S15615Y73	RES,RK 103J 1/16 -CP
SOC-P.W.Board			R3404	06S15615Y65	RES,RK 472J 1/16 -CP
SOC-P.W.Board			R3405	06S15615Y65	RES,RK 472J 1/16 -CP
SOC-P.W.Board			R3406	06S15615Y65	RES,RK 472J 1/16 -CP
SOC-P.W.Board			R3407	06S15615Y65	RES,RK 472J 1/16 -CP
SOC-P.W.Board			R3411	06S15594Y15	RES,RK 514F 1/10 -CP
SOC-P.W.Board			R3413	06S15615Y49	RES,RK 102J 1/16 -CP
SOC-P.W.Board			R3415	06S15615Y65	RES,RK 472J 1/16 -CP
SOC-P.W.Board			R3418	06S15615Y65	RES,RK 472J 1/16 -CP
SOC-P.W.Board			R3420	06S15615Y65	RES,RK 472J 1/16 -CP
SOC-P.W.Board			R3421	06S15615Y65	RES,RK 472J 1/16 -CP
SOC-P.W.Board			R3423	06S15615Y65	RES,RK 472J 1/16 -CP
SOC-P.W.Board			R3424	06S65415Y49	RES,RK 104F 1/16 -CP
SOC-P.W.Board			R3425	06S15615Y65	RES,RK 472J 1/16 -CP
SOC-P.W.Board			R3429	06S15615Y49	RES,RK 102J 1/16 -CP
SOC-P.W.Board			R3430	06S15615Y65	RES,RK 472J 1/16 -CP
SOC-P.W.Board			R3431	06S15616Y23	RES,RK JUMPER1/16-CP
SOC-P.W.Board			R3433	06S15616Y23	RES,RK JUMPER1/16-CP
SOC-P.W.Board			R3438	06S15615Y81	RES,RK 223J 1/16 -CP
SOC-P.W.Board			R3439	06S15615Y81	RES,RK 223J 1/16 -CP
SOC-P.W.Board			R3440	06S15615Y49	RES,RK 102J 1/16 -CP
SOC-P.W.Board			R3447	06S15616Y23	RES,RK JUMPER1/16-CP
SOC-P.W.Board			R3448	06S15616Y23	RES,RK JUMPER1/16-CP
SOC-P.W.Board			R3449	06S15616Y23	RES,RK JUMPER1/16-CP
SOC-P.W.Board			R3450	06S15616Y23	RES,RK JUMPER1/16-CP
SOC-P.W.Board			R3454	06S65415Y25	RES,RK 102F 1/16 -CP
SOC-P.W.Board			R3455	06S65415Y25	RES,RK 102F 1/16 -CP
SOC-P.W.Board			R3456	06S65415Y25	RES,RK 102F 1/16 -CP
SOC-P.W.Board			R3472	06S65415Y37	RES,RK 103F 1/16 -CP
SOC-P.W.Board			R3473	06S65415Y37	RES,RK 103F 1/16 -CP
SOC-P.W.Board			R3483	06S15615Y81	RES,RK 223J 1/16 -CP
SOC-P.W.Board			R3485	06S15615Y81	RES,RK 223J 1/16 -CP
SOC-P.W.Board			R3492	06S15615Y73	RES,RK 103J 1/16 -CP
SOC-P.W.Board			R3493	06S15616Y23	RES,RK JUMPER1/16-CP
SOC-P.W.Board			R3495	06S15615Y49	RES,RK 102J 1/16 -CP
SOC-P.W.Board			R3496	06S15616Y23	RES,RK JUMPER1/16-CP
SOC-P.W.Board			R3502	06S15615Y81	RES,RK 223J 1/16 -CP
SOC-P.W.Board			R3504	06S15615Y49	RES,RK 102J 1/16 -CP
SOC-P.W.Board			R3510	06S15615Y21	RES,RK 68RJ 1/16 -CP
SOC-P.W.Board			R3512	06S15616Y23	RES,RK JUMPER1/16-CP
SOC-P.W.Board			R3513	06S15615Y49	RES,RK 102J 1/16 -CP
SOC-P.W.Board			R3523	06S15615Y57	RES,RK 222J 1/16 -CP
SOC-P.W.Board			R3524	06S15615Y57	RES,RK 222J 1/16 -CP
SOC-P.W.Board			R3532	06S15615Y25	RES,RK 101J 1/16 -CP
SOC-P.W.Board			R3536	06S15615Y57	RES,RK 222J 1/16 -CP
SOC-P.W.Board			R3539	06S15616Y23	RES,RK JUMPER1/16-CP
SOC-P.W.Board			R3540	06S15616Y23	RES,RK JUMPER1/16-CP
SOC-P.W.Board			R3541	06S15616Y23	RES,RK JUMPER1/16-CP
SOC-P.W.Board			R3557	06S15615Y25	RES,RK 101J 1/16 -CP
SOC-P.W.Board			R3564	06S15615Y25	RES,RK 101J 1/16 -CP
SOC-P.W.Board			R3586	06S15616Y23	RES,RK JUMPER1/16-CP
SOC-P.W.Board			R3587	06S15616Y23	RES,RK JUMPER1/16-CP
SOC-P.W.Board			R3594	06S15616Y23	RES,RK JUMPER1/16-CP
SOC-P.W.Board			R3596	06S15616Y23	RES,RK JUMPER1/16-CP
SOC-P.W.Board			R3597	06S15616Y23	RES,RK JUMPER1/16-CP
SOC-P.W.Board			R3600	06S15616Y23	RES,RK JUMPER1/16-CP
SOC-P.W.Board			R3605	06-25919Z08	RES,RK 303F 1/16 -CP
SOC-P.W.Board			R3608	06S65415Y84	RES,RK 201F 1/16 -CP
SOC-P.W.Board			R3609	06-25919Z08	RES,RK 303F 1/16 -CP
SOC-P.W.Board			R3610	06S65415Y84	RES,RK 201F 1/16 -CP
SOC-P.W.Board			R3612	06S15615Y01	RES,RK 10RJ 1/16 -CP
SOC-P.W.Board			R3625	06S15615Y25	RES,RK 101J 1/16 -CP
SOC-P.W.Board			R3630	06S15615Y09	RES,RK 22RJ 1/16 -CP
SOC-P.W.Board			R3631	06S15615Y81	RES,RK 223J 1/16 -CP
SOC-P.W.Board			R3634	06S15615Y57	RES,RK 222J 1/16 -CP
SOC-P.W.Board			R3636	06S65415Y37	RES,RK 103F 1/16 -CP
SOC-P.W.Board			R3638	06S65415Y85	RES,RK 241F 1/16 -CP
SOC-P.W.Board			R3639	06S65415Y85	RES,RK 241F 1/16 -CP
SOC-P.W.Board			R3641	06S65415Y36	RES,RK 822F 1/16 -CP
SOC-P.W.Board			R3643	06S15615Y27	RES,RK 121J 1/16 -CP
SOC-P.W.Board			R3644	06S15615Y27	RES,RK 121J 1/16 -CP
SOC-P.W.Board			R3651	06S15616Y23	RES,RK JUMPER1/16-CP
SOC-P.W.Board			R3659	06S15616Y23	RES,RK JUMPER1/16-CP
SOC-P.W.Board			R3660	06S65415Y37	RES,RK 103F 1/16 -CP
SOC-P.W.Board			R3682	06S15615Y81	RES,RK 223J 1/16 -CP
SOC-P.W.Board			R3684	06S15615Y57	RES,RK 222J 1/16 -CP

P.W.Board	MIS	MODEL	Ref.	Parts No.	Parts Name
SOC-P.W.Board			R3686	06S15615Y25	RES,RK 101J 1/16 -CP
SOC-P.W.Board			R3687	06S15615Y25	RES,RK 101J 1/16 -CP
SOC-P.W.Board			R3692	06S15615Y65	RES,RK 472J 1/16 -CP
SOC-P.W.Board			R3698	06S15615Y81	RES,RK 223J 1/16 -CP
SOC-P.W.Board			R3701	06S15615Y81	RES,RK 223J 1/16 -CP
SOC-P.W.Board			R3702	06S15615Y81	RES,RK 223J 1/16 -CP
SOC-P.W.Board			R3703	06S15615Y81	RES,RK 223J 1/16 -CP
SOC-P.W.Board			R3705	06S15615Y81	RES,RK 223J 1/16 -CP
SOC-P.W.Board			R3706	06S15615Y81	RES,RK 223J 1/16 -CP
SOC-P.W.Board			R3707	06S15615Y81	RES,RK 223J 1/16 -CP
SOC-P.W.Board			R3708	06S15615Y81	RES,RK 223J 1/16 -CP
SOC-P.W.Board			R3717	06S15615Y57	RES,RK 222J 1/16 -CP
SOC-P.W.Board			R3719	06S15615Y57	RES,RK 222J 1/16 -CP
SOC-P.W.Board			R3720	06S15615Y81	RES,RK 223J 1/16 -CP
SOC-P.W.Board			R3725	06S15615Y57	RES,RK 222J 1/16 -CP
SOC-P.W.Board			R3726	06S15615Y81	RES,RK 223J 1/16 -CP
SOC-P.W.Board			R3727	06S15615Y57	RES,RK 222J 1/16 -CP
SOC-P.W.Board			R3800	06S65415Y85	RES,RK 241F 1/16 -CP
SOC-P.W.Board			R3801	06S65415Y85	RES,RK 241F 1/16 -CP
SOC-P.W.Board			R3802	06S65415Y37	RES,RK 103F 1/16 -CP
SOC-P.W.Board			R3803	06S15616Y23	RES,RK JUMPER1/16-CP
SOC-P.W.Board			R3806	06S65415Y37	RES,RK 103F 1/16 -CP
SOC-P.W.Board			R3808	06S65415Y37	RES,RK 103F 1/16 -CP
SOC-P.W.Board			R3809	06S15616Y23	RES,RK JUMPER1/16-CP
SOC-P.W.Board			R3811	06S65415Y37	RES,RK 103F 1/16 -CP
SOC-P.W.Board			R3812	06S65415Y37	RES,RK 103F 1/16 -CP
SOC-P.W.Board			R3820	06S15615Y09	RES,RK 22RJ 1/16 -CP
SOC-P.W.Board			R3821	06S15615Y09	RES,RK 22RJ 1/16 -CP
SOC-P.W.Board			R3822	06S15615Y23	RES,RK 82RJ 1/16 -CP
SOC-P.W.Board			R3823	06S15615Y09	RES,RK 22RJ 1/16 -CP
SOC-P.W.Board			R3828	06S15615Y57	RES,RK 222J 1/16 -CP
SOC-P.W.Board			R3829	06S15615Y09	RES,RK 22RJ 1/16 -CP
SOC-P.W.Board			R3830	06S15615Y09	RES,RK 22RJ 1/16 -CP
SOC-P.W.Board			R3840	06-02713Z16	RES,RK 103D 1/16 -CP
SOC-P.W.Board			R3841	06-02713Z16	RES,RK 103D 1/16 -CP
SOC-P.W.Board			R3842	06-02713Z16	RES,RK 103D 1/16 -CP
SOC-P.W.Board			R3843	06-02713Z16	RES,RK 103D 1/16 -CP
SOC-P.W.Board			R3844	06-02713Z16	RES,RK 103D 1/16 -CP
SOC-P.W.Board			R3845	06-02713Z16	RES,RK 103D 1/16 -CP
SOC-P.W.Board			R3846	06-02713Z16	RES,RK 103D 1/16 -CP
SOC-P.W.Board			R3847	06-02713Z16	RES,RK 103D 1/16 -CP
SOC-P.W.Board			R3848	06-02713Z16	RES,RK 103D 1/16 -CP
SOC-P.W.Board			R3849	06-02713Z16	RES,RK 103D 1/16 -CP
SOC-P.W.Board			R3851	06S15615Y11	RES,RK 27RJ 1/16 -CP
SOC-P.W.Board			R4009	06S15615Y73	RES,RK 103J 1/16 -CP
SOC-P.W.Board			R4011	06S15615Y25	RES,RK 101J 1/16 -CP
SOC-P.W.Board			R4016	06S15615Y57	RES,RK 222J 1/16 -CP
SOC-P.W.Board			R4017	06S15615Y57	RES,RK 222J 1/16 -CP
SOC-P.W.Board			R4200	06S15616Y23	RES,RK JUMPER1/16-CP
SOC-P.W.Board			R4201	06S15615Y81	RES,RK 223J 1/16 -CP
SOC-P.W.Board			R4202	06S15615Y81	RES,RK 223J 1/16 -CP
SOC-P.W.Board			R4203	06S15615Y27	RES,RK 121J 1/16 -CP
SOC-P.W.Board			R4204	06S15615Y27	RES,RK 121J 1/16 -CP
SOC-P.W.Board			R4205	06S15615Y09	RES,RK 22RJ 1/16 -CP
SOC-P.W.Board			R4206	06S15615Y09	RES,RK 22RJ 1/16 -CP
SOC-P.W.Board			R4207	06S15615Y09	RES,RK 22RJ 1/16 -CP
SOC-P.W.Board			R4208	06S15615Y09	RES,RK 22RJ 1/16 -CP
SOC-P.W.Board			R4209	06S15615Y09	RES,RK 22RJ 1/16 -CP
SOC-P.W.Board			R4214	06S15615Y57	RES,RK 222J 1/16 -CP
SOC-P.W.Board			R4215	06S15615Y65	RES,RK 472J 1/16 -CP
SOC-P.W.Board			R4216	06S15615Y65	RES,RK 472J 1/16 -CP
SOC-P.W.Board			R4217	06S15615Y65	RES,RK 472J 1/16 -CP
SOC-P.W.Board			R4218	06S15615Y65	RES,RK 472J 1/16 -CP
SOC-P.W.Board			R4219	06S15615Y65	RES,RK 472J 1/16 -CP
SOC-P.W.Board			R4220	06S15616Y23	RES,RK JUMPER1/16-CP
SOC-P.W.Board			R4400	06S15615Y13	RES,RK 33RJ 1/16 -CP
SOC-P.W.Board			R4401	06S15615Y13	RES,RK 33RJ 1/16 -CP
SOC-P.W.Board			R4402	06S15615Y13	RES,RK 33RJ 1/16 -CP
SOC-P.W.Board			R4403	06S15615Y13	RES,RK 33RJ 1/16 -CP
SOC-P.W.Board			R4404	06S15615Y13	RES,RK 33RJ 1/16 -CP
SOC-P.W.Board			R4405	06S15615Y13	RES,RK 33RJ 1/16 -CP
SOC-P.W.Board			R4406	06S15615Y13	RES,RK 33RJ 1/16 -CP
SOC-P.W.Board			R4407	06S15615Y13	RES,RK 33RJ 1/16 -CP
SOC-P.W.Board			R4408	06S15615Y13	RES,RK 33RJ 1/16 -CP
SOC-P.W.Board			R4409	06S15615Y13	RES,RK 33RJ 1/16 -CP
SOC-P.W.Board			R4410	06S15615Y13	RES,RK 33RJ 1/16 -CP
SOC-P.W.Board			R4411	06S15615Y13	RES,RK 33RJ 1/16 -CP
SOC-P.W.Board			R4412	06S15615Y13	RES,RK 33RJ 1/16 -CP
SOC-P.W.Board			R4413	06S15615Y13	RES,RK 33RJ 1/16 -CP
SOC-P.W.Board			R4414	06S15615Y13	RES,RK 33RJ 1/16 -CP
SOC-P.W.Board			R4415	06S15615Y13	RES,RK 33RJ 1/16 -CP
SOC-P.W.Board			R4416	06S15615Y13	RES,RK 33RJ 1/16 -CP
SOC-P.W.Board			R4417	06S15615Y13	RES,RK 33RJ 1/16 -CP
SOC-P.W.Board			R4418	06S15615Y09	RES,RK 22RJ 1/16 -CP
SOC-P.W.Board			R4422	06S15615Y17	RES,RK 47RJ 1/16 -CP
SOC-P.W.Board			R4423	06S15615Y17	RES,RK 47RJ 1/16 -CP
SOC-P.W.Board			R4424	06S15615Y17	RES,RK 47RJ 1/16 -CP
SOC-P.W.Board			R4426	06-38173Z49	RES,RK 101J 1/4 -CP

P.W.Board	MIS	MODEL	Ref.	Parts No.	Parts Name
SOC-P.W.Board			R4427	06-38173Z49	RES,RK 101J 1/4 -CP
SOC-P.W.Board			R4429	06S15615Y41	RES,RK 471J 1/16 -CP
SOC-P.W.Board			R4430	06-38173Z73	RES,RK 102J 1/4 -CP
SOC-P.W.Board			R4431	06S45674W89	RES,RK 223J 1/10 -CP
SOC-P.W.Board			R4433	06S45674W97	RES,RK 473J 1/10 -CP
SOC-P.W.Board			R4436	06S15615Y57	RES,RK 222J 1/16 -CP
SOC-P.W.Board			R4437	06S15615Y57	RES,RK 222J 1/16 -CP
SOC-P.W.Board			R4440	06S15615Y13	RES,RK 33RJ 1/16 -CP
SOC-P.W.Board			R4442	06S15615Y73	RES,RK 103J 1/16 -CP
SOC-P.W.Board			R4443	06S15615Y17	RES,RK 47RJ 1/16 -CP
SOC-P.W.Board			R4602	06S15615Y55	RES,RK 182J 1/16 -CP
SOC-P.W.Board			R4604	06S15615Y55	RES,RK 182J 1/16 -CP
SOC-P.W.Board			R4607	06-38173Z49	RES,RK 101J 1/4 -CP
SOC-P.W.Board			R4608	06S15615Y73	RES,RK 103J 1/16 -CP
SOC-P.W.Board			R4800	06-38193Z73	RES,RK 102F 1/4 -CP
SOC-P.W.Board			R4801	06S15615Y63	RES,RK 392J 1/16 -CP
SOC-P.W.Board			R4803	06S15615Y63	RES,RK 392J 1/16 -CP
SOC-P.W.Board			R4804	06-38193Z73	RES,RK 102F 1/4 -CP
SOC-P.W.Board			R4805	06-38193Z73	RES,RK 102F 1/4 -CP
SOC-P.W.Board			R4806	06-38193Z73	RES,RK 102F 1/4 -CP
SOC-P.W.Board			R4807	06-38193Z73	RES,RK 102F 1/4 -CP
SOC-P.W.Board			R4808	06S15615Y25	RES,RK 101J 1/16 -CP
SOC-P.W.Board			R4809	06S15615Y81	RES,RK 223J 1/16 -CP
SOC-P.W.Board			R4813	06-38173Z61	RES,RK 331J 1/4 -CP
SOC-P.W.Board			R4814	06-38173Z61	RES,RK 331J 1/4 -CP
SOC-P.W.Board			R4815	06S15615Y27	RES,RK 121J 1/16 -CP
SOC-P.W.Board			R4816	06S15615Y25	RES,RK 101J 1/16 -CP
SOC-P.W.Board			R4817	06S15615Y25	RES,RK 101J 1/16 -CP
SOC-P.W.Board			R4818	06S15615Y25	RES,RK 101J 1/16 -CP
SOC-P.W.Board			R4819	06S15615Y25	RES,RK 101J 1/16 -CP
SOC-P.W.Board			R4820	06S15615Y25	RES,RK 101J 1/16 -CP
SOC-P.W.Board			R4821	06S15615Y25	RES,RK 101J 1/16 -CP
SOC-P.W.Board			R4822	06S15615Y25	RES,RK 101J 1/16 -CP
SOC-P.W.Board			R4823	06S15615Y25	RES,RK 101J 1/16 -CP
SOC-P.W.Board			R4824	06-38193Z40	RES,RK 43RF 1/4 -CP
SOC-P.W.Board			R4825	06-38193Z40	RES,RK 43RF 1/4 -CP
SOC-P.W.Board			R4826	06-38193Z36	RES,RK 30RF 1/4 -CP
SOC-P.W.Board			R4827	06-38193Z36	RES,RK 30RF 1/4 -CP
SOC-P.W.Board			R4828	06-38193Z73	RES,RK 102F 1/4 -CP
SOC-P.W.Board			R4829	06-38193Z73	RES,RK 102F 1/4 -CP
SOC-P.W.Board			R4831	06-38173Z61	RES,RK 331J 1/4 -CP
SOC-P.W.Board			R4832	06-38193Z40	RES,RK 43RF 1/4 -CP
SOC-P.W.Board			R4833	06-38193Z36	RES,RK 30RF 1/4 -CP
SOC-P.W.Board			R4834	06-38193Z73	RES,RK 102F 1/4 -CP
SOC-P.W.Board			R4836	06-38173Z61	RES,RK 331J 1/4 -CP
SOC-P.W.Board			R4837	06-38193Z40	RES,RK 43RF 1/4 -CP
SOC-P.W.Board			R4838	06-38193Z36	RES,RK 30RF 1/4 -CP
SOC-P.W.Board			R5000	06S15615Y25	RES,RK 101J 1/16 -CP
SOC-P.W.Board			R5002	06S15615Y73	RES,RK 103J 1/16 -CP
SOC-P.W.Board			R5003	06-31819Z12	RES,RK R051F 1/3 -CP
SOC-P.W.Board			R5004	06-31819Z12	RES,RK R051F 1/3 -CP
SOC-P.W.Board			R5005	06S15615Y49	RES,RK 102J 1/16 -CP
SOC-P.W.Board			R5008	06S15615Y97	RES,RK 104J 1/16 -CP
SOC-P.W.Board			R5009	06S65415Y35	RES,RK 682F 1/16 -CP
SOC-P.W.Board			R5011	06S15615Y57	RES,RK 222J 1/16 -CP
SOC-P.W.Board			R5012	06S15615Y49	RES,RK 102J 1/16 -CP
SOC-P.W.Board			R5014	06-38173Z59	RES,RK 271J 1/4 -CP
SOC-P.W.Board			R5016	06S15615Y57	RES,RK 222J 1/16 -CP
SOC-P.W.Board			R5017	06S15615Y57	RES,RK 222J 1/16 -CP
SOC-P.W.Board			R5209	06S15615Y05	RES,RK 15RJ 1/16 -CP
SOC-P.W.Board			R5211	06-02713Z14	RES,RK 682D 1/16 -CP
SOC-P.W.Board			R5212	06-02713Z19	RES,RK 183D 1/16 -CP
SOC-P.W.Board			R5213	06-02713Z10	RES,RK 332D 1/16 -CP
SOC-P.W.Board			R5215	06S65415Y93	RES,RK 162F 1/16 -CP
SOC-P.W.Board			R5218	06S15593Y36	RES,RK 301F 1/10 -CP
SOC-P.W.Board			R5219	06S15615Y05	RES,RK 15RJ 1/16 -CP
SOC-P.W.Board			R5221	06S65415Y30	RES,RK 272F 1/16 -CP
SOC-P.W.Board			R5222	06S65415Y38	RES,RK 123F 1/16 -CP
SOC-P.W.Board			R5223	06S65415Y29	RES,RK 222F 1/16 -CP
SOC-P.W.Board			R5224	06-25919Z21	RES,RK 364F 1/16 -CP
SOC-P.W.Board			R5227	06S65415Y46	RES,RK 563F 1/16 -CP
SOC-P.W.Board			R5233	06S15615Y73	RES,RK 103J 1/16 -CP
SOC-P.W.Board			R5400	06S65415Y42	RES,RK 273F 1/16 -CP
SOC-P.W.Board			R5402	06S65415Y47	RES,RK 683F 1/16 -CP
SOC-P.W.Board			R5403	06S65415Y57	RES,RK 474F 1/16 -CP
SOC-P.W.Board			R5405	06-02713Z04	RES,RK 102D 1/16 -CP
SOC-P.W.Board			R5406	06-25919Z06	RES,RK 203F 1/16 -CP
SOC-P.W.Board			R5407	06S65415Y32	RES,RK 392F 1/16 -CP
SOC-P.W.Board			R5409	06S65415Y39	RES,RK 153F 1/16 -CP
SOC-P.W.Board			R5410	06S65415Y25	RES,RK 102F 1/16 -CP
SOC-P.W.Board			R5411	06-38193Z97	RES,RK 103F 1/4 -CP
SOC-P.W.Board			R5415	06S65415Y41	RES,RK 223F 1/16 -CP
SOC-P.W.Board			R5416	06S65415Y47	RES,RK 683F 1/16 -CP
SOC-P.W.Board			R5417	06S65415Y26	RES,RK 122F 1/16 -CP
SOC-P.W.Board			R5418	06S65415Y28	RES,RK 182F 1/16 -CP
SOC-P.W.Board			R5421	06-02713Z19	RES,RK 183D 1/16 -CP
SOC-P.W.Board			R5422	06-02713Z18	RES,RK 153D 1/16 -CP
SOC-P.W.Board			R5424	06-38193Z49	RES,RK 101F 1/4 -CP

P.W.Board	MIS	MODEL	Ref.	Parts No.	Parts Name
SOC-P.W.Board			R5426	06-38193Z49	RES,RK 101F 1/4 -CP
SOC-P.W.Board			R5428	06S65415Y24	RES,RK 821F 1/16 -CP
SOC-P.W.Board			R5429	06S65415Y36	RES,RK 822F 1/16 -CP
SOC-P.W.Board			R5430	06-25919Z09	RES,RK 363F 1/16 -CP
SOC-P.W.Board			R5431	06S65415Y30	RES,RK 272F 1/16 -CP
SOC-P.W.Board			R5435	06S15615Y49	RES,RK 102J 1/16 -CP
SOC-P.W.Board			R5438	06S65415Y34	RES,RK 562F 1/16 -CP
SOC-P.W.Board			R5439	06S65415Y39	RES,RK 153F 1/16 -CP
SOC-P.W.Board			R5440	06S65415Y45	RES,RK 473F 1/16 -CP
SOC-P.W.Board			R5444	06S65415Y61	RES,RK 105F 1/16 -CP
SOC-P.W.Board			R5446	06-38193Z68	RES,RK 621F 1/4 -CP
SOC-P.W.Board			R5460	06S45675W43	RES,RK JUMPER1/10-CP
SOC-P.W.Board			R5600	06S15616Y23	RES,RK JUMPER1/16-CP
SOC-P.W.Board			R5601	06S15616Y23	RES,RK JUMPER1/16-CP
SOC-P.W.Board			R5602	06S15616Y23	RES,RK JUMPER1/16-CP
SOC-P.W.Board			R5603	06S15616Y23	RES,RK JUMPER1/16-CP
SOC-P.W.Board			R5604	06S15616Y23	RES,RK JUMPER1/16-CP
SOC-P.W.Board			R5605	06S15616Y23	RES,RK JUMPER1/16-CP
SOC-P.W.Board			R5606	06S15616Y23	RES,RK JUMPER1/16-CP
SOC-P.W.Board			R5607	06S15616Y23	RES,RK JUMPER1/16-CP
SOC-P.W.Board			R5608	06S15616Y23	RES,RK JUMPER1/16-CP
SOC-P.W.Board			R5609	06S15616Y23	RES,RK JUMPER1/16-CP
SOC-P.W.Board			R5618	06S45675W43	RES,RK JUMPER1/10-CP
SOC-P.W.Board			R5642	06S15615Y53	RES,RK 152J 1/16 -CP
SOC-P.W.Board			R5643	06S15615Y53	RES,RK 152J 1/16 -CP
SOC-P.W.Board			R5647	06S45674W33	RES,RK 101J 1/10 -CP
SOC-P.W.Board			R5648	06S45674W33	RES,RK 101J 1/10 -CP
SOC-P.W.Board			R5649	06S45674W33	RES,RK 101J 1/10 -CP
SOC-P.W.Board			R5650	06S45674W33	RES,RK 101J 1/10 -CP
SOC-P.W.Board			R5651	06S45674W33	RES,RK 101J 1/10 -CP
SOC-P.W.Board			R5652	06S45674W33	RES,RK 101J 1/10 -CP
SOC-P.W.Board			R5653	06S45674W33	RES,RK 101J 1/10 -CP
SOC-P.W.Board			R5654	06S45674W33	RES,RK 101J 1/10 -CP
SOC-P.W.Board			R5655	06S45674W33	RES,RK 101J 1/10 -CP
SOC-P.W.Board			R5656	06S45674W33	RES,RK 101J 1/10 -CP
SOC-P.W.Board			R5657	06S45674W33	RES,RK 101J 1/10 -CP
SOC-P.W.Board			R5902	06S15615Y73	RES,RK 103J 1/16 -CP
SOC-P.W.Board			R5903	06S15615Y25	RES,RK 101J 1/16 -CP
SOC-P.W.Board			R5904	06S15615Y25	RES,RK 101J 1/16 -CP
SOC-P.W.Board			R6000	06S15615Y81	RES,RK 223J 1/16 -CP
SOC-P.W.Board			R6001	06-38193Z80	RES,RK 202F 1/4 -CP
SOC-P.W.Board			R6002	06S15616Y23	RES,RK JUMPER1/16-CP
SOC-P.W.Board			R6003	06S15616Y23	RES,RK JUMPER1/16-CP
SOC-P.W.Board			R6004	06-38173Z73	RES,RK 102J 1/4 -CP
SOC-P.W.Board			R6005	06-38193Z49	RES,RK 101F 1/4 -CP
SOC-P.W.Board			R6007	06-38193Z49	RES,RK 101F 1/4 -CP
SOC-P.W.Board			R6008	06-38173Z73	RES,RK 102J 1/4 -CP
SOC-P.W.Board			R6009	06S15615Y81	RES,RK 223J 1/16 -CP
SOC-P.W.Board			R6010	06S15616Y23	RES,RK JUMPER1/16-CP
SOC-P.W.Board			R6012	06-38173Z49	RES,RK 101J 1/4 -CP
SOC-P.W.Board			R6013	06S15615Y25	RES,RK 101J 1/16 -CP
SOC-P.W.Board			R6014	06S15615Y25	RES,RK 101J 1/16 -CP
SOC-P.W.Board			R6015	06S65415Y33	RES,RK 472F 1/16 -CP
SOC-P.W.Board			R6016	06S65415Y33	RES,RK 472F 1/16 -CP
SOC-P.W.Board			R6017	06S65415Y37	RES,RK 103F 1/16 -CP
SOC-P.W.Board			R6018	06S45674W93	RES,RK 333J 1/10 -CP
SOC-P.W.Board			R6019	06S45674W93	RES,RK 333J 1/10 -CP
SOC-P.W.Board			R6020	06S65415Y37	RES,RK 103F 1/16 -CP
SOC-P.W.Board			R6028	06-38173Z49	RES,RK 101J 1/4 -CP
SOC-P.W.Board			R6029	06-38193Z97	RES,RK 103F 1/4 -CP
SOC-P.W.Board			R6030	06S65415Y49	RES,RK 104F 1/16 -CP
SOC-P.W.Board			R6031	06S65415Y37	RES,RK 103F 1/16 -CP
SOC-P.W.Board			R6032	06S65415Y37	RES,RK 103F 1/16 -CP
SOC-P.W.Board			R6033	06S65415Y37	RES,RK 103F 1/16 -CP
SOC-P.W.Board			R6034	06S65415Y37	RES,RK 103F 1/16 -CP
SOC-P.W.Board			R6035	06-38174Z14	RES,RK 473J 1/4 -CP
SOC-P.W.Board			R6036	06-25919Z05	RES,RK 163F 1/16 -CP
SOC-P.W.Board			R6037	06-25919Z07	RES,RK 243F 1/16 -CP
SOC-P.W.Board			R6038	06-38193Z80	RES,RK 202F 1/4 -CP
SOC-P.W.Board			R6040	06S15616Y23	RES,RK JUMPER1/16-CP
SOC-P.W.Board			R6043	06S65415Y45	RES,RK 473F 1/16 -CP
SOC-P.W.Board			SD5400	48-32691Z01	DIO,SHT RBR3MM60A-CP
SOC-P.W.Board			SD5600	48-32691Z01	DIO,SHT RBR3MM60A-CP
SOC-P.W.Board			SF4000	91-39634Z01	SAW,B39162B3913U4-E1
SOC-P.W.Board			TML5900	29-25576Z01	IPS-16105T-01Y900-E5
SOC-P.W.Board			TML5903	29-40504Z01	OGC-224018U -E1
SOC-P.W.Board			TML5904	29-40504Z01	OGC-224018U -E1
SOC-P.W.Board			TU4000	TU-42611Z02	NEO-M8L-06B -EJ
SOC-P.W.Board			XL3400	91-26661Z03	XTL,NX3225SAAG24.0CP
SOC-P.W.Board			XL4400	91-26661Z32	XTL,NX3225SAAG28.6CP
SOC-P.W.Board			ZD4401	48-34057Z01	DIO,ZEN TPD2E2U06-CP
SOC-P.W.Board			ZD4402	48-29509Z09	DIO,ZEN UDZVFH5.1BCP
SOC-P.W.Board			ZD4403	48-28494Z01	DIO,ZEN ECMF04-4H-CP
SOC-P.W.Board			ZD4404	48-28494Z01	DIO,ZEN ECMF04-4H-CP
SOC-P.W.Board			ZD4600	48-28494Z01	DIO,ZEN ECMF04-4H-CP
SOC-P.W.Board			ZD4601	48-28494Z01	DIO,ZEN ECMF04-4H-CP
SOC-P.W.Board			ZD5600	48-28494Z01	DIO,ZEN ECMF04-4H-CP
SOC-P.W.Board			ZD5601	48-28494Z01	DIO,ZEN ECMF04-4H-CP

P.W.Board	MIS	MODEL	Ref.	Parts No.	Parts Name
SOC-P.W.Board			ZD5602	48-28494Z01	DIO,ZEN ECMF04-4H-CP
DISP-7 RC1-P.W.Board			C7004	08-32871Z07	CAP,CER103KX7R1CQ2CP
DISP-7 RC1-P.W.Board			C7005	08-32871Z07	CAP,CER103KX7R1CQ2CP
DISP-7 RC1-P.W.Board			C7100	08-38004Z05	CAP,CER 106KX5R1H-CP
DISP-7 RC1-P.W.Board			C7103	08-38004Z05	CAP,CER 106KX5R1H-CP
DISP-7 RC1-P.W.Board			C7105	08-32877Z11	CAP,CER 224MX7R1H-CP
DISP-7 RC1-P.W.Board			C7106	08-37800Z10	CAP,CER 474KX5R1A-CP
DISP-7 RC1-P.W.Board			C7107	08-32861Z07	CAP,CER 225KX7R1H-CP
DISP-7 RC1-P.W.Board			C7108	08-32871Z07	CAP,CER103KX7R1CQ2CP
DISP-7 RC1-P.W.Board			C7109	08-34782Z13	CAP,CER 105KX5R1H-CP
DISP-7 RC1-P.W.Board			C7110	08-38014Z03	CAP,CER 475KX5R0J-CP
DISP-7 RC1-P.W.Board			C7111	08-37800Z15	CAP,CER 102KX5R1H-CP
DISP-7 RC1-P.W.Board			C7115	08-37800Z16	CAP,CER 222KX5R1H-CP
DISP-7 RC1-P.W.Board			C7116	08-38004Z05	CAP,CER 106KX5R1H-CP
DISP-7 RC1-P.W.Board			C7117	08-37800Z16	CAP,CER 222KX5R1H-CP
DISP-7 RC1-P.W.Board			C7118	08-32861Z07	CAP,CER 225KX7R1H-CP
DISP-7 RC1-P.W.Board			C7119	08-32877Z11	CAP,CER 224MX7R1H-CP
DISP-7 RC1-P.W.Board			C7120	08-32861Z07	CAP,CER 225KX7R1H-CP
DISP-7 RC1-P.W.Board			C7200	08-37972Z07	CAP,CER 106KX7R1H-CP
DISP-7 RC1-P.W.Board			C7201	08-37972Z07	CAP,CER 106KX7R1H-CP
DISP-7 RC1-P.W.Board			C7202	08-32878Z03	CAP,CER104KX7R1HQ2CP
DISP-7 RC1-P.W.Board			C7203	08-34782Z06	CAP,CER 106KX5R1A-CP
DISP-7 RC1-P.W.Board			C7206	08-33201Z06	CAP,CER 226MX5R1C-CP
DISP-7 RC1-P.W.Board			C7209	08-32877Z11	CAP,CER 224MX7R1H-CP
DISP-7 RC1-P.W.Board			C7210	08-32877Z11	CAP,CER 224MX7R1H-CP
DISP-7 RC1-P.W.Board			C7300	08-33201Z01	CAP,CER226KX5R1AQ3CP
DISP-7 RC1-P.W.Board			C7500	08-37800Z07	CAP,CER 105KX5R0J-CP
DISP-7 RC1-P.W.Board			C7501	08-38014Z03	CAP,CER 475KX5R0J-CP
DISP-7 RC1-P.W.Board			C7502	08-37793Z24	CAP,CER 104KX5R1A-CP
DISP-7 RC1-P.W.Board			C7503	08-37793Z24	CAP,CER 104KX5R1A-CP
DISP-7 RC1-P.W.Board			C7504	08-37800Z07	CAP,CER 105KX5R0J-CP
DISP-7 RC1-P.W.Board			C7506	08-37793Z24	CAP,CER 104KX5R1A-CP
DISP-7 RC1-P.W.Board			C7507	08-37793Z29	CAP,CER 103KX5R1C-CP
DISP-7 RC1-P.W.Board			C7508	08-37793Z24	CAP,CER 104KX5R1A-CP
DISP-7 RC1-P.W.Board			C7510	08-37800Z07	CAP,CER 105KX5R0J-CP
DISP-7 RC1-P.W.Board			C7600	08-37972Z07	CAP,CER 106KX7R1H-CP
DISP-7 RC1-P.W.Board			C7601	08-32877Z11	CAP,CER 224MX7R1H-CP
DISP-7 RC1-P.W.Board			C7602	08-33201Z05	CAP,CER 106KX5R1C-CP
DISP-7 RC1-P.W.Board			C7603	08-32877Z11	CAP,CER 224MX7R1H-CP
DISP-7 RC1-P.W.Board			CB7000	09-38313Z03	FFC,FH52K-50S-0.5-EQ
DISP-7 RC1-P.W.Board			CB7100	09-38572Z02	FFC,IMSA12001S10Y-E9
DISP-7 RC1-P.W.Board			CB7300	09-38572Z04	FFC,IMSA12001S30Y-EQ
DISP-7 RC1-P.W.Board			CB7501	09-28657Z05	FFC,IMSA9685S-50Y-EZ
DISP-7 RC1-P.W.Board			CB8100	09-38572Z04	FFC,IMSA12001S30Y-EQ
DISP-7 RC1-P.W.Board			IC7100	51-25969Z02	MAX16813BATP/V+ -LE2
DISP-7 RC1-P.W.Board			IC7200	51-36700Z01	RTQ2104BGSP-QA -SE2
DISP-7 RC1-P.W.Board			IC7500	51-38306Z01	CYAT81682-100AA61-QT
DISP-7 RC1-P.W.Board			IC7500	83-44774Z16	21GDA 7UNI TP IC7500
DISP-7 RC1-P.W.Board			IC7600	51-28614Z01	BD00FC0EEFJ-ME2 -SE2
DISP-7 RC1-P.W.Board			L7100	24-38454Z11	IND,AWVS80804047RME6
DISP-7 RC1-P.W.Board			L7101	24-40402Z03	FBI,BLM18PG331SZ1-CP
DISP-7 RC1-P.W.Board			L7201	24-31696Z06	IND,DFE252012P4R7MCP
DISP-7 RC1-P.W.Board			L7300	24-40402Z05	FBI,BLM18KG221SZ1-CP
DISP-7 RC1-P.W.Board			L7500	24-40402Z03	FBI,BLM18PG331SZ1-CP
DISP-7 RC1-P.W.Board			Q7100	48-37066Z03	TR,RN1107MFV -CP
DISP-7 RC1-P.W.Board			Q7101	48-41596Z01	FET,SSM6K809R -CP
DISP-7 RC1-P.W.Board			Q8000	48-37059Z01	TR,2SC4116-GR -CP
DISP-7 RC1-P.W.Board			Q8001	48-37066Z02	TR,RN1105MFV -CP
DISP-7 RC1-P.W.Board			R7001	06S15615Y25	RES,RK 101J 1/16 -CP
DISP-7 RC1-P.W.Board			R7002	06S15615Y25	RES,RK 101J 1/16 -CP
DISP-7 RC1-P.W.Board			R7003	06S15615Y25	RES,RK 101J 1/16 -CP
DISP-7 RC1-P.W.Board			R7004	06S15615Y25	RES,RK 101J 1/16 -CP
DISP-7 RC1-P.W.Board			R7005	06S15615Y25	RES,RK 101J 1/16 -CP
DISP-7 RC1-P.W.Board			R7006	06S15615Y25	RES,RK 101J 1/16 -CP
DISP-7 RC1-P.W.Board			R7100	06S15615Y49	RES,RK 102J 1/16 -CP
DISP-7 RC1-P.W.Board			R7101	06S15615Y57	RES,RK 222J 1/16 -CP
DISP-7 RC1-P.W.Board			R7102	06S65415Y43	RES,RK 333F 1/16 -CP
DISP-7 RC1-P.W.Board			R7103	06S65415Y37	RES,RK 103F 1/16 -CP
DISP-7 RC1-P.W.Board			R7104	06S65415Y25	RES,RK 102F 1/16 -CP
DISP-7 RC1-P.W.Board			R7105	06S65415Y13	RES,RK 101F 1/16 -CP
DISP-7 RC1-P.W.Board			R7106	06S65415Y37	RES,RK 103F 1/16 -CP
DISP-7 RC1-P.W.Board			R7109	06S65415Y55	RES,RK 334F 1/16 -CP
DISP-7 RC1-P.W.Board			R7110	06S65415Y39	RES,RK 153F 1/16 -CP
DISP-7 RC1-P.W.Board			R7112	06S65415Y41	RES,RK 223F 1/16 -CP
DISP-7 RC1-P.W.Board			R7113	06S65415Y25	RES,RK 102F 1/16 -CP
DISP-7 RC1-P.W.Board			R7114	06S15615Y01	RES,RK 10RJ 1/16 -CP
DISP-7 RC1-P.W.Board			R7115	06S65415Y30	RES,RK 272F 1/16 -CP
DISP-7 RC1-P.W.Board			R7116	06S65415Y40	RES,RK 183F 1/16 -CP
DISP-7 RC1-P.W.Board			R7117	06S65415Y37	RES,RK 103F 1/16 -CP
DISP-7 RC1-P.W.Board			R7118	06-34198Z05	RES,RK R47F 1/4 -CP
DISP-7 RC1-P.W.Board			R7119	06-34198Z05	RES,RK R47F 1/4 -CP
DISP-7 RC1-P.W.Board			R7200	06S15615Y05	RES,RK 15RJ 1/16 -CP
DISP-7 RC1-P.W.Board			R7202	06S65415Y34	RES,RK 562F 1/16 -CP
DISP-7 RC1-P.W.Board			R7203	06S65415Y15	RES,RK 151F 1/16 -CP
DISP-7 RC1-P.W.Board			R7205	06S65415Y40	RES,RK 183F 1/16 -CP
DISP-7 RC1-P.W.Board			R7209	06S15593Y53	RES,RK 152F 1/10 -CP
DISP-7 RC1-P.W.Board			R7500	06S15616Y23	RES,RK JUMPER1/16-CP
DISP-7 RC1-P.W.Board			R7512	06S15615Y49	RES,RK 102J 1/16 -CP

P.W.Board	MIS	MODEL	Ref.	Parts No.	Parts Name
DISP-7 RC1-P.W.Board			R7515	06S15615Y49	RES,RK 102J 1/16 -CP
DISP-7 RC1-P.W.Board			R7517	06S65415Y33	RES,RK 472F 1/16 -CP
DISP-7 RC1-P.W.Board			R7518	06S15616Y24	RES,RK 1R0J 1/16 -CP
DISP-7 RC1-P.W.Board			R7519	06S15616Y24	RES,RK 1R0J 1/16 -CP
DISP-7 RC1-P.W.Board			R7600	06S65415Y48	RES,RK 823F 1/16 -CP
DISP-7 RC1-P.W.Board			R7601	06S65415Y30	RES,RK 272F 1/16 -CP
DISP-7 RC1-P.W.Board			R7602	06S65415Y36	RES,RK 822F 1/16 -CP
DISP-7 RC1-P.W.Board			R7603	06-25919Z15	RES,RK 114F 1/16 -CP
DISP-7 RC1-P.W.Board			R7604	06S65415Y34	RES,RK 562F 1/16 -CP
DISP-7 RC1-P.W.Board			R8001	06S15615Y49	RES,RK 102J 1/16 -CP
DISP-7 RC1-P.W.Board			R8002	06S15615Y89	RES,RK 473J 1/16 -CP
DISP-7 RC1-P.W.Board			R8006	06S65415Y33	RES,RK 472F 1/16 -CP
DISP-7 RC1-P.W.Board			R8007	06S65415Y95	RES,RK 242F 1/16 -CP
DISP-7 RC1-P.W.Board			R8008	06S65415Y33	RES,RK 472F 1/16 -CP
DISP-7 RC1-P.W.Board			R8009	06S65415Y32	RES,RK 392F 1/16 -CP
DISP-7 RC1-P.W.Board			R8010	06S65415Y33	RES,RK 472F 1/16 -CP
DISP-7 RC1-P.W.Board			R8011	06S65415Y32	RES,RK 392F 1/16 -CP
DISP-7 RC1-P.W.Board			R8014	06S65415Y30	RES,RK 272F 1/16 -CP
DISP-7 RC1-P.W.Board			R8015	06S65415Y32	RES,RK 392F 1/16 -CP
DISP-7 RC1-P.W.Board			R8016	06S65415Y26	RES,RK 122F 1/16 -CP
DISP-7 RC1-P.W.Board			R8017	06S65415Y22	RES,RK 561F 1/16 -CP
DISP-7 RC1-P.W.Board			R8018	06S65415Y33	RES,RK 472F 1/16 -CP
DISP-7 RC1-P.W.Board			R8019	06S65415Y33	RES,RK 472F 1/16 -CP
DISP-7 RC1-P.W.Board			R8020	06S65415Y26	RES,RK 122F 1/16 -CP
DISP-7 RC1-P.W.Board			R8021	06S65415Y22	RES,RK 561F 1/16 -CP
DISP-7 RC1-P.W.Board			R8022	06S65415Y30	RES,RK 272F 1/16 -CP
DISP-7 RC1-P.W.Board			R8023	06S65415Y32	RES,RK 392F 1/16 -CP
DISP-7 RC1-P.W.Board			R8026	06S65415Y33	RES,RK 472F 1/16 -CP
DISP-7 RC1-P.W.Board			R8027	06S65415Y32	RES,RK 392F 1/16 -CP
DISP-7 RC1-P.W.Board			R8028	06S65415Y33	RES,RK 472F 1/16 -CP
DISP-7 RC1-P.W.Board			R8029	06S65415Y32	RES,RK 392F 1/16 -CP
DISP-7 RC1-P.W.Board			R8030	06S65415Y33	RES,RK 472F 1/16 -CP
DISP-7 RC1-P.W.Board			R8031	06S65415Y32	RES,RK 392F 1/16 -CP
DISP-7 RC1-P.W.Board			SD7100	48-32691Z03	DIO,SHT RBR3MM60A-CP
DISP-7 RC1-P.W.Board			TML7400	29-25576Z01	IPS-16105T-01Y900-E5
DISP-7 RC1-P.W.Board			TML7401	29-25576Z01	IPS-16105T-01Y900-E5
DISP-7 RC1-P.W.Board			TML7403	29-25576Z01	IPS-16105T-01Y900-E5
DISP-7 RC1-P.W.Board			TML7408	29-25576Z01	IPS-16105T-01Y900-E5
DISP-7 RC1-P.W.Board			TML7409	29-35151Z01	IPS-4080T-01Y900 -EA
DISP-7 RC1-P.W.Board			TML7410	29-35151Z01	IPS-4080T-01Y900 -EA
KEY-7 RC1-P.W.Board			C8300	08-32871Z19	CAP,CER 104KX7R1A-CP
KEY-7 RC1-P.W.Board			C8301	08-38014Z03	CAP,CER 475KX5R0J-CP
KEY-7 RC1-P.W.Board			C8302	08-32878Z04	CAP,CER225KX7R0JQ2CP
KEY-7 RC1-P.W.Board			CB8300	09-25711Z01	FFC,FH33-30S-0.5SHE7
KEY-7 RC1-P.W.Board			D8300	48-35785Z01	DIO,ZEN DF2B6.8M1-CP
KEY-7 RC1-P.W.Board			D8301	48-35785Z01	DIO,ZEN DF2B6.8M1-CP
KEY-7 RC1-P.W.Board			D8302	48-35785Z01	DIO,ZEN DF2B6.8M1-CP
KEY-7 RC1-P.W.Board			D8303	48-35785Z01	DIO,ZEN DF2B6.8M1-CP
KEY-7 RC1-P.W.Board			D8304	48-35785Z01	DIO,ZEN DF2B6.8M1-CP
KEY-7 RC1-P.W.Board			D8305	48-35785Z01	DIO,ZEN DF2B6.8M1-CP
KEY-7 RC1-P.W.Board			D8307	48-35785Z01	DIO,ZEN DF2B6.8M1-CP
KEY-7 RC1-P.W.Board			D8308	48-35785Z01	DIO,ZEN DF2B6.8M1-CP
KEY-7 RC1-P.W.Board			D8309	48-35785Z01	DIO,ZEN DF2B6.8M1-CP
KEY-7 RC1-P.W.Board			D8310	48-35785Z01	DIO,ZEN DF2B6.8M1-CP
KEY-7 RC1-P.W.Board			D8311	48-35785Z01	DIO,ZEN DF2B6.8M1-CP
KEY-7 RC1-P.W.Board			D8312	48-35785Z01	DIO,ZEN DF2B6.8M1-CP
KEY-7 RC1-P.W.Board			IC8300	51-43073Z01	IRM-H538M3/TR2 -NE2
KEY-7 RC1-P.W.Board			LD8300	48-38346Z02	LED,WHT VCEW1151C-CP
KEY-7 RC1-P.W.Board			LD8301	48-38346Z02	LED,WHT VCEW1151C-CP
KEY-7 RC1-P.W.Board			LD8302	48-38346Z02	LED,WHT VCEW1151C-CP
KEY-7 RC1-P.W.Board			LD8303	48-38346Z02	LED,WHT VCEW1151C-CP
KEY-7 RC1-P.W.Board			LD8304	48-38346Z02	LED,WHT VCEW1151C-CP
KEY-7 RC1-P.W.Board			LD8305	48-38346Z02	LED,WHT VCEW1151C-CP
KEY-7 RC1-P.W.Board			LD8306	48-38394Z02	LED,BLU NESB146AT-CP
KEY-7 RC1-P.W.Board			LD8307	48-38346Z02	LED,WHT VCEW1151C-CP
KEY-7 RC1-P.W.Board			LD8308	48-38346Z02	LED,WHT VCEW1151C-CP
KEY-7 RC1-P.W.Board			LD8309	48-38346Z02	LED,WHT VCEW1151C-CP
KEY-7 RC1-P.W.Board			LD8310	48-38346Z02	LED,WHT VCEW1151C-CP
KEY-7 RC1-P.W.Board			LD8311	48-38346Z02	LED,WHT VCEW1151C-CP
KEY-7 RC1-P.W.Board			LD8312	48-38346Z02	LED,WHT VCEW1151C-CP
KEY-7 RC1-P.W.Board			PD8300	48-42341Z01	PHT,DIO S11153-01-E2
KEY-7 RC1-P.W.Board			R8300	06S65415Y43	RES,RK 333F 1/16 -CP
KEY-7 RC1-P.W.Board			R8301	06S65415Y29	RES,RK 222F 1/16 -CP
KEY-7 RC1-P.W.Board			R8302	06S65415Y31	RES,RK 332F 1/16 -CP
KEY-7 RC1-P.W.Board			R8303	06S65415Y33	RES,RK 472F 1/16 -CP
KEY-7 RC1-P.W.Board			R8304	06S65415Y37	RES,RK 103F 1/16 -CP
KEY-7 RC1-P.W.Board			R8305	06S65415Y43	RES,RK 333F 1/16 -CP
KEY-7 RC1-P.W.Board			R8306	06S65415Y30	RES,RK 272F 1/16 -CP
KEY-7 RC1-P.W.Board			R8307	06S65415Y32	RES,RK 392F 1/16 -CP
KEY-7 RC1-P.W.Board			R8308	06S65415Y36	RES,RK 822F 1/16 -CP
KEY-7 RC1-P.W.Board			R8309	06S65415Y42	RES,RK 273F 1/16 -CP
KEY-7 RC1-P.W.Board			R8311	06S45674W25	RES,RK 47RJ 1/10 -CP
KEY-7 RC1-P.W.Board			R8312	06S15615Y73	RES,RK 103J 1/16 -CP
KEY-7 RC1-P.W.Board			R8313	06S15615Y49	RES,RK 102J 1/16 -CP
KEY-7 RC1-P.W.Board			SW8300	SKRPACE010	SW,TACT SKRPACE010E2
KEY-7 RC1-P.W.Board			SW8301	SKRPACE010	SW,TACT SKRPACE010E2
KEY-7 RC1-P.W.Board			SW8302	SKRPACE010	SW,TACT SKRPACE010E2
KEY-7 RC1-P.W.Board			SW8303	SKRPACE010	SW,TACT SKRPACE010E2

P.W.Board	MIS	MODEL	Ref.	Parts No.	Parts Name
KEY-7 RC1-P.W.Board			SW8304	SKRSPACE010	SW,TACT SKRSPACE010E2
KEY-7 RC1-P.W.Board			SW8305	SKRSPACE010	SW,TACT SKRSPACE010E2
KEY-7 RC1-P.W.Board			SW8306	SKRSPACE010	SW,TACT SKRSPACE010E2
KEY-7 RC1-P.W.Board			SW8307	SKRSPACE010	SW,TACT SKRSPACE010E2
KEY-7 RC1-P.W.Board			SW8308	SKRSPACE010	SW,TACT SKRSPACE010E2
KEY-7 RC1-P.W.Board			SW8309	SKRSPACE010	SW,TACT SKRSPACE010E2
Miscellaneous(Refer to exploded view data.)			ANT1	09-39981Z01	ASSY,ASAA-1086-39A
Miscellaneous(Refer to exploded view data.)			ANT2	09-19615Z02	ASSY,ANID-0139-02A
Miscellaneous(Refer to exploded view data.)			CH1	09-44184Z01	ASSY,ANID-2082-01A
Miscellaneous(Refer to exploded view data.)			CH2	09-24492Z07	ASSY,U.FL-2LPHF6N2
Miscellaneous(Refer to exploded view data.)			ET1	HCDSF0K019C	ASSY,HCDSF0K019C
Miscellaneous(Refer to exploded view data.)			LCD1	65-38780Z01	ASSY,COG-ALPI7002-02
Miscellaneous(Refer to exploded view data.)			M1	59-33274Z02	MOTOR,LF40A05PAP15A