

Exploded View (Cabinet) (1/2)

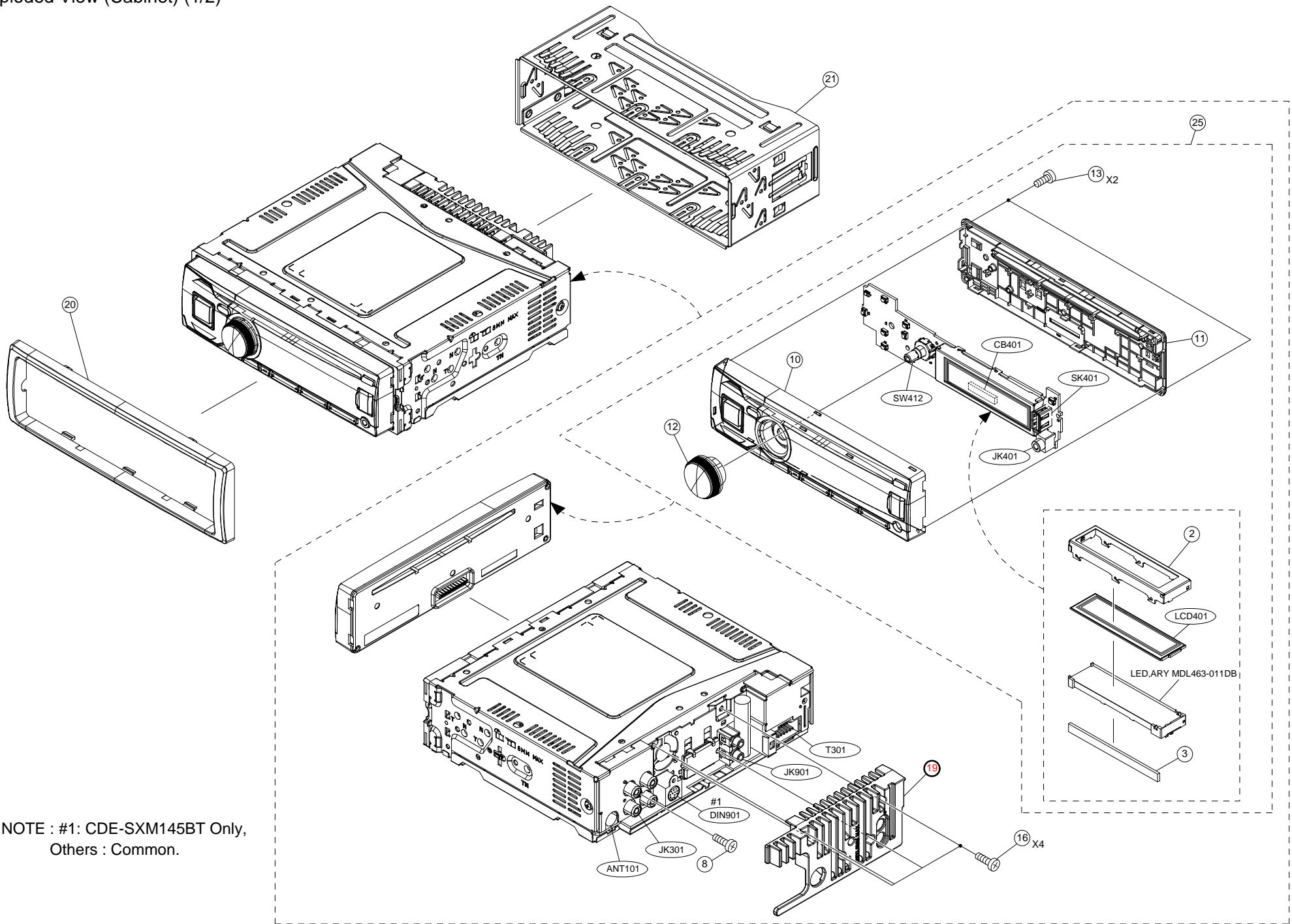

NOTE : #1: CDE-SXM145BT Only,
Others : Common.

MODEL	Symbol No.	Parts No.	Description
	2	15-23773Z01	COVER,LCD
	3	75-24550Z01	RUBBER,GSS
	5	-----	BKT,CHAS REAR
	6	-----	BKT,IC SYS
	7	-----	HEAT,SINK SYS
	8	03S60825Y04	SCR,B-T 3X8 ZN A
	9	03S60822Y22	SCR,S-T 2.6X14 ZN A
#1	10	EN-24338Z20	NOSE,PIECE ASSY
#2	10	EN-24338Z07	NOSE,PIECE ASSY
\$1	10	EN-24338Z09	NOSE,PIECE ASSY
\$2	10	EN-24338Z09	NOSE,PIECE ASSY
%1	10	EN-24338Z21	NOSE,PIECE ASSY
&1	10	EN-24338Z10	NOSE,PIECE ASSY
	11	13-23791Z01	NOSE,BOTTOM
#1	12	36-24673Z01	KNOB,ROTARY ASSY
#2	12	36-23793Z01	KNOB,ROTARY ASSY
\$1	12	36-23793Z01	KNOB,ROTARY ASSY
\$2	12	36-23793Z01	KNOB,ROTARY ASSY
%1	12	36-23793Z01	KNOB,ROTARY ASSY
&1	12	36-23793Z01	KNOB,ROTARY ASSY
	13	03-02876Z28	SCR,WEV 1.7X7 ZB A
	14	EN-24496Z02	NOSE,BASE ASSY
	15	03S60822Y13	SCR,S-T 2.6X6 ZN A
	16	03S60822Y22	SCR,S-T 2.6X14 ZN A
	17	-----	CHAS,BASE
	18	-----	COVER,BOTTOM
	19	-----	HEAT,SINK PWR
	20	33-23980Z01	FACE,PLATE
	21	15-24381Z01	CASE,INNER
	22	30-19721Z08	SML2CD-24X107-BDX6
	23	DP-23767Z01	DP86Z7BA
#1	25	SU-25392Z01	SERVICE_NOSE
#2	25	SU-25391Z01	SERVICE_NOSE
\$1	25	SU-25395Z01	SERVICE_NOSE
\$2	25	SU-25395Z01	SERVICE_NOSE
%1	25	SU-25396Z01	SERVICE_NOSE
&1	25	SU-25397Z01	SERVICE_NOSE
	ANT101	09T25015Y01	ANT,RECEPTACLE -DB

Mark Model Code
CDE-SXM145BT Only,

#1

#2 CDE-143BT Only,

\$1 CDE-143EBT Only,

\$2 CDE-143EBT(Arabia language) Only,

%1 CDE-143EBTTH Only,

&1 CDE-143CBT Only,

Others:Common.

NOTE:The part that has not PART NUMBER will not be supplied.

MODEL	Symbol No.	Parts No.	Description
	CB401	09-18716Z01	BTB,DF20-P -EJ
	CH501	09-18738Z01	BTB,DF20-S -DB
#1	DIN901	09-18874Z01	DIN,TCS7718-012117DB
	JK301	09-25329Z01	RCA,RJ-1346C41-0H0DB
	JK401	09-18872Z01	JAC,1850383000322-DB
#1	JK901	09-14149Z01	JAC,CK3-3.5-14D -DB
#2	JK901	09-14149Z01	JAC,CK3-3.5-14D -DB
\$1	JK901	09T03156K01	JAC,CK-3.5-14 -DB
\$2	JK901	09T03156K01	JAC,CK-3.5-14 -DB
%1	JK901	09T03156K01	JAC,CK-3.5-14 -DB
&1	JK901	09T03156K01	JAC,CK-3.5-14 -DB
#1	LCD401	65-23891Z02	LCD,EH0562M0TTNJ-FZ
#2	LCD401	65-23891Z01	LCD,EH0052M0TTNJ-FZ
\$1	LCD401	65-23891Z01	LCD,EH0052M0TTNJ-FZ
\$2	LCD401	65-23891Z01	LCD,EH0052M0TTNJ-FZ
%1	LCD401	65-23891Z01	LCD,EH0052M0TTNJ-FZ
&1	LCD401	65-23891Z01	LCD,EH0052M0TTNJ-FZ
	SK401	09-19382Z01	SKT,CM-V105 -DB
	SW412	40-10735Z02	ENC,EC12D1524405 -DB
	SW501	40T16096W03	SW ,TACT SKHHLW
	T301	25-25218Z01	ASSY,A039A0001 -DB

Mark Model Code
CDE-SXM145BT Only,

#1

#2 CDE-143BT Only,

\$1 CDE-143EBT Only,

\$2 CDE-143EBT(Arabia language) Only,

%1 CDE-143EBTTH Only,

&1 CDE-143CBT Only,

Others:Common.

NOTE:The part that has not PART NUMBER will not be supplied.

Exploded View (CD Deck Mechanism)

(DP86Z7BA)

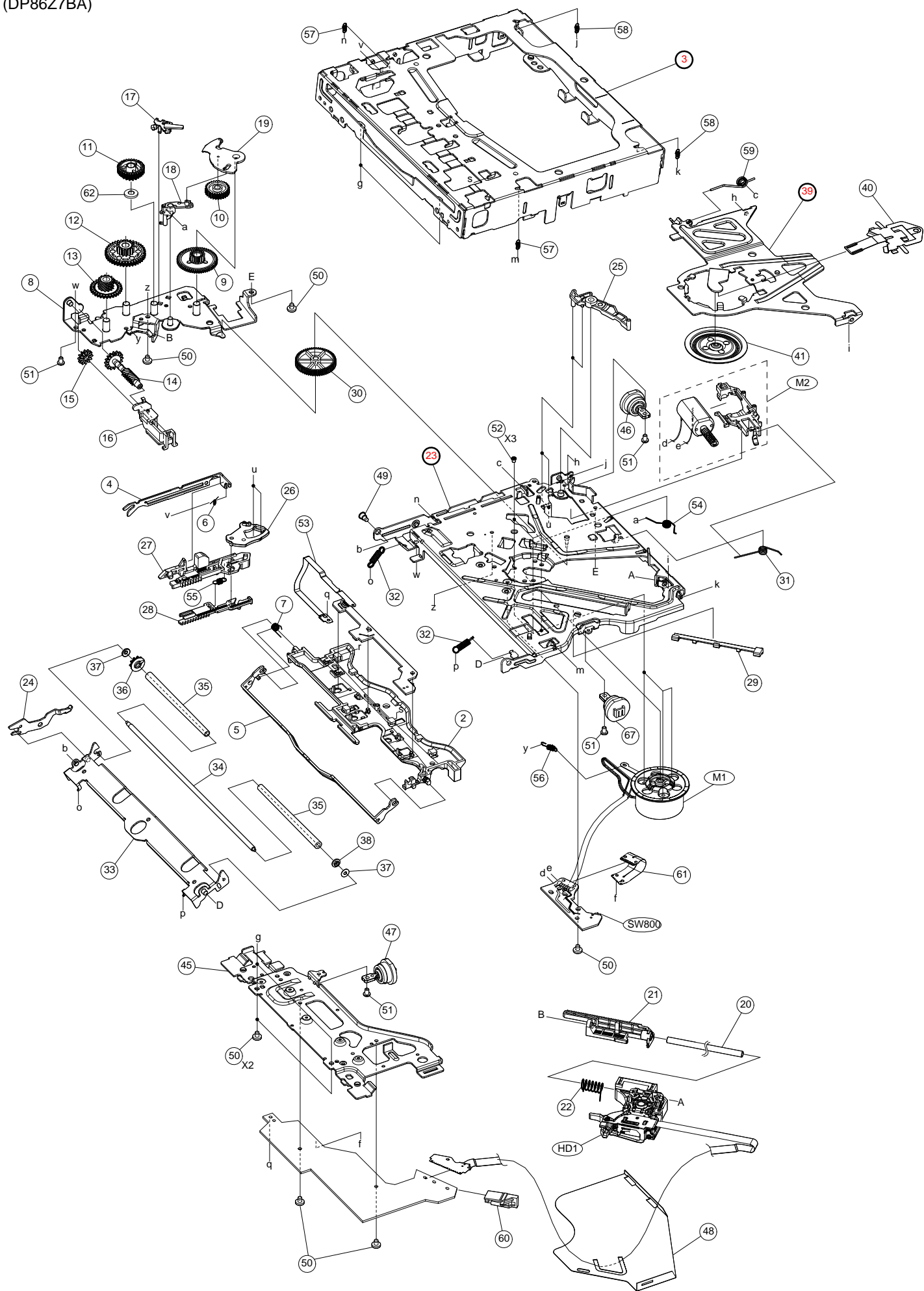

MODEL	Symbol No.	Parts No.	Description
	2	15-18550Z02	GUIDE,TOP DP-R
	3	-----	CHAS,TOP DP-R 4
	4	45-18546Z02	SLIDER,SHUTTER DP-R
	5	45-21916Z02	ARM,SHUTTER DP-R 2
	6	41-25310Z01	SPRING,TOR SLD SHUT
	7	41-19038Z03	SPRING,TOR SHUTTER
	8	07-18543Z02	BKT,GEAR DP-R
	9	44-18560Z02	GEAR,2 DP-R
	10	44-18561Z02	GEAR,3 DP-R
	11	44-18562Z02	GEAR,4 DP-R
	12	44-18563Z02	GEAR,5 DP-R
	13	44-18564Z02	GEAR,6 DP-R
	14	44-22407Z02	GEAR,7 DP-R 2
	15	44-22408Z02	GEAR,8 DP-R 2
	16	07-22406Z02	BKT,ROLLER GEAR 2
	17	07-18556Z02	BKT,IDLER DP-R
	18	45-18568Z02	LEVER,PICK DP-R
	19	45-18569Z02	LEVER,GEAR DP-R
	20	47-19048Z01	SHAFT,PICK DP-R
	21	44-18574Z02	RACK,SLED DP-R
	22	41-19044Z02	SPRING,SLED DP-R
	23	-----	ASSY,RIV CHAS DRIVE
	24	45-18548Z02	LEVER,ROLLER DP-R
	25	45-18570Z02	LEVER,TRIGGER DP-R
	26	45-18571Z02	LEVER,LOCK DP-R
	27	45-18572Z02	SLIDER,LOAD DP-R
	28	45-18573Z02	SLIDER,TRIGGER DP-R
	29	15-18576Z02	GUIDE,PICK SUB DP-R
	30	44-18559Z02	GEAR,1 DP-R
	31	41-19040Z02	SPRING,TOR WORM
	32	41-19046Z01	SPRING,COIL ROLLER

Mark Model Code

- #1 CDE-141 Only,
- #2 CDE-171R Only,
- #3 CDE-171RR Only,
- #4 CDE-171RM Only,
- #5 CDE-142E Only,
- \$1 CDE-141E Only,
- \$2 CDE-141E(Arabia language) Only,
- \$3 CDE-141ETH Only,
- \$4 CDE-141C Only,
- %1 CDE-140 Only,
- %2 CDE-170R Only,
- %3 CDE-170RR Only,
- %4 CDE-170RM Only,
- &1 CDE-140E Only,
- &2 CDE-140E(Arabia language) Only,
- &3 CDE-140ETH Only,
- &4 CDE-140C Only,

Others:Common.

NOTE:The part that has not PART NUMBER will not be supplied.

MODEL	Symbol No.	Parts No.	Description
	33	45-22132Z02	ARM,DISC GUIDE 2
	34	47-19049Z01	SHAFT,ROLLER DP-R
	35	49-06683Z03	ROLLER,DV43M
	36	44-18567Z02	GEAR,ROLLER DP-R
	37	43-18554Z02	BUSH,ROLLER DP-R
	38	04S40075G88	WAS,LOC 1.7X4.5X0.25
	39	-----	ARM,CLAMP DP-R
	40	41-18549Z02	SPRING,CLAMPER DP-R
	41	43-18552Z02	TABLE,CLAMPER DP-R
	45	07-18542Z02	BKT,DAMPER DP-R
	46	75-20957Z04	DAMPER,DP-Z 2
	47	75-20957Z02	DAMPER,DP-Z 2
	48	14-22756Z01	INSULATOR,FPC DP-Z
	49	03-22573Z01	SCR,ARM GUIDE 2 DP-Z
	50	03S60822Y96	SCR,S-T 2X2.5 ZN A
	51	03-00340Z32	SCR,S-T 2X3.5 ZB A
	52	03-01599Z10	SCR,MCH 1.7X1.8 NN
	53	84-19730Z01	FPC,LED DP-Z
	54	41-19043Z01	SPRING,TOR LEV PICK
	55	41-19041Z01	SPRING,COIL TRIGGER
	56	41-20950Z01	SPRING,COIL SPINDLE
	57	41-24156Z01	SPRING,COIL DRIVE-F
	58	41-24156Z02	SPRING,COIL DRIVE-R
	59	41-19042Z02	SPRING,TOR CLAMP
	60	07-23319Z02	BKT,FPC PICK DP-Z
	61	84-21702Z01	FPC,DRIVE 8BF DP-Z
	62	04S40075G96	WAS,LOC 4.1X7.0X0.13
	67	75-20957Z01	DAMPER,DP-Z 2
	HD1	EP-17785Z01	EP21A99N
	M1	66-23978Z27	ASSY,MTR SPDL RF300
	M2	66-23978Z28	ASSY,MTR SLED 2

Mark Model Code

- #1 CDE-141 Only,
- #2 CDE-171R Only,
- #3 CDE-171RR Only,
- #4 CDE-171RM Only,
- #5 CDE-142E Only,
- \$1 CDE-141E Only,
- \$2 CDE-141E(Arabia language) Only,
- \$3 CDE-141ETH Only,
- \$4 CDE-141C Only,
- %1 CDE-140 Only,
- %2 CDE-170R Only,
- %3 CDE-170RR Only,
- %4 CDE-170RM Only,
- &1 CDE-140E Only,
- &2 CDE-140E(Arabia language) Only,
- &3 CDE-140ETH Only,
- &4 CDE-140C Only,

Others:Common.

NOTE:The part that has not PART NUMBER will not be supplied.

MODEL	Symbol No.	Parts No.	Description
	SW800	40T15494Y18	SW,DETCT SPVG1302-E6

Mark Model Code

- #1 CDE-141 Only,
- #2 CDE-171R Only,
- #3 CDE-171RR Only,
- #4 CDE-171RM Only,
- #5 CDE-142E Only,
- \$1 CDE-141E Only,
- \$2 CDE-141E(Arabia language) Only,
- \$3 CDE-141ETH Only,
- \$4 CDE-141C Only,
- %1 CDE-140 Only,
- %2 CDE-170R Only,
- %3 CDE-170RR Only,
- %4 CDE-170RM Only,
- &1 CDE-140E Only,
- &2 CDE-140E(Arabia language) Only,
- &3 CDE-140ETH Only,
- &4 CDE-140C Only,

Others:Common.

NOTE:The part that has not PART NUMBER will not be supplied.

Packing Method View

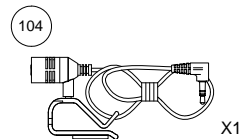
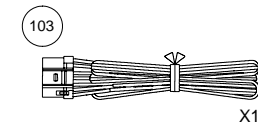
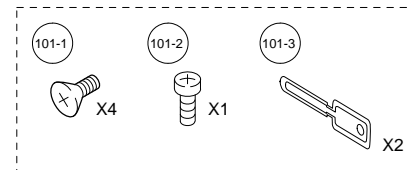
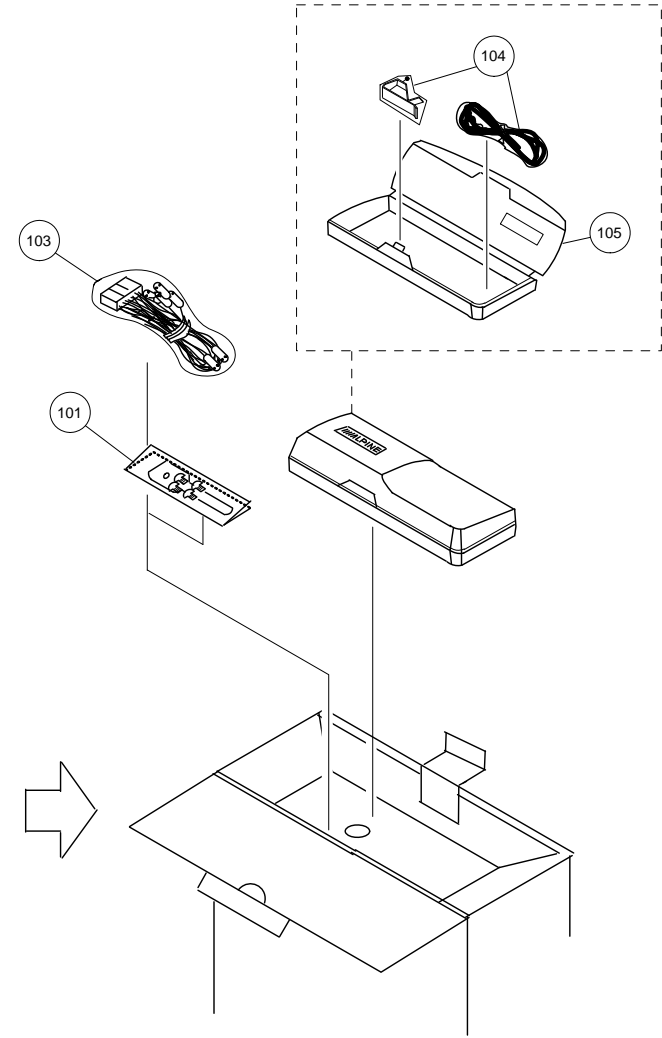
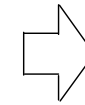
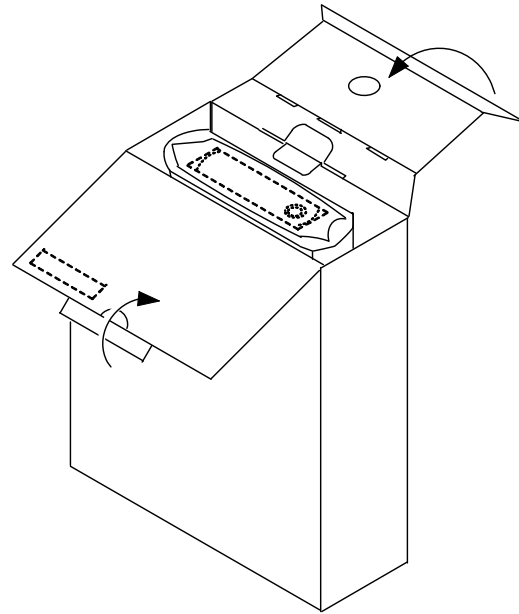
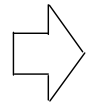
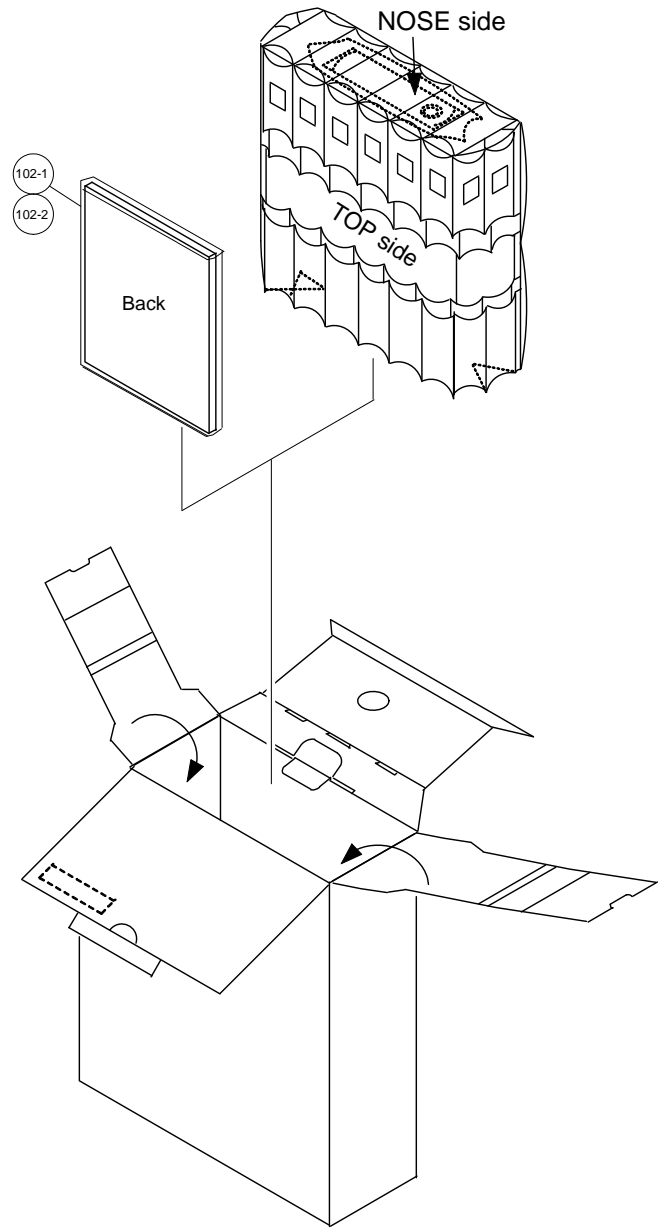

MODEL	Symbol No.	Parts No.	Description
	101-1	03S60820Y16	SCR,MCH 5X8 ZN A
	101-2	03S60824Y01	SCR,WEV 1.7X4 ZN A
	101-3	07-24382Z01	BKT,RELEASE
#1	102-1	68-10334Z54	O/M-CDROM AOTH
#2	102-1	68-10334Z54	O/M-CDROM AOTH
\$1	102-1	68-21627Z80	O/M AOAP AOTH
\$2	102-1	68-21627Z81	O/M AOAP AOTH
%1	102-1	68-21627Z80	O/M AOAP AOTH
&1	102-1	68-21627Z82	O/M AOCH AOTH
#1	102-2	68-21627Z77	C/N-QRG AOAM AOTH
#2	102-2	68-21627Z77	C/N-QRG AOAM AOTH
#1	103	09-25214Z01	ASSY,ANIC-0081-01A
#2	103	09-25214Z01	ASSY,ANIC-0081-01A
\$1	103	09-25214Z02	ASSY,ANIC-0081-02A
\$2	103	09-25214Z02	ASSY,ANIC-0081-02A
%1	103	09-25214Z02	ASSY,ANIC-0081-02A
&1	103	09-25214Z01	ASSY,ANIC-0081-01A
	104	50-14386Z03	ASSY,LYS-M9750-FUL
#1	105	15-24676Z01	CARRYING,CASE ASSY
#2	105	15-24676Z01	CARRYING,CASE ASSY
\$1	105	15-24676Z01	CARRYING,CASE ASSY
\$2	105	15-24676Z01	CARRYING,CASE ASSY
%1	105	15-24676Z01	CARRYING,CASE ASSY

Mark Model Code
CDE-SXM145BT Only,

#1

#2 CDE-143BT Only,

\$1 CDE-143EBT Only,

\$2 CDE-143EBT(Arabia language) Only,

%1 CDE-143EBTTH Only,

&1 CDE-143CBT Only,

Others:Common.

NOTE:The part that has not PART NUMBER will not be supplied

P.W.Board	MIS	MODEL	Ref.	Parts No.	Parts Name
MAIN-P.W.Board			ANT101	09T25015Y01	ANT,RECEPTACLE -DB
MAIN-P.W.Board			C101	08S35349Y16	CAP,CER 105K-B1A -CP
MAIN-P.W.Board			C103	08S45231Y38	CAP,CER 102J-CH1E-CP
MAIN-P.W.Board			C104	08S35374W12	CAP,CER 106K-B0J -CP
MAIN-P.W.Board			C105	08S35374W12	CAP,CER 106K-B0J -CP
MAIN-P.W.Board			C106	08S35374W12	CAP,CER 106K-B0J -CP
MAIN-P.W.Board			C107	08S35374W12	CAP,CER 106K-B0J -CP
MAIN-P.W.Board			C108	08S45231Y38	CAP,CER 102J-CH1E-CP
MAIN-P.W.Board			C109	08S45676W65	CAP,CER.222K-B1H -CP
MAIN-P.W.Board			C110	08S35374W12	CAP,CER 106K-B0J -CP
MAIN-P.W.Board			C111	08S35374W12	CAP,CER 106K-B0J -CP
MAIN-P.W.Board			C112	08S35374W12	CAP,CER 106K-B0J -CP
MAIN-P.W.Board			C114	08S45232Y17	CAP,CER 104K-B0J -CP
MAIN-P.W.Board			C115	08S35374W12	CAP,CER 106K-B0J -CP
MAIN-P.W.Board			C116	08S45231Y06	CAP,CER 3R0C-CJ1H-CP
MAIN-P.W.Board			C117	08S45677W60	CAP,CER 102J-CH1H-CP
MAIN-P.W.Board			C118	08S45232Y17	CAP,CER 104K-B0J -CP
MAIN-P.W.Board			C119	08S65670Y01	CAP,CER 106KX5R1C-CP
MAIN-P.W.Board			C120	08S45232Y17	CAP,CER 104K-B0J -CP
MAIN-P.W.Board			C121	08S45232Y05	CAP,CER 102K-B1H -CP
MAIN-P.W.Board			C122	08S35349Y17	CAP,CER 225K-B0J -CP
MAIN-P.W.Board			C123	08S35374W11	CAP,CER 475K-B0J -CP
MAIN-P.W.Board			C125	08S45232Y17	CAP,CER 104K-B0J -CP
MAIN-P.W.Board			C126	08S45232Y17	CAP,CER 104K-B0J -CP
MAIN-P.W.Board			C127	08S45232Y08	CAP,CER 332K-B1H -CP
MAIN-P.W.Board			C128	08S45232Y05	CAP,CER 102K-B1H -CP
MAIN-P.W.Board			C129	08S45232Y05	CAP,CER 102K-B1H -CP
MAIN-P.W.Board			C131	08S45677W34	CAP,CER.82RJ-CH1H-CP
MAIN-P.W.Board			C132	08S45231Y17	CAP,CER 22RJ-CH1H-CP
MAIN-P.W.Board			C141	08S45231Y25	CAP,CER 101J-CH1H-CP
MAIN-P.W.Board			C142	08S45231Y13	CAP,CER 10RD-CH1H-CP
MAIN-P.W.Board			C143	08S45232Y03	CAP,CER 471K-B1H -CP
MAIN-P.W.Board			C145	08S82122F61	CAP,CER.102J-CH1H-CP
MAIN-P.W.Board			C153	08S45231Y38	CAP,CER 102J-CH1E-CP
MAIN-P.W.Board			C154	08S45231Y16	CAP,CER 18RJ-CH1H-CP
MAIN-P.W.Board			C155	08S45232Y07	CAP,CER 222K-B1H -CP
MAIN-P.W.Board			C160	08S45676W73	CAP,CER.103K-B1H -CP
MAIN-P.W.Board			C161	08S45676W73	CAP,CER.103K-B1H -CP

Mark Model Code
CDE-SXM145BT Only,

#1

#2 CDE-143BT Only,

\$1 CDE-143EBT Only,

\$2 CDE-143EBT(Arabia language) Only,

%1 CDE-143EBTTH Only,

&1 CDE-143CBT Only,

Others:Common.

NOTE:The part that has not PART NUMBER will not be supplied

P.W.Board	MIS	MODEL	Ref.	Parts No.	Parts Name
MAIN-P.W.Board			C162	08S65668Y05	CAP,CER 224KX5R1A-CP
MAIN-P.W.Board			C163	08S45231Y11	CAP,CER 8R0D-CH1H-CP
MAIN-P.W.Board			C164	08S45231Y11	CAP,CER 8R0D-CH1H-CP
MAIN-P.W.Board			C165	08S45231Y38	CAP,CER 102J-CH1E-CP
MAIN-P.W.Board			C166	08S65670Y01	CAP,CER 106KX5R1C-CP
MAIN-P.W.Board			C167	08S45232Y17	CAP,CER 104K-B0J -CP
MAIN-P.W.Board			C168	08S45232Y17	CAP,CER 104K-B0J -CP
MAIN-P.W.Board			C169	08S45231Y38	CAP,CER 102J-CH1E-CP
MAIN-P.W.Board			C170	08S65670Y01	CAP,CER 106KX5R1C-CP
MAIN-P.W.Board		#1	C171	08S35374W12	CAP,CER 106K-B0J -CP
MAIN-P.W.Board		#1	C172	08S35374W12	CAP,CER 106K-B0J -CP
MAIN-P.W.Board		#1	C173	08S35374W12	CAP,CER 106K-B0J -CP
MAIN-P.W.Board		#1	C174	08S35374W12	CAP,CER 106K-B0J -CP
MAIN-P.W.Board		#1	C175	08S45231Y38	CAP,CER 102J-CH1E-CP
MAIN-P.W.Board		#1	C176	08S45231Y38	CAP,CER 102J-CH1E-CP
MAIN-P.W.Board		#1	C302	08S35350Y04	CAP,CER 105K-B1C -CP
MAIN-P.W.Board		#2	C302	08S35350Y04	CAP,CER 105K-B1C -CP
MAIN-P.W.Board			C305	08S65669Y03	CAP,CER 224KX7R1H-CP
MAIN-P.W.Board			C307	08S65669Y03	CAP,CER 224KX7R1H-CP
MAIN-P.W.Board			C309	08S65676Y07	CAP,CER 225K-X7R1ECP
MAIN-P.W.Board			C310	08S65676Y07	CAP,CER 225K-X7R1ECP
MAIN-P.W.Board			C311	08S65669Y03	CAP,CER 224KX7R1H-CP
MAIN-P.W.Board			C312	08S45677W54	CAP,CER 561J-CH1H-CP
MAIN-P.W.Board			C313	08S45677W46	CAP,CER 271J-CH1H-CP
MAIN-P.W.Board			C314	08S45677W46	CAP,CER 271J-CH1H-CP
MAIN-P.W.Board			C315	08S45677W54	CAP,CER 561J-CH1H-CP
MAIN-P.W.Board			C316	08S65669Y03	CAP,CER 224KX7R1H-CP
MAIN-P.W.Board			C318	08S65669Y03	CAP,CER 224KX7R1H-CP
MAIN-P.W.Board			C319	08S45676W73	CAP,CER.103K-B1H -CP
MAIN-P.W.Board			C320	08S35350Y04	CAP,CER 105K-B1C -CP
MAIN-P.W.Board			C321	08S65669Y03	CAP,CER 224KX7R1H-CP
MAIN-P.W.Board			C322	08S65669Y03	CAP,CER 224KX7R1H-CP
MAIN-P.W.Board			C323	08S65669Y03	CAP,CER 224KX7R1H-CP
MAIN-P.W.Board			C324	08S65669Y03	CAP,CER 224KX7R1H-CP
MAIN-P.W.Board			C325	08S35350Y04	CAP,CER 105K-B1C -CP
MAIN-P.W.Board			C327	08S45232Y14	CAP,CER 333K-B1C -CP
MAIN-P.W.Board			C501	08S45676W85	CAP,CER 104K-B1C -CP
MAIN-P.W.Board			C502	08S45676W85	CAP,CER 104K-B1C -CP

Mark Model Code
CDE-SXM145BT Only,

#1

#2 CDE-143BT Only,

\$1 CDE-143EBT Only,

\$2 CDE-143EBT(Arabia language) Only,

%1 CDE-143EBTTH Only,

&1 CDE-143CBT Only,

Others:Common.

NOTE:The part that has not PART NUMBER will not be supplied

P.W.Board	MIS	MODEL	Ref.	Parts No.	Parts Name
MAIN-P.W.Board			C503	08S45676W85	CAP,CER 104K-B1C -CP
MAIN-P.W.Board			C506	08S65668Y05	CAP,CER 224KX5R1A-CP
MAIN-P.W.Board			C507	08S45677W60	CAP,CER 102J-CH1H-CP
MAIN-P.W.Board			C514	08S45232Y11	CAP,CER 103K-B1C -CP
MAIN-P.W.Board			C518	08S45676W85	CAP,CER 104K-B1C -CP
MAIN-P.W.Board			C519	08S45676W65	CAP,CER.222K-B1H -CP
MAIN-P.W.Board			C523	08S45232Y17	CAP,CER 104K-B0J -CP
MAIN-P.W.Board			C524	08S45676W85	CAP,CER 104K-B1C -CP
MAIN-P.W.Board			C525	08S45676W85	CAP,CER 104K-B1C -CP
MAIN-P.W.Board			C526	08S45676W85	CAP,CER 104K-B1C -CP
MAIN-P.W.Board			C527	08S45676W85	CAP,CER 104K-B1C -CP
MAIN-P.W.Board			C528	08S45676W85	CAP,CER 104K-B1C -CP
MAIN-P.W.Board			C529	08S45676W85	CAP,CER 104K-B1C -CP
MAIN-P.W.Board			C530	08S45676W85	CAP,CER 104K-B1C -CP
MAIN-P.W.Board			C531	08S45676W85	CAP,CER 104K-B1C -CP
MAIN-P.W.Board			C532	08S45676W85	CAP,CER 104K-B1C -CP
MAIN-P.W.Board			C533	08S45676W85	CAP,CER 104K-B1C -CP
MAIN-P.W.Board			C534	08S45676W85	CAP,CER 104K-B1C -CP
MAIN-P.W.Board			C535	08S45232Y21	CAP,CER 104K-B1A-CP
MAIN-P.W.Board			C536	08S45232Y21	CAP,CER 104K-B1A-CP
MAIN-P.W.Board			C537	08S45676W85	CAP,CER 104K-B1C -CP
MAIN-P.W.Board			C538	08S45676W85	CAP,CER 104K-B1C -CP
MAIN-P.W.Board			C539	08S45676W85	CAP,CER 104K-B1C -CP
MAIN-P.W.Board			C540	08S45676W85	CAP,CER 104K-B1C -CP
MAIN-P.W.Board			C541	08S45676W85	CAP,CER 104K-B1C -CP
MAIN-P.W.Board			C542	08S45676W85	CAP,CER 104K-B1C -CP
MAIN-P.W.Board			C543	08S45676W85	CAP,CER 104K-B1C -CP
MAIN-P.W.Board			C544	08S45676W85	CAP,CER 104K-B1C -CP
MAIN-P.W.Board			C545	08S45676W85	CAP,CER 104K-B1C -CP
MAIN-P.W.Board			C546	08S45676W85	CAP,CER 104K-B1C -CP
MAIN-P.W.Board			C547	08S45231Y15	CAP,CER 15RJ-CH1H-CP
MAIN-P.W.Board			C548	08S45231Y15	CAP,CER 15RJ-CH1H-CP
MAIN-P.W.Board			C549	08S65668Y05	CAP,CER 224KX5R1A-CP
MAIN-P.W.Board			C550	08S35349Y16	CAP,CER 105K-B1A -CP
MAIN-P.W.Board			C551	08S35349Y16	CAP,CER 105K-B1A -CP
MAIN-P.W.Board			C552	08S65669Y03	CAP,CER 224KX7R1H-CP
MAIN-P.W.Board			C554	08S45676W85	CAP,CER 104K-B1C -CP
MAIN-P.W.Board			C555	08S45676W69	CAP,CER.472K-B1H -CP

Mark Model Code
CDE-SXM145BT Only,

#1

#2 CDE-143BT Only,

\$1 CDE-143EBT Only,

\$2 CDE-143EBT(Arabia language) Only,

%1 CDE-143EBTTH Only,

&1 CDE-143CBT Only,

Others:Common.

NOTE:The part that has not PART NUMBER will not be supplied

P.W.Board	MIS	MODEL	Ref.	Parts No.	Parts Name
MAIN-P.W.Board			C556	08S45232Y03	CAP,CER 471K-B1H -CP
MAIN-P.W.Board			C561	08S45676W73	CAP,CER.103K-B1H -CP
MAIN-P.W.Board			C601	08S45232Y05	CAP,CER 102K-B1H -CP
MAIN-P.W.Board			C602	08S45231Y13	CAP,CER 10RD-CH1H-CP
MAIN-P.W.Board			C603	08S35374W12	CAP,CER 106K-B0J -CP
MAIN-P.W.Board			C604	08S45232Y05	CAP,CER 102K-B1H -CP
MAIN-P.W.Board			C605	08S45232Y05	CAP,CER 102K-B1H -CP
MAIN-P.W.Board			C606	08S35374W12	CAP,CER 106K-B0J -CP
MAIN-P.W.Board			C607	08S35374W12	CAP,CER 106K-B0J -CP
MAIN-P.W.Board			C608	08S35374W12	CAP,CER 106K-B0J -CP
MAIN-P.W.Board			C609	08S45232Y17	CAP,CER 104K-B0J -CP
MAIN-P.W.Board			C610	08S35374W12	CAP,CER 106K-B0J -CP
MAIN-P.W.Board			C611	08S45232Y17	CAP,CER 104K-B0J -CP
MAIN-P.W.Board			C612	08S45232Y05	CAP,CER 102K-B1H -CP
MAIN-P.W.Board			C613	08S45231Y13	CAP,CER 10RD-CH1H-CP
MAIN-P.W.Board			C614	08S45232Y05	CAP,CER 102K-B1H -CP
MAIN-P.W.Board			C615	08S45231Y13	CAP,CER 10RD-CH1H-CP
MAIN-P.W.Board			C616	08S35349Y12	CAP,CER 105K-B0J -CP
MAIN-P.W.Board			C617	08S45232Y05	CAP,CER 102K-B1H -CP
MAIN-P.W.Board			C618	08S35349Y12	CAP,CER 105K-B0J -CP
MAIN-P.W.Board			C619	08S35349Y12	CAP,CER 105K-B0J -CP
MAIN-P.W.Board			C620	08S45232Y17	CAP,CER 104K-B0J -CP
MAIN-P.W.Board			C621	08S45232Y17	CAP,CER 104K-B0J -CP
MAIN-P.W.Board			C623	08S45231Y04	CAP,CER 1R5C-CK1H-CP
MAIN-P.W.Board			C624	08S45231Y15	CAP,CER 15RJ-CH1H-CP
MAIN-P.W.Board			C625	08S45231Y15	CAP,CER 15RJ-CH1H-CP
MAIN-P.W.Board			C626	08S45232Y17	CAP,CER 104K-B0J -CP
MAIN-P.W.Board			C704	08S45232Y14	CAP,CER 333K-B1C -CP
MAIN-P.W.Board			C705	08S45232Y17	CAP,CER 104K-B0J -CP
MAIN-P.W.Board			C706	08S35374W12	CAP,CER 106K-B0J -CP
MAIN-P.W.Board			C707	08S35349Y17	CAP,CER 225K-B0J -CP
MAIN-P.W.Board			C708	08S45231Y15	CAP,CER 15RJ-CH1H-CP
MAIN-P.W.Board			C709	08S45232Y17	CAP,CER 104K-B0J -CP
MAIN-P.W.Board			C710	08S45232Y08	CAP,CER 332K-B1H -CP
MAIN-P.W.Board			C711	08S45676W69	CAP,CER.472K-B1H -CP
MAIN-P.W.Board			C712	08S45232Y12	CAP,CER 153K-B1C -CP
MAIN-P.W.Board			C713	08S45232Y17	CAP,CER 104K-B0J -CP
MAIN-P.W.Board			C714	08S45232Y17	CAP,CER 104K-B0J -CP

Mark Model Code
CDE-SXM145BT Only,

#1

#2 CDE-143BT Only,

\$1 CDE-143EBT Only,

\$2 CDE-143EBT(Arabia language) Only,

%1 CDE-143EBTTH Only,

&1 CDE-143CBT Only,

Others:Common.

NOTE:The part that has not PART NUMBER will not be supplied

P.W.Board	MIS	MODEL	Ref.	Parts No.	Parts Name
MAIN-P.W.Board			C715	08S45232Y17	CAP,CER 104K-B0J -CP
MAIN-P.W.Board			C716	08S45232Y17	CAP,CER 104K-B0J -CP
MAIN-P.W.Board			C717	08S45232Y14	CAP,CER 333K-B1C -CP
MAIN-P.W.Board			C718	08S45232Y14	CAP,CER 333K-B1C -CP
MAIN-P.W.Board			C719	08S45232Y08	CAP,CER 332K-B1H -CP
MAIN-P.W.Board			C720	08S45676W73	CAP,CER.103K-B1H -CP
MAIN-P.W.Board			C721	08S45232Y14	CAP,CER 333K-B1C -CP
MAIN-P.W.Board			C722	08S45232Y11	CAP,CER 103K-B1C -CP
MAIN-P.W.Board			C723	08S45232Y17	CAP,CER 104K-B0J -CP
MAIN-P.W.Board			C724	08S45231Y21	CAP,CER 47RJ-CH1H-CP
MAIN-P.W.Board			C725	08S45232Y12	CAP,CER 153K-B1C -CP
MAIN-P.W.Board			C726	08S45232Y07	CAP,CER 222K-B1H -CP
MAIN-P.W.Board			C727	08S45232Y17	CAP,CER 104K-B0J -CP
MAIN-P.W.Board			C728	08S45232Y14	CAP,CER 333K-B1C -CP
MAIN-P.W.Board			C729	08S45232Y05	CAP,CER 102K-B1H -CP
MAIN-P.W.Board			C730	08S35374W12	CAP,CER 106K-B0J -CP
MAIN-P.W.Board			C731	08S45232Y08	CAP,CER 332K-B1H -CP
MAIN-P.W.Board			C732	08S35374W12	CAP,CER 106K-B0J -CP
MAIN-P.W.Board			C733	08S45231Y15	CAP,CER 15RJ-CH1H-CP
MAIN-P.W.Board			C734	08S45232Y17	CAP,CER 104K-B0J -CP
MAIN-P.W.Board			C735	08S45232Y17	CAP,CER 104K-B0J -CP
MAIN-P.W.Board			C736	08S45676W73	CAP,CER.103K-B1H -CP
MAIN-P.W.Board			C737	08S35374W12	CAP,CER 106K-B0J -CP
MAIN-P.W.Board			C738	08S45231Y38	CAP,CER 102J-CH1E-CP
MAIN-P.W.Board			C739	08S65669Y03	CAP,CER 224KX7R1H-CP
MAIN-P.W.Board			C740	08S45231Y28	CAP,CER 181J-CH1H-CP
MAIN-P.W.Board			C741	08S45676W80	CAP,CER 223K-B1E -CP
MAIN-P.W.Board			C744	08S65669Y03	CAP,CER 224KX7R1H-CP
MAIN-P.W.Board			C745	08S65669Y03	CAP,CER 224KX7R1H-CP
MAIN-P.W.Board			C746	08S65668Y05	CAP,CER 224KX5R1A-CP
MAIN-P.W.Board			C747	08S65668Y05	CAP,CER 224KX5R1A-CP
MAIN-P.W.Board			C748	08S45232Y05	CAP,CER 102K-B1H -CP
MAIN-P.W.Board			C749	08S45232Y08	CAP,CER 332K-B1H -CP
MAIN-P.W.Board			C750	08S45232Y13	CAP,CER 223K-B1C -CP
MAIN-P.W.Board			C752	08S45676W85	CAP,CER 104K-B1C -CP
MAIN-P.W.Board			C753	08S65669Y03	CAP,CER 224KX7R1H-CP
MAIN-P.W.Board			C754	08S45231Y15	CAP,CER 15RJ-CH1H-CP
MAIN-P.W.Board			C755	08S45231Y15	CAP,CER 15RJ-CH1H-CP

Mark Model Code
CDE-SXM145BT Only,

#1

#2 CDE-143BT Only,

\$1 CDE-143EBT Only,

\$2 CDE-143EBT(Arabia language) Only,

%1 CDE-143EBTTH Only,

&1 CDE-143CBT Only,

Others:Common.

NOTE:The part that has not PART NUMBER will not be supplied

P.W.Board	MIS	MODEL	Ref.	Parts No.	Parts Name
MAIN-P.W.Board			C756	08S45231Y15	CAP,CER 15RJ-CH1H-CP
MAIN-P.W.Board			C801	08S45232Y21	CAP,CER 104K-B1A-CP
MAIN-P.W.Board			C802	08S45232Y12	CAP,CER 153K-B1C -CP
MAIN-P.W.Board			C803	08S45676W74	CAP,CER 123K-B1H -CP
MAIN-P.W.Board			C804	08S45232Y01	CAP,CER 221K-B1H -CP
MAIN-P.W.Board			C805	08S45232Y07	CAP,CER 222K-B1H -CP
MAIN-P.W.Board			C806	08S45232Y21	CAP,CER 104K-B1A-CP
MAIN-P.W.Board			C807	08S35349Y16	CAP,CER 105K-B1A -CP
MAIN-P.W.Board			C808	08S65670Y07	CAP,CER 105KX5R1H-CP
MAIN-P.W.Board			C809	08S35349Y16	CAP,CER 105K-B1A -CP
MAIN-P.W.Board			C810	08S65669Y03	CAP,CER 224KX7R1H-CP
MAIN-P.W.Board			C811	08S65669Y03	CAP,CER 224KX7R1H-CP
MAIN-P.W.Board			C812	08S65669Y03	CAP,CER 224KX7R1H-CP
MAIN-P.W.Board			C813	08S65669Y03	CAP,CER 224KX7R1H-CP
MAIN-P.W.Board			C814	08S65669Y03	CAP,CER 224KX7R1H-CP
MAIN-P.W.Board			C815	08S65128F88	CAP,CER 104K-B1H -CP
MAIN-P.W.Board			C817	08S65669Y03	CAP,CER 224KX7R1H-CP
MAIN-P.W.Board			C818	08S65669Y03	CAP,CER 224KX7R1H-CP
MAIN-P.W.Board			C819	08S65669Y03	CAP,CER 224KX7R1H-CP
MAIN-P.W.Board			C820	08S65669Y03	CAP,CER 224KX7R1H-CP
MAIN-P.W.Board			C821	08S65669Y03	CAP,CER 224KX7R1H-CP
MAIN-P.W.Board			C822	08S65669Y03	CAP,CER 224KX7R1H-CP
MAIN-P.W.Board			C824	08S45676W73	CAP,CER.103K-B1H -CP
MAIN-P.W.Board			C825	08S45676W89	CAP,CER 473K-B1E -CP
MAIN-P.W.Board			C826	08S65669Y03	CAP,CER 224KX7R1H-CP
MAIN-P.W.Board			C827	08S65669Y03	CAP,CER 224KX7R1H-CP
MAIN-P.W.Board			C828	08S65669Y03	CAP,CER 224KX7R1H-CP
MAIN-P.W.Board			C829	08S45676W85	CAP,CER 104K-B1C -CP
MAIN-P.W.Board			C830	08S65669Y03	CAP,CER 224KX7R1H-CP
MAIN-P.W.Board			C831	08S45232Y17	CAP,CER 104K-B0J -CP
MAIN-P.W.Board			C832	08S45232Y17	CAP,CER 104K-B0J -CP
MAIN-P.W.Board			C833	08S45232Y08	CAP,CER 332K-B1H -CP
MAIN-P.W.Board			C834	08S45232Y08	CAP,CER 332K-B1H -CP
MAIN-P.W.Board			C835	08S65669Y03	CAP,CER 224KX7R1H-CP
MAIN-P.W.Board			C836	08S65669Y03	CAP,CER 224KX7R1H-CP
MAIN-P.W.Board			C838	08S65670Y07	CAP,CER 105KX5R1H-CP
MAIN-P.W.Board			C839	08S45231Y25	CAP,CER 101J-CH1H-CP
MAIN-P.W.Board			C840	08S45676W85	CAP,CER 104K-B1C -CP

Mark Model Code
CDE-SXM145BT Only,

#1

#2 CDE-143BT Only,

\$1 CDE-143EBT Only,



\$2 CDE-143EBT(Arabia language) Only,

%1 CDE-143EBTTH Only,

&1 CDE-143CBT Only,

Others:Common.

NOTE:The part that has not PART NUMBER will not be supplied

P.W.Board	MIS	MODEL	Ref.	Parts No.	Parts Name
MAIN-P.W.Board			C901	08S65668Y05	CAP,CER 224KX5R1A-CP
MAIN-P.W.Board			C902	08S65669Y03	CAP,CER 224KX7R1H-CP
MAIN-P.W.Board			C903	08S65669Y03	CAP,CER 224KX7R1H-CP
MAIN-P.W.Board		#1	C905	08S45676W85	CAP,CER 104K-B1C -CP
MAIN-P.W.Board		#2	C905	08S45676W85	CAP,CER 104K-B1C -CP
MAIN-P.W.Board			C906	08S45232Y11	CAP,CER 103K-B1C -CP
MAIN-P.W.Board			C907	08S45232Y13	CAP,CER 223K-B1C -CP
MAIN-P.W.Board			C908	08S45676W65	CAP,CER.222K-B1H -CP
MAIN-P.W.Board		#1	C911	08S65668Y05	CAP,CER 224KX5R1A-CP
MAIN-P.W.Board		#1	C913	08S45676W65	CAP,CER.222K-B1H -CP
MAIN-P.W.Board		#1	C917	08S45539Y04	CAP,CER 103KX7R2J-CP
MAIN-P.W.Board			CB701	09T75287Y24	FFC,IMSA9631S-24Y-ED
MAIN-P.W.Board			CH501	09-18738Z01	BTB,DF20-S -DB
MAIN-P.W.Board			D101	48-12230Z01	DIO,KDS226-RTK -CP
MAIN-P.W.Board			D302	48T75446Y01	DIO,RR264M-400 -CP
MAIN-P.W.Board			D303	48T75527Y01	DIO,1SR154-400 -E1
MAIN-P.W.Board			D304	48-07016Z01	DIO,KDS181-RTK -CP
MAIN-P.W.Board			D306	48-07016Z01	DIO,KDS181-RTK -CP
MAIN-P.W.Board			D307	48-05965Z01	DIO,1SS361-L -CP
MAIN-P.W.Board			D309	48-05828Z01	DIO,1N5406G-04 -
MAIN-P.W.Board			D800	48-07015Z01	DIO,KDS160-RTK -CP
MAIN-P.W.Board			D802	48T75527Y01	DIO,1SR154-400 -E1
MAIN-P.W.Board			D803	48T75527Y01	DIO,1SR154-400 -E1
MAIN-P.W.Board			D804	48-07015Z01	DIO,KDS160-RTK -CP
MAIN-P.W.Board			D807	48-05164Z01	DIO,1SS352-TPH3 -CP
MAIN-P.W.Board			D901	48-07016Z02	DIO,KDS184-RTK -CP
MAIN-P.W.Board		#1	DIN901	09-18874Z01	DIN,TCS7718-012117DB
MAIN-P.W.Board			E301	23T75346W03	CAP,X-PRO 332-1C +
MAIN-P.W.Board			E302	23T75234Y06	CAP,MAR 22R-1C-E55E3
MAIN-P.W.Board			E303	23T75234Y06	CAP,MAR 22R-1C-E55E3
MAIN-P.W.Board			E304	23T75234Y20	CAP,MAR 22R-1E-F55E6
MAIN-P.W.Board			E305	23S65134W52	CAP,ELY 3R3-1V(3)-E2
MAIN-P.W.Board			E306	23S65134W52	CAP,ELY 3R3-1V(3)-E2
MAIN-P.W.Board			E309	23S65134W52	CAP,ELY 3R3-1V(3)-E2
MAIN-P.W.Board			E310	23S65134W52	CAP,ELY 3R3-1V(3)-E2
MAIN-P.W.Board			E311	23S65134W34	CAP,ELY 47R-1C(6)-E6
MAIN-P.W.Board			E312	23S65134W53	CAP,ELY 4R7-1V(4)-E2
MAIN-P.W.Board			E313	23S65134W53	CAP,ELY 4R7-1V(4)-E2

Mark Model Code
CDE-SXM145BT Only,

#1

#2 CDE-143BT Only,

\$1 CDE-143EBT Only,

\$2 CDE-143EBT(Arabia language) Only,

%1 CDE-143EBTTH Only,

&1 CDE-143CBT Only,

Others:Common.

NOTE:The part that has not PART NUMBER will not be supplied

P.W.Board	MIS	MODEL	Ref.	Parts No.	Parts Name
MAIN-P.W.Board			E314	23S65134W53	CAP,ELY 4R7-1V(4)-E2
MAIN-P.W.Board			E315	23S65134W53	CAP,ELY 4R7-1V(4)-E2
MAIN-P.W.Board			E316	23T75234Y06	CAP,MAR 22R-1C-E55E3
MAIN-P.W.Board			E317	23S65134W53	CAP,ELY 4R7-1V(4)-E2
MAIN-P.W.Board			E500	23S65134W51	CAP,ELY 2R2-1V(3)-E2
MAIN-P.W.Board			E501	23S65134W36	CAP,ELY 221-1C(8)-EA
MAIN-P.W.Board			E502	23S65134W81	CAP,ELY 22R-1C(4)-E2
MAIN-P.W.Board			E701	23S65134W34	CAP,ELY 47R-1C(6)-E6
MAIN-P.W.Board			E702	23S65134W34	CAP,ELY 47R-1C(6)-E6
MAIN-P.W.Board			E703	23S65134W35	CAP,ELY 101-1C(8)-E6
MAIN-P.W.Board			E704	23T65679Y11	CAP,CD 47R-0J -E2
MAIN-P.W.Board			E705	23S65134W35	CAP,ELY 101-1C(8)-E6
MAIN-P.W.Board			E803	23T65114Y20	CAP,FK 101-1C-D -E6
MAIN-P.W.Board			E804	23S65134W35	CAP,ELY 101-1C(8)-E6
MAIN-P.W.Board			E805	23S65134W35	CAP,ELY 101-1C(8)-E6
MAIN-P.W.Board			E806	23S65134W35	CAP,ELY 101-1C(8)-E6
MAIN-P.W.Board			E807	23S65134W80	CAP,ELY 10R-1C(3)-E2
MAIN-P.W.Board			E808	23S65134W80	CAP,ELY 10R-1C(3)-E2
MAIN-P.W.Board			E809	23S65134W54	CAP,ELY 10R-1V(5)-E3
MAIN-P.W.Board			E810	23T65114Y15	CAP,FK 681-1A-F -EA
MAIN-P.W.Board			E811	23S65134W24	CAP,ELY 221-1A(8)-E6
MAIN-P.W.Board			E812	23T75234Y19	CAP,MAR 101-1C-H63E6
MAIN-P.W.Board			E813	23S65134W47	CAP,ELY 101-1E(8)-E6
MAIN-P.W.Board			E814	23S65134W44	CAP,ELY 22R-1E(6)-E6
MAIN-P.W.Board			E815	23S65134W26	CAP,ELY 471-1A(8)-EA
MAIN-P.W.Board			E816	23S65134W24	CAP,ELY 221-1A(8)-E6
MAIN-P.W.Board			E818	23S65134W47	CAP,ELY 101-1E(8)-E6
MAIN-P.W.Board			E819	23S65134W80	CAP,ELY 10R-1C(3)-E2
MAIN-P.W.Board			E820	23S75244Y13	CAP,ELY 471-1A -EA
MAIN-P.W.Board			E821	23-12290Z30	CAP,FP 331-1E-F -EA
MAIN-P.W.Board			E822	23S65134W80	CAP,ELY 10R-1C(3)-E2
MAIN-P.W.Board			E823	23S75244Y19	CAP,ELY 101-1C -E6
MAIN-P.W.Board			E824	23S75244Y28	CAP,ELY 101-1E -E6
MAIN-P.W.Board			E825	23S75244Y18	CAP,ELY 47R-1C -E3
MAIN-P.W.Board			E901	23S65134W81	CAP,ELY 22R-1C(4)-E2
MAIN-P.W.Board			E902	23S65134W24	CAP,ELY 221-1A(8)-E6
MAIN-P.W.Board		#1	E903	23S65134W80	CAP,ELY 10R-1C(3)-E2
MAIN-P.W.Board			IC101	51-22873Z01	TEA6636HW/V103 -QT

Mark Model Code
CDE-SXM145BT Only,

#1

#2 CDE-143BT Only,

\$1 CDE-143EBT Only,

\$2 CDE-143EBT(Arabia language) Only,

%1 CDE-143EBTTH Only,

&1 CDE-143CBT Only,

Others:Common.

NOTE:The part that has not PART NUMBER will not be supplied

P.W.Board	MIS	MODEL	Ref.	Parts No.	Parts Name
MAIN-P.W.Board			IC301	51-19762Z01	BD37543FS-E2 -SE9
MAIN-P.W.Board			IC302	51-05314Z01	BA4560RFVM-TR -SE1
MAIN-P.W.Board			IC303	51-18346Z01	TB2986HQ -ZS
MAIN-P.W.Board		#1	IC501	83-22939Z96	13Decola_SXI_All_Soft
MAIN-P.W.Board		#2	IC501	83-24926Z35	13Decola_AE_All_Soft
MAIN-P.W.Board		\$1	IC501	83-24926Z35	13Decola_AE_All_Soft
MAIN-P.W.Board		\$2	IC501	83-24926Z35	13Decola_AE_All_Soft
MAIN-P.W.Board		% 1	IC501	83-24926Z35	13Decola_AE_All_Soft
MAIN-P.W.Board		&1	IC501	83-24926Z35	13Decola_AE_All_Soft
MAIN-P.W.Board		#1	IC504	51-24717Z01	M24512-RMN6TP -SE2
MAIN-P.W.Board		#2	IC504	51-22801Z01	M24C32-WMN6TP -SE2
MAIN-P.W.Board		\$1	IC504	51-22801Z01	M24C32-WMN6TP -SE2
MAIN-P.W.Board		\$2	IC504	51-22801Z01	M24C32-WMN6TP -SE2
MAIN-P.W.Board		% 1	IC504	51-22801Z01	M24C32-WMN6TP -SE2
MAIN-P.W.Board		&1	IC504	51-22801Z01	M24C32-WMN6TP -SE2
MAIN-P.W.Board			IC506	51-24658Z01	TMPM32BC2DFG -QT
MAIN-P.W.Board			IC507	51-23872Z01	AK5701KN -LE2
MAIN-P.W.Board			IC601	51-24902Z01	TC35661IDBG -BE6
MAIN-P.W.Board			IC602	51-24794Z01	BR24T02F-WGE2 -SE2
MAIN-P.W.Board			IC701	51-16202Z03	TC94A92FG301CAPNH-QT
MAIN-P.W.Board			IC702	51-14737Z01	BD8226EFV-E2 -SE6
MAIN-P.W.Board			IC801	51-20097Z02	AN33012UB-VB -SE6
MAIN-P.W.Board			IC802	51-04433Z01	BD12KA5WFP-E2 -NE5
MAIN-P.W.Board			IC803	51-13711Z01	TB2920HQ -ZS
MAIN-P.W.Board			IC804	51-20765Z24	S-1009N30H-M5T2U -CP
MAIN-P.W.Board			IC805	51-06963Z01	NJU7741F15-TE1 -CP
MAIN-P.W.Board			IC806	51-05862Z01	NJM2845DL1-33-TE1NE5
MAIN-P.W.Board			IC807	51-05862Z01	NJM2845DL1-33-TE1NE5
MAIN-P.W.Board			IC808	51-06963Z01	NJU7741F15-TE1 -CP
MAIN-P.W.Board			IC810	51-08580Z01	NJM2886DL3-33TE1-NE5
MAIN-P.W.Board			IC811	51-13565Z03	NJM2856DL3-33TE1-NE5
MAIN-P.W.Board			IC901	51-15224Z01	MFI341S2313 -SE2
MAIN-P.W.Board			IC902	51T93532F05	TC4S01F-TE85L -CP
MAIN-P.W.Board			IC903	51-11433Z01	RT9702AGB -CP
MAIN-P.W.Board		#1	IC904	51-04637Z01	TC74ACT04FT-EL -SE5
MAIN-P.W.Board			JK301	09-25329Z01	RCA,RJ-1346C41-0H0DB
MAIN-P.W.Board		#1	JK901	09-14149Z01	JAC,CK3-3.5-14D -DB
MAIN-P.W.Board		#2	JK901	09-14149Z01	JAC,CK3-3.5-14D -DB

Mark Model Code
CDE-SXM145BT Only,

#1

#2 CDE-143BT Only,

\$1 CDE-143EBT Only,

\$2 CDE-143EBT(Arabia language) Only,

%1 CDE-143EBTTH Only,

&1 CDE-143CBT Only,

Others:Common.

NOTE:The part that has not PART NUMBER will not be supplied

P.W.Board	MIS	MODEL	Ref.	Parts No.	Parts Name
MAIN-P.W.Board	☒	\$1	JK901	09T03156K01	JAC,CK-3.5-14 -DB
MAIN-P.W.Board	☒	\$2	JK901	09T03156K01	JAC,CK-3.5-14 -DB
MAIN-P.W.Board	☒	% 1	JK901	09T03156K01	JAC,CK-3.5-14 -DB
MAIN-P.W.Board	☒	&1	JK901	09T03156K01	JAC,CK-3.5-14 -DB
MAIN-P.W.Board			L101	24T95456W11	FBI,BLM18AG601SH1-CP
MAIN-P.W.Board			L102	24T95458W07	FBI,BLM31PG601SH1-CP
MAIN-P.W.Board			L103	24T95456W11	FBI,BLM18AG601SH1-CP
MAIN-P.W.Board			L104	24T95456W11	FBI,BLM18AG601SH1-CP
MAIN-P.W.Board			L105	24T95456W11	FBI,BLM18AG601SH1-CP
MAIN-P.W.Board			L106	24T45482Y05	IND,LQH31HN R29J -CP
MAIN-P.W.Board			L107	24T25164Y12	IND,FSLM2520 R82J-CP
MAIN-P.W.Board			L108	24T25164Y19	IND,FSLM2520 3R3J-CP
MAIN-P.W.Board			L109	24T55488Y37	IND,LLQ1608 R27J -CP
MAIN-P.W.Board			L110	24T65645Y03	IND,LLM3225 561K -CP
MAIN-P.W.Board			L111	24T65645Y03	IND,LLM3225 561K -CP
MAIN-P.W.Board			L112	24T95459W07	FBI,BLM41PG102SH1-E1
MAIN-P.W.Board			L113	24T95456W11	FBI,BLM18AG601SH1-CP
MAIN-P.W.Board			L114	24T65645Y01	IND,LLM3225 4R7J -CP
MAIN-P.W.Board			L701	24T95456W11	FBI,BLM18AG601SH1-CP
MAIN-P.W.Board			L702	24T95456W07	FBI,BLM18BD102SH1-CP
MAIN-P.W.Board			L703	24T95456W07	FBI,BLM18BD102SH1-CP
MAIN-P.W.Board			L704	24T95456W07	FBI,BLM18BD102SH1-CP
MAIN-P.W.Board			L801	24-05496Z01	IND,SLF12575-H33RMEA
MAIN-P.W.Board		#1	PS901	48-16589Z03	POLY,SW SMD C150F -E2
MAIN-P.W.Board			Q101	48-20742Z01	TR,BCX54 -E2
MAIN-P.W.Board		#1	Q302	48-13000Z05	TR,LTC124EUBFS8-TLCP
MAIN-P.W.Board		#2	Q302	48-13000Z05	TR,LTC124EUBFS8-TLCP
MAIN-P.W.Board			Q303	48T75180Y04	TR,IMH23-T110 -CP
MAIN-P.W.Board			Q305	48T75180Y04	TR,IMH23-T110 -CP
MAIN-P.W.Board			Q306	48-20093Z01	TR,DMC561010R -CP
MAIN-P.W.Board			Q308	48-04929Z02	TR,KRC102S-RTK -CP
MAIN-P.W.Board			Q309	48-04929Z03	TR,KRC103S-RTK -CP
MAIN-P.W.Board			Q310	48T25737Y01	TR,UMD2N-TR -CP
MAIN-P.W.Board			Q701	48-17707Z01	TR,DSA700300L -E2
MAIN-P.W.Board			Q702	48-19949Z01	TR,DRC5143X -CP
MAIN-P.W.Board			Q703	48T55462Y01	TR,2SB1132-QR-100-E2
MAIN-P.W.Board			Q704	48-04940Z17	TR,KRA118S-RTK -CP
MAIN-P.W.Board			Q705	48-13000Z01	TR,LTC114EUBFS8-TLCP

Mark Model Code
CDE-SXM145BT Only,

#1

#2 CDE-143BT Only,

\$1 CDE-143EBT Only,

\$2 CDE-143EBT(Arabia language) Only,

%1 CDE-143EBTTH Only,

&1 CDE-143CBT Only,

Others:Common.

NOTE:The part that has not PART NUMBER will not be supplied

P.W.Board	MIS	MODEL	Ref.	Parts No.	Parts Name
MAIN-P.W.Board			Q801	48-20094Z02	TR,DMA561020R -CP
MAIN-P.W.Board			Q804	48T25737Y01	TR,UMD2N-TR -CP
MAIN-P.W.Board			Q805	48-13000Z01	TR,LTC114EUBFS8-TLCP
MAIN-P.W.Board			Q806	48T15657Y01	TR,2SA1774-TL -CP
MAIN-P.W.Board			Q807	48-19949Z01	TR,DRC5143X -CP
MAIN-P.W.Board			Q808	48-09581Z04	TR,KTA1505S-GRRTK-CP
MAIN-P.W.Board			Q810	48-20288Z01	FET,MTM981400BBF -E2
MAIN-P.W.Board			Q901	48-09583Z04	TR,KTA1504S-GRRTK-CP
MAIN-P.W.Board		#1	Q902	48-09583Z04	TR,KTA1504S-GRRTK-CP
MAIN-P.W.Board		#2	Q902	48-09583Z04	TR,KTA1504S-GRRTK-CP
MAIN-P.W.Board			Q903	48-13000Z01	TR,LTC114EUBFS8-TLCP
MAIN-P.W.Board		#1	Q904	48-19949Z01	TR,DRC5143X -CP
MAIN-P.W.Board		#1	Q905	48T25737Y02	TR,UMD3N-TR -CP
MAIN-P.W.Board			Q906	48-13000Z05	TR,LTC124EUBFS8-TLCP
MAIN-P.W.Board			R101	06S15615Y25	RES,RK 101J 1/16 -CP
MAIN-P.W.Board			R102	06S15616Y23	RES,RK JUMPER1/16-CP
MAIN-P.W.Board			R103	06S15616Y23	RES,RK JUMPER1/16-CP
MAIN-P.W.Board			R107	06S15615Y25	RES,RK 101J 1/16 -CP
MAIN-P.W.Board			R109	06S15615Y25	RES,RK 101J 1/16 -CP
MAIN-P.W.Board			R110	06S15615Y25	RES,RK 101J 1/16 -CP
MAIN-P.W.Board			R111	06S15616Y28	RES,RK 3R3J 1/16 -CP
MAIN-P.W.Board			R113	06S15615Y25	RES,RK 101J 1/16 -CP
MAIN-P.W.Board			R121	06S15616Y23	RES,RK JUMPER1/16-CP
MAIN-P.W.Board			R196	06S65415Y11	RES,RK 68RF 1/16 -CP
MAIN-P.W.Board			R197	06S45348Y38	RES,RK 474F 1/4 -CP
MAIN-P.W.Board			R206	06S45348Y38	RES,RK 474F 1/4 -CP
MAIN-P.W.Board			R207	06S15615Y25	RES,RK 101J 1/16 -CP
MAIN-P.W.Board			R219	06S45674W57	RES,RK 102J 1/10 -CP
MAIN-P.W.Board			R220	06S45674W57	RES,RK 102J 1/10 -CP
MAIN-P.W.Board			R221	06S45674W57	RES,RK 102J 1/10 -CP
MAIN-P.W.Board			R222	06S15615Y25	RES,RK 101J 1/16 -CP
MAIN-P.W.Board			R223	06S45674W73	RES,RK 472J 1/10 -CP
MAIN-P.W.Board			R224	06S45674W73	RES,RK 472J 1/10 -CP
MAIN-P.W.Board			R225	06S45674W57	RES,RK 102J 1/10 -CP
MAIN-P.W.Board		#1	R227	06S15615Y49	RES,RK 102J 1/16 -CP
MAIN-P.W.Board		#1	R228	06S15615Y49	RES,RK 102J 1/16 -CP
MAIN-P.W.Board		#1	R229	06S15615Y49	RES,RK 102J 1/16 -CP
MAIN-P.W.Board		#1	R230	06S15615Y49	RES,RK 102J 1/16 -CP

Mark Model Code
CDE-SXM145BT Only,

#1

#2 CDE-143BT Only,

\$1 CDE-143EBT Only,

\$2 CDE-143EBT(Arabia language) Only,

%1 CDE-143EBTTH Only,

&1 CDE-143CBT Only,

Others:Common.

NOTE:The part that has not PART NUMBER will not be supplied

P.W.Board	MIS	MODEL	Ref.	Parts No.	Parts Name
MAIN-P.W.Board			R231	06S15615Y48	RES,RK 911J 1/16 -CP
MAIN-P.W.Board			R232	06S15615Y48	RES,RK 911J 1/16 -CP
MAIN-P.W.Board			R233	06S15615Y48	RES,RK 911J 1/16 -CP
MAIN-P.W.Board		#1	R301	06S70072F61	RES,CP .222-J-1/4-CP
MAIN-P.W.Board		#2	R301	06S70072F61	RES,CP .222-J-1/4-CP
MAIN-P.W.Board			R304	06S45674W81	RES,RK 103J 1/10 -CP
MAIN-P.W.Board		#1	R305	06S70072F77	RES,CP .103-J-1/4-CP
MAIN-P.W.Board		#2	R305	06S70072F77	RES,CP .103-J-1/4-CP
MAIN-P.W.Board			R306	06S15615Y37	RES,RK 331J 1/16 -CP
MAIN-P.W.Board			R307	06S15615Y37	RES,RK 331J 1/16 -CP
MAIN-P.W.Board			R308	06S15593Y71	RES,RK 822F 1/10 -CP
MAIN-P.W.Board			R309	06S15593Y71	RES,RK 822F 1/10 -CP
MAIN-P.W.Board			R316	06S15593Y71	RES,RK 822F 1/10 -CP
MAIN-P.W.Board			R317	06S15593Y71	RES,RK 822F 1/10 -CP
MAIN-P.W.Board			R319	06S55366Y10	RES,RK 683J 1/10 -CP
MAIN-P.W.Board			R320	06S55366Y10	RES,RK 683J 1/10 -CP
MAIN-P.W.Board			R321	06S55366Y10	RES,RK 683J 1/10 -CP
MAIN-P.W.Board			R322	06S55366Y10	RES,RK 683J 1/10 -CP
MAIN-P.W.Board			R331	06S55363Y49	RES,RK 221J 1/8 -CP
MAIN-P.W.Board			R332	06S55363Y49	RES,RK 221J 1/8 -CP
MAIN-P.W.Board			R333	06S55363Y49	RES,RK 221J 1/8 -CP
MAIN-P.W.Board			R335	06S55363Y49	RES,RK 221J 1/8 -CP
MAIN-P.W.Board			R337	06S55363Y41	RES,RK 101J 1/8 -CP
MAIN-P.W.Board			R339	06S55363Y41	RES,RK 101J 1/8 -CP
MAIN-P.W.Board			R340	06S55363Y41	RES,RK 101J 1/8 -CP
MAIN-P.W.Board			R342	06S55363Y41	RES,RK 101J 1/8 -CP
MAIN-P.W.Board			R344	06S15615Y73	RES,RK 103J 1/16 -CP
MAIN-P.W.Board			R345	06S45674W41	RES,RK 221J 1/10 -CP
MAIN-P.W.Board			R346	06S15615Y77	RES,RK 153J 1/16 -CP
MAIN-P.W.Board			R347	06S15615Y73	RES,RK 103J 1/16 -CP
MAIN-P.W.Board			R348	06S15615Y25	RES,RK 101J 1/16 -CP
MAIN-P.W.Board			R349	06S15615Y69	RES,RK 682J 1/16 -CP
MAIN-P.W.Board			R350	06S70072F29	RES,CP .101-J-1/4-CP
MAIN-P.W.Board			R351	06S15615Y25	RES,RK 101J 1/16 -CP
MAIN-P.W.Board			R500	06S45675W43	RES,RK JUMPER1/10-CP
MAIN-P.W.Board			R503	06S45674W57	RES,RK 102J 1/10 -CP
MAIN-P.W.Board			R504	06S45674W81	RES,RK 103J 1/10 -CP
MAIN-P.W.Board			R505	06S70072F53	RES,CP .102-J-1/4-CP

Mark Model Code
CDE-SXM145BT Only,

#1

#2 CDE-143BT Only,

\$1 CDE-143EBT Only,

\$2 CDE-143EBT(Arabia language) Only,

%1 CDE-143EBTTH Only,

&1 CDE-143CBT Only,

Others:Common.

NOTE:The part that has not PART NUMBER will not be supplied

P.W.Board	MIS	MODEL	Ref.	Parts No.	Parts Name
MAIN-P.W.Board			R506	06S15593Y73	RES,RK 103F 1/10 -CP
MAIN-P.W.Board			R507	06S45674W57	RES,RK 102J 1/10 -CP
MAIN-P.W.Board			R508	06S15615Y73	RES,RK 103J 1/16 -CP
MAIN-P.W.Board			R509	06S15593Y73	RES,RK 103F 1/10 -CP
MAIN-P.W.Board			R510	06S45674W57	RES,RK 102J 1/10 -CP
MAIN-P.W.Board			R511	06S45674W57	RES,RK 102J 1/10 -CP
MAIN-P.W.Board			R512	06S45674W57	RES,RK 102J 1/10 -CP
MAIN-P.W.Board			R513	06S45674W57	RES,RK 102J 1/10 -CP
MAIN-P.W.Board			R514	06S45674W57	RES,RK 102J 1/10 -CP
MAIN-P.W.Board			R515	06S15594Y23	RES,RK JUMPER1/10-CP
MAIN-P.W.Board			R516	06S45674W89	RES,RK 223J 1/10 -CP
MAIN-P.W.Board			R517	06S45674W57	RES,RK 102J 1/10 -CP
MAIN-P.W.Board			R518	06S15594Y23	RES,RK JUMPER1/10-CP
MAIN-P.W.Board			R519	06S45674W57	RES,RK 102J 1/10 -CP
MAIN-P.W.Board			R520	06S15594Y23	RES,RK JUMPER1/10-CP
MAIN-P.W.Board			R521	06S45674W89	RES,RK 223J 1/10 -CP
MAIN-P.W.Board			R522	06S15615Y89	RES,RK 473J 1/16 -CP
MAIN-P.W.Board			R524	06S15615Y33	RES,RK 221J 1/16 -CP
MAIN-P.W.Board			R525	06S15615Y49	RES,RK 102J 1/16 -CP
MAIN-P.W.Board			R526	06S15616Y23	RES,RK JUMPER1/16-CP
MAIN-P.W.Board			R527	06S15616Y23	RES,RK JUMPER1/16-CP
MAIN-P.W.Board			R528	06S15616Y23	RES,RK JUMPER1/16-CP
MAIN-P.W.Board			R529	06S15616Y23	RES,RK JUMPER1/16-CP
MAIN-P.W.Board			R530	06S15616Y23	RES,RK JUMPER1/16-CP
MAIN-P.W.Board			R531	06S15616Y23	RES,RK JUMPER1/16-CP
MAIN-P.W.Board			R532	06S15616Y23	RES,RK JUMPER1/16-CP
MAIN-P.W.Board			R533	06S15615Y77	RES,RK 153J 1/16 -CP
MAIN-P.W.Board			R534	06S15615Y77	RES,RK 153J 1/16 -CP
MAIN-P.W.Board			R539	06S45674W89	RES,RK 223J 1/10 -CP
MAIN-P.W.Board			R540	06S15615Y89	RES,RK 473J 1/16 -CP
MAIN-P.W.Board			R541	06S15615Y81	RES,RK 223J 1/16 -CP
MAIN-P.W.Board			R542	06S15616Y23	RES,RK JUMPER1/16-CP
MAIN-P.W.Board			R543	06S45674W89	RES,RK 223J 1/10 -CP
MAIN-P.W.Board			R544	06S15615Y89	RES,RK 473J 1/16 -CP
MAIN-P.W.Board			R545	06S15615Y33	RES,RK 221J 1/16 -CP
MAIN-P.W.Board			R546	06S45675W43	RES,RK JUMPER1/10-CP
MAIN-P.W.Board			R547	06S15615Y33	RES,RK 221J 1/16 -CP
MAIN-P.W.Board			R548	06S15615Y33	RES,RK 221J 1/16 -CP

Mark Model Code
CDE-SXM145BT Only,

#1

#2 CDE-143BT Only,

\$1 CDE-143EBT Only,

\$2 CDE-143EBT(Arabia language) Only,

%1 CDE-143EBTTH Only,

&1 CDE-143CBT Only,

Others:Common.

NOTE:The part that has not PART NUMBER will not be supplied

P.W.Board	MIS	MODEL	Ref.	Parts No.	Parts Name
MAIN-P.W.Board			R549	06S15615Y25	RES,RK 101J 1/16 -CP
MAIN-P.W.Board			R550	06S15615Y89	RES,RK 473J 1/16 -CP
MAIN-P.W.Board			R551	06S15615Y25	RES,RK 101J 1/16 -CP
MAIN-P.W.Board			R552	06S15615Y33	RES,RK 221J 1/16 -CP
MAIN-P.W.Board			R553	06S15615Y33	RES,RK 221J 1/16 -CP
MAIN-P.W.Board			R554	06S15615Y25	RES,RK 101J 1/16 -CP
MAIN-P.W.Board			R555	06S15615Y49	RES,RK 102J 1/16 -CP
MAIN-P.W.Board			R556	06S15615Y25	RES,RK 101J 1/16 -CP
MAIN-P.W.Board			R557	06S15615Y25	RES,RK 101J 1/16 -CP
MAIN-P.W.Board			R558	06S45674W81	RES,RK 103J 1/10 -CP
MAIN-P.W.Board			R559	06S15615Y25	RES,RK 101J 1/16 -CP
MAIN-P.W.Board			R560	06S15615Y25	RES,RK 101J 1/16 -CP
MAIN-P.W.Board			R561	06S15615Y25	RES,RK 101J 1/16 -CP
MAIN-P.W.Board			R562	06S45674W81	RES,RK 103J 1/10 -CP
MAIN-P.W.Board			R564	06S15615Y25	RES,RK 101J 1/16 -CP
MAIN-P.W.Board			R568	06S45674W81	RES,RK 103J 1/10 -CP
MAIN-P.W.Board			R569	06S45674W81	RES,RK 103J 1/10 -CP
MAIN-P.W.Board			R570	06S15615Y25	RES,RK 101J 1/16 -CP
MAIN-P.W.Board			R571	06S15615Y25	RES,RK 101J 1/16 -CP
MAIN-P.W.Board			R572	06S45674W81	RES,RK 103J 1/10 -CP
MAIN-P.W.Board			R573	06S45674W81	RES,RK 103J 1/10 -CP
MAIN-P.W.Board			R574	06S55362Y38	RES,RK 105J 1/4 -CP
MAIN-P.W.Board			R575	06S15615Y25	RES,RK 101J 1/16 -CP
MAIN-P.W.Board			R576	06S15615Y25	RES,RK 101J 1/16 -CP
MAIN-P.W.Board			R577	06S15615Y59	RES,RK 272J 1/16 -CP
MAIN-P.W.Board			R578	06S15615Y59	RES,RK 272J 1/16 -CP
MAIN-P.W.Board			R579	06S15615Y25	RES,RK 101J 1/16 -CP
MAIN-P.W.Board			R580	06S15615Y25	RES,RK 101J 1/16 -CP
MAIN-P.W.Board			R581	06S15615Y59	RES,RK 272J 1/16 -CP
MAIN-P.W.Board			R582	06S15615Y59	RES,RK 272J 1/16 -CP
MAIN-P.W.Board			R583	06S15615Y73	RES,RK 103J 1/16 -CP
MAIN-P.W.Board			R584	06S15615Y25	RES,RK 101J 1/16 -CP
MAIN-P.W.Board			R585	06S15615Y25	RES,RK 101J 1/16 -CP
MAIN-P.W.Board			R586	06S15615Y73	RES,RK 103J 1/16 -CP
MAIN-P.W.Board			R587	06S15615Y73	RES,RK 103J 1/16 -CP
MAIN-P.W.Board			R588	06S15615Y73	RES,RK 103J 1/16 -CP
MAIN-P.W.Board			R589	06S45675W43	RES,RK JUMPER1/10-CP
MAIN-P.W.Board			R591	06S15593Y49	RES,RK 102F 1/10 -CP

Mark Model Code
CDE-SXM145BT Only,

#1

#2 CDE-143BT Only,

\$1 CDE-143EBT Only,

\$2 CDE-143EBT(Arabia language) Only,

%1 CDE-143EBTTH Only,

&1 CDE-143CBT Only,

Others:Common.

NOTE:The part that has not PART NUMBER will not be supplied

P.W.Board	MIS	MODEL	Ref.	Parts No.	Parts Name
MAIN-P.W.Board			R592	06S15593Y41	RES,RK 471F 1/10 -CP
MAIN-P.W.Board		#2	R593	06S45674W81	RES,RK 103J 1/10 -CP
MAIN-P.W.Board		\$1	R593	06S45674W81	RES,RK 103J 1/10 -CP
MAIN-P.W.Board		\$2	R593	06S45674W81	RES,RK 103J 1/10 -CP
MAIN-P.W.Board		%1	R593	06S45674W81	RES,RK 103J 1/10 -CP
MAIN-P.W.Board		&1	R593	06S45674W81	RES,RK 103J 1/10 -CP
MAIN-P.W.Board		#2	R594	06S45674W81	RES,RK 103J 1/10 -CP
MAIN-P.W.Board		#1	R595	06S45674W81	RES,RK 103J 1/10 -CP
MAIN-P.W.Board		\$1	R595	06S45674W81	RES,RK 103J 1/10 -CP
MAIN-P.W.Board		\$2	R595	06S45674W81	RES,RK 103J 1/10 -CP
MAIN-P.W.Board		%1	R595	06S45674W81	RES,RK 103J 1/10 -CP
MAIN-P.W.Board		&1	R595	06S45674W81	RES,RK 103J 1/10 -CP
MAIN-P.W.Board		#1	R596	06S45674W81	RES,RK 103J 1/10 -CP
MAIN-P.W.Board			R597	06S15615Y81	RES,RK 223J 1/16 -CP
MAIN-P.W.Board			R598	06S15615Y81	RES,RK 223J 1/16 -CP
MAIN-P.W.Board			R599	06S15615Y25	RES,RK 101J 1/16 -CP
MAIN-P.W.Board			R600	06S15615Y89	RES,RK 473J 1/16 -CP
MAIN-P.W.Board			R601	06S15615Y25	RES,RK 101J 1/16 -CP
MAIN-P.W.Board			R602	06S15615Y89	RES,RK 473J 1/16 -CP
MAIN-P.W.Board			R603	06S15615Y89	RES,RK 473J 1/16 -CP
MAIN-P.W.Board			R604	06S15615Y49	RES,RK 102J 1/16 -CP
MAIN-P.W.Board			R605	06S55362Y38	RES,RK 105J 1/4 -CP
MAIN-P.W.Board			R606	06S15616Y23	RES,RK JUMPER1/16-CP
MAIN-P.W.Board			R607	06S15616Y23	RES,RK JUMPER1/16-CP
MAIN-P.W.Board			R608	06S15616Y23	RES,RK JUMPER1/16-CP
MAIN-P.W.Board			R610	06S15615Y73	RES,RK 103J 1/16 -CP
MAIN-P.W.Board			R611	06S15615Y73	RES,RK 103J 1/16 -CP
MAIN-P.W.Board			R612	06S15615Y25	RES,RK 101J 1/16 -CP
MAIN-P.W.Board			R613	06S15615Y25	RES,RK 101J 1/16 -CP
MAIN-P.W.Board			R614	06S15615Y73	RES,RK 103J 1/16 -CP
MAIN-P.W.Board			R619	06S15615Y25	RES,RK 101J 1/16 -CP
MAIN-P.W.Board			R620	06S45675W43	RES,RK JUMPER1/10-CP
MAIN-P.W.Board			R621	06S45675W43	RES,RK JUMPER1/10-CP
MAIN-P.W.Board			R622	06S15616Y23	RES,RK JUMPER1/16-CP
MAIN-P.W.Board			R623	06S15616Y23	RES,RK JUMPER1/16-CP
MAIN-P.W.Board			R624	06S45675W43	RES,RK JUMPER1/10-CP
MAIN-P.W.Board			R625	06S45675W43	RES,RK JUMPER1/10-CP
MAIN-P.W.Board			R626	06S45675W43	RES,RK JUMPER1/10-CP

Mark Model Code
CDE-SXM145BT Only,

#1

#2 CDE-143BT Only,

\$1 CDE-143EBT Only,

\$2 CDE-143EBT(Arabia language) Only,

%1 CDE-143EBTTH Only,

&1 CDE-143CBT Only,

Others:Common.

NOTE:The part that has not PART NUMBER will not be supplied

P.W.Board	MIS	MODEL	Ref.	Parts No.	Parts Name
MAIN-P.W.Board			R627	06S45675W43	RES,RK JUMPER1/10-CP
MAIN-P.W.Board			R628	06S15615Y73	RES,RK 103J 1/16 -CP
MAIN-P.W.Board			R629	06S15615Y73	RES,RK 103J 1/16 -CP
MAIN-P.W.Board			R630	06S45674W41	RES,RK 221J 1/10 -CP
MAIN-P.W.Board			R631	06S15615Y25	RES,RK 101J 1/16 -CP
MAIN-P.W.Board			R632	06S15615Y25	RES,RK 101J 1/16 -CP
MAIN-P.W.Board			R633	06S15615Y25	RES,RK 101J 1/16 -CP
MAIN-P.W.Board			R634	06S15616Y23	RES,RK JUMPER1/16-CP
MAIN-P.W.Board			R635	06S15616Y23	RES,RK JUMPER1/16-CP
MAIN-P.W.Board			R636	06S15615Y33	RES,RK 221J 1/16 -CP
MAIN-P.W.Board			R637	06S15616Y23	RES,RK JUMPER1/16-CP
MAIN-P.W.Board			R638	06S15615Y33	RES,RK 221J 1/16 -CP
MAIN-P.W.Board			R639	06S15615Y33	RES,RK 221J 1/16 -CP
MAIN-P.W.Board			R640	06S15616Y23	RES,RK JUMPER1/16-CP
MAIN-P.W.Board			R642	06S15616Y23	RES,RK JUMPER1/16-CP
MAIN-P.W.Board			R643	06S15615Y97	RES,RK 104J 1/16 -CP
MAIN-P.W.Board			R644	06S15615Y25	RES,RK 101J 1/16 -CP
MAIN-P.W.Board			R645	06S15615Y25	RES,RK 101J 1/16 -CP
MAIN-P.W.Board			R646	06S70072F53	RES,CP .102-J-1/4-CP
MAIN-P.W.Board			R647	06S15615Y25	RES,RK 101J 1/16 -CP
MAIN-P.W.Board			R648	06S15615Y25	RES,RK 101J 1/16 -CP
MAIN-P.W.Board			R649	06S15615Y25	RES,RK 101J 1/16 -CP
MAIN-P.W.Board			R650	06S15615Y25	RES,RK 101J 1/16 -CP
MAIN-P.W.Board			R651	06S15615Y25	RES,RK 101J 1/16 -CP
MAIN-P.W.Board			R652	06S15615Y25	RES,RK 101J 1/16 -CP
MAIN-P.W.Board			R653	06S15615Y25	RES,RK 101J 1/16 -CP
MAIN-P.W.Board			R654	06S15616Y23	RES,RK JUMPER1/16-CP
MAIN-P.W.Board			R655	06S15616Y23	RES,RK JUMPER1/16-CP
MAIN-P.W.Board			R701	06S45674W73	RES,RK 472J 1/10 -CP
MAIN-P.W.Board			R702	06S70072F39	RES,CP .271-J-1/4-CP
MAIN-P.W.Board			R703	06S15615Y89	RES,RK 473J 1/16 -CP
MAIN-P.W.Board			R704	06S15615Y89	RES,RK 473J 1/16 -CP
MAIN-P.W.Board			R706	06S45675W30	RES,RK 105J 1/10 -CP
MAIN-P.W.Board			R707	06S45674W41	RES,RK 221J 1/10 -CP
MAIN-P.W.Board			R708	06S15615Y89	RES,RK 473J 1/16 -CP
MAIN-P.W.Board			R709	06S15615Y89	RES,RK 473J 1/16 -CP
MAIN-P.W.Board			R710	06S15616Y18	RES,RK 684J 1/16 -CP
MAIN-P.W.Board			R711	06S15615Y77	RES,RK 153J 1/16 -CP

Mark Model Code
CDE-SXM145BT Only,

#1

#2 CDE-143BT Only,

\$1 CDE-143EBT Only,

\$2 CDE-143EBT(Arabia language) Only,

%1 CDE-143EBTTH Only,

&1 CDE-143CBT Only,

Others:Common.

NOTE:The part that has not PART NUMBER will not be supplied

P.W.Board	MIS	MODEL	Ref.	Parts No.	Parts Name
MAIN-P.W.Board			R712	06S15615Y89	RES,RK 473J 1/16 -CP
MAIN-P.W.Board			R713	06S15615Y83	RES,RK 273J 1/16 -CP
MAIN-P.W.Board			R714	06S45674W61	RES,RK 152J 1/10 -CP
MAIN-P.W.Board			R715	06S15615Y25	RES,RK 101J 1/16 -CP
MAIN-P.W.Board			R716	06S15615Y91	RES,RK 563J 1/16 -CP
MAIN-P.W.Board			R718	06S15615Y63	RES,RK 392J 1/16 -CP
MAIN-P.W.Board			R719	06S15615Y25	RES,RK 101J 1/16 -CP
MAIN-P.W.Board			R720	06S15615Y91	RES,RK 563J 1/16 -CP
MAIN-P.W.Board			R721	06S15615Y85	RES,RK 333J 1/16 -CP
MAIN-P.W.Board			R730	06S70072F90	RES,CP .1R0-J-1/4-CP
MAIN-P.W.Board			R732	06S15615Y73	RES,RK 103J 1/16 -CP
MAIN-P.W.Board			R733	06S15615Y89	RES,RK 473J 1/16 -CP
MAIN-P.W.Board			R734	06S15615Y72	RES,RK 912J 1/16 -CP
MAIN-P.W.Board			R735	06S15615Y72	RES,RK 912J 1/16 -CP
MAIN-P.W.Board			R736	06S15615Y72	RES,RK 912J 1/16 -CP
MAIN-P.W.Board			R737	06S15615Y73	RES,RK 103J 1/16 -CP
MAIN-P.W.Board			R738	06S15616Y23	RES,RK JUMPER1/16-CP
MAIN-P.W.Board			R739	06S15616Y36	RES,RK 225J 1/16 -CP
MAIN-P.W.Board			R800	06S45674W81	RES,RK 103J 1/10 -CP
MAIN-P.W.Board			R801	06S45674W81	RES,RK 103J 1/10 -CP
MAIN-P.W.Board			R802	06S15593Y90	RES,RK 513F 1/10 -CP
MAIN-P.W.Board			R803	06-12372Z02	RES,RK R015F 1/5 -CP
MAIN-P.W.Board			R805	06S15616Y06	RES,RK 224J 1/16 -CP
MAIN-P.W.Board			R806	06S15593Y76	RES,RK 133F 1/10 -CP
MAIN-P.W.Board			R807	06S45674W81	RES,RK 103J 1/10 -CP
MAIN-P.W.Board			R809	06S45675W06	RES,RK 104J 1/10 -CP
MAIN-P.W.Board			R811	06S65415Y51	RES,RK 154F 1/16 -CP
MAIN-P.W.Board			R813	06S70072F37	RES,CP .221-J-1/4-CP
MAIN-P.W.Board			R814	06S15615Y89	RES,RK 473J 1/16 -CP
MAIN-P.W.Board			R815	06S65415Y47	RES,RK 683F 1/16 -CP
MAIN-P.W.Board			R816	06S70072F37	RES,CP .221-J-1/4-CP
MAIN-P.W.Board			R818	06S65415Y34	RES,RK 562F 1/16 -CP
MAIN-P.W.Board			R819	06S65415Y43	RES,RK 333F 1/16 -CP
MAIN-P.W.Board			R820	06S65415Y43	RES,RK 333F 1/16 -CP
MAIN-P.W.Board			R821	06S70072F77	RES,CP .103-J-1/4-CP
MAIN-P.W.Board			R822	06S35095Y01	RES,RK 333J 1/4 -CP
MAIN-P.W.Board			R825	06S15593Y77	RES,RK 153F 1/10 -CP
MAIN-P.W.Board			R828	06S15615Y25	RES,RK 101J 1/16 -CP

Mark Model Code
CDE-SXM145BT Only,

#1

#2 CDE-143BT Only,

\$1 CDE-143EBT Only,

\$2 CDE-143EBT(Arabia language) Only,

%1 CDE-143EBTTH Only,

&1 CDE-143CBT Only,

Others:Common.

NOTE:The part that has not PART NUMBER will not be supplied

P.W.Board	MIS	MODEL	Ref.	Parts No.	Parts Name
MAIN-P.W.Board			R830	06S45675W06	RES,RK 104J 1/10 -CP
MAIN-P.W.Board			R831	06S15615Y57	RES,RK 222J 1/16 -CP
MAIN-P.W.Board			R832	06S15615Y81	RES,RK 223J 1/16 -CP
MAIN-P.W.Board			R833	06S15615Y89	RES,RK 473J 1/16 -CP
MAIN-P.W.Board			R834	06S70072F77	RES,CP .103-J-1/4-CP
MAIN-P.W.Board			R835	06S45675W43	RES,RK JUMPER1/10-CP
MAIN-P.W.Board			R838	06S45675W43	RES,RK JUMPER1/10-CP
MAIN-P.W.Board			R839	06S15615Y37	RES,RK 331J 1/16 -CP
MAIN-P.W.Board			R840	06-12372Z02	RES,RK R015F 1/5 -CP
MAIN-P.W.Board			R842	06S15616Y23	RES,RK JUMPER1/16-CP
MAIN-P.W.Board			R843	06S15615Y49	RES,RK 102J 1/16 -CP
MAIN-P.W.Board			R844	06S15616Y23	RES,RK JUMPER1/16-CP
MAIN-P.W.Board			R845	06S35083Y34	RES,RK 562F 1/4 -CP
MAIN-P.W.Board			R854	06S15615Y25	RES,RK 101J 1/16 -CP
MAIN-P.W.Board			R857	06S45674W89	RES,RK 223J 1/10 -CP
MAIN-P.W.Board			R858	06S15615Y57	RES,RK 222J 1/16 -CP
MAIN-P.W.Board			R859	06S45675W06	RES,RK 104J 1/10 -CP
MAIN-P.W.Board		#1	R900	06S35095Y08	RES,RK JUMPER 1/4-CP
MAIN-P.W.Board		#2	R900	06S35095Y08	RES,RK JUMPER 1/4-CP
MAIN-P.W.Board			R901	06S15615Y73	RES,RK 103J 1/16 -CP
MAIN-P.W.Board			R902	06S15615Y73	RES,RK 103J 1/16 -CP
MAIN-P.W.Board			R903	06S15615Y25	RES,RK 101J 1/16 -CP
MAIN-P.W.Board			R904	06S15615Y49	RES,RK 102J 1/16 -CP
MAIN-P.W.Board			R905	06S15615Y25	RES,RK 101J 1/16 -CP
MAIN-P.W.Board			R906	06S45675W43	RES,RK JUMPER1/10-CP
MAIN-P.W.Board			R907	06S15615Y25	RES,RK 101J 1/16 -CP
MAIN-P.W.Board			R908	06S15615Y49	RES,RK 102J 1/16 -CP
MAIN-P.W.Board			R909	06S65415Y11	RES,RK 68RF 1/16 -CP
MAIN-P.W.Board			R911	06S45675W30	RES,RK 105J 1/10 -CP
MAIN-P.W.Board			R912	06S45674W89	RES,RK 223J 1/10 -CP
MAIN-P.W.Board		#1	R913	06S70072F29	RES,CP .101-J-1/4-CP
MAIN-P.W.Board		#2	R913	06S70072F29	RES,CP .101-J-1/4-CP
MAIN-P.W.Board		#1	R914	06S15615Y57	RES,RK 222J 1/16 -CP
MAIN-P.W.Board		#2	R914	06S15615Y57	RES,RK 222J 1/16 -CP
MAIN-P.W.Board		#1	R915	06S45674W69	RES,RK 332J 1/10 -CP
MAIN-P.W.Board		#2	R915	06S45674W69	RES,RK 332J 1/10 -CP
MAIN-P.W.Board			R916	06S45674W89	RES,RK 223J 1/10 -CP
MAIN-P.W.Board			R917	06S45674W57	RES,RK 102J 1/10 -CP

Mark Model Code
CDE-SXM145BT Only,

#1

#2 CDE-143BT Only,

\$1 CDE-143EBT Only,



\$2 CDE-143EBT(Arabia language) Only,

%1 CDE-143EBTTH Only,

&1 CDE-143CBT Only,

Others:Common.

NOTE:The part that has not PART NUMBER will not be supplied

P.W.Board	MIS	MODEL	Ref.	Parts No.	Parts Name
MAIN-P.W.Board			R919	06S45674W97	RES,RK 473J 1/10 -CP
MAIN-P.W.Board		#1	R920	06S45674W97	RES,RK 473J 1/10 -CP
MAIN-P.W.Board		#1	R921	06S45674W97	RES,RK 473J 1/10 -CP
MAIN-P.W.Board		#1	R922	06S70072F53	RES,CP .102-J-1/4-CP
MAIN-P.W.Board		#1	R923	06S70072F53	RES,CP .102-J-1/4-CP
MAIN-P.W.Board		#1	R924	06S45674W97	RES,RK 473J 1/10 -CP
MAIN-P.W.Board		#1	R925	06S70072F53	RES,CP .102-J-1/4-CP
MAIN-P.W.Board		#1	R926	06S35095Y08	RES,RK JUMPER 1/4-CP
MAIN-P.W.Board		#1	R927	06S35095Y08	RES,RK JUMPER 1/4-CP
MAIN-P.W.Board		#1	R928	06S35095Y08	RES,RK JUMPER 1/4-CP
MAIN-P.W.Board		\$1	R929	06S35095Y08	RES,RK JUMPER 1/4-CP
MAIN-P.W.Board		\$2	R929	06S35095Y08	RES,RK JUMPER 1/4-CP
MAIN-P.W.Board		%1	R929	06S35095Y08	RES,RK JUMPER 1/4-CP
MAIN-P.W.Board		&1	R929	06S35095Y08	RES,RK JUMPER 1/4-CP
MAIN-P.W.Board		\$1	R930	06S35095Y08	RES,RK JUMPER 1/4-CP
MAIN-P.W.Board		\$2	R930	06S35095Y08	RES,RK JUMPER 1/4-CP
MAIN-P.W.Board		%1	R930	06S35095Y08	RES,RK JUMPER 1/4-CP
MAIN-P.W.Board		&1	R930	06S35095Y08	RES,RK JUMPER 1/4-CP
MAIN-P.W.Board			R933	06S45674W65	RES,RK 222J 1/10 -CP
MAIN-P.W.Board			R934	06S45674W89	RES,RK 223J 1/10 -CP
MAIN-P.W.Board		#1	R935	06S35095Y08	RES,RK JUMPER 1/4-CP
MAIN-P.W.Board		#2	R935	06S35095Y08	RES,RK JUMPER 1/4-CP
MAIN-P.W.Board			RA501	06S15771Y13	RES,ARYEXB28V101J-CP
MAIN-P.W.Board		#1	RA502	06S15771Y13	RES,ARYEXB28V101J-CP
MAIN-P.W.Board			RA503	06S15771Y13	RES,ARYEXB28V101J-CP
MAIN-P.W.Board			RA701	06S15771Y33	RES,ARY 472J 4 -CP
MAIN-P.W.Board			RA702	06S15771Y33	RES,ARY 472J 4 -CP
MAIN-P.W.Board			RA703	06S15771Y13	RES,ARYEXB28V101J-CP
MAIN-P.W.Board			RA704	06S15771Y13	RES,ARYEXB28V101J-CP
MAIN-P.W.Board			RA705	06S15771Y13	RES,ARYEXB28V101J-CP
MAIN-P.W.Board			RA706	06S15771Y13	RES,ARYEXB28V101J-CP
MAIN-P.W.Board			RA707	06S15771Y45	RES,ARYEXB28V473J-CP
MAIN-P.W.Board			RA708	06S15771Y45	RES,ARYEXB28V473J-CP
MAIN-P.W.Board			SA101	48-00954Z03	VST,CSA30-401Q-T -CP
MAIN-P.W.Board			SD801	48T45286Y01	DIO,SHT RB050L-40-E1
MAIN-P.W.Board			SF601	91-25003Z01	SAW,B39242B3912U -E1
MAIN-P.W.Board			SW501	40T16096W03	SW ,TACT SKHHLW
MAIN-P.W.Board			T301	25-25218Z01	ASSY,A039A0001 -DB

Mark Model Code
CDE-SXM145BT Only,

#1

#2 CDE-143BT Only,

\$1 CDE-143EBT Only,









\$2 CDE-143EBT(Arabia language) Only,

%1 CDE-143EBTTH Only,

&1 CDE-143CBT Only,

Others:Common.

NOTE:The part that has not PART NUMBER will not be supplied

P.W.Board	MIS	MODEL	Ref.	Parts No.	Parts Name
MAIN-P.W.Board			VR801	18-12468Z11	VAR,EVM2NSX80 224-CP
MAIN-P.W.Board			VT101	24-03457Z02	COIL,RF FM 5CCE -E6
MAIN-P.W.Board			XL101	91-24701Z03	XTL,DSX321G 62.40-CP
MAIN-P.W.Board			XL502	91-24701Z02	XTL,DSX321G 12.00-CP
MAIN-P.W.Board			XL601	91-17642Z25	XTL,NX3225SA 26NS-CP
MAIN-P.W.Board			XL701	91-24701Z01	XTL,DSX321G 16.93-CP
MAIN-P.W.Board			Z502	91T15509Y08	EMI,BK1608HM102 -CP
MAIN-P.W.Board			Z701	91T75196Y08	EMI,BK1005HW601 -CP
MAIN-P.W.Board			ZD501	48-18196Z02	DIO,ZEN DZ2S051M0LCP
MAIN-P.W.Board			ZD502	48-18196Z02	DIO,ZEN DZ2S051M0LCP
MAIN-P.W.Board			ZD503	48-21149Z19	DIO,ZEN DZ2J051L0LCP
MAIN-P.W.Board		#1	ZD901	48-21149Z23	DIO,ZEN DZ2J056M0LCP
MAIN-P.W.Board		#1	ZD902	48-21149Z23	DIO,ZEN DZ2J056M0LCP
MAIN-P.W.Board		#1	ZD903	48-21149Z23	DIO,ZEN DZ2J056M0LCP
FRONT-P.W.Board			C403	08S45676W65	CAP,CER.222K-B1H -CP
FRONT-P.W.Board			C408	08S35349Y12	CAP,CER 105K-B0J -CP
FRONT-P.W.Board			C409	08S35349Y12	CAP,CER 105K-B0J -CP
FRONT-P.W.Board			C410	08S65667Y03	CAP,CER 474KX5R1A-CP
FRONT-P.W.Board			C411	08S35374W12	CAP,CER 106K-B0J -CP
FRONT-P.W.Board			C413	08S45676W65	CAP,CER.222K-B1H -CP
FRONT-P.W.Board			CB401	09-18716Z01	BTB,DF20-P -EJ
FRONT-P.W.Board			D401	48-12230Z01	DIO,KDS226-RTK -CP
FRONT-P.W.Board			D402	48-12230Z01	DIO,KDS226-RTK -CP
FRONT-P.W.Board			D403	48-12230Z01	DIO,KDS226-RTK -CP
FRONT-P.W.Board			D406	48-12230Z01	DIO,KDS226-RTK -CP
FRONT-P.W.Board			D407	48-07015Z01	DIO,KDS160-RTK -CP
FRONT-P.W.Board			IC401	51-17831Z01	BU97500KV-E2 -QEA
FRONT-P.W.Board			IC402	51-18623Z01	PNJ4L02M -NE1
FRONT-P.W.Board			JK401	09-18872Z01	JAC,1850383000322-DB
FRONT-P.W.Board		#1	LCD401	65-23891Z02	LCD,EH0562M0TTNJ-FZ
FRONT-P.W.Board		#2	LCD401	65-23891Z01	LCD,EH0052M0TTNJ-FZ
FRONT-P.W.Board		\$1	LCD401	65-23891Z01	LCD,EH0052M0TTNJ-FZ
FRONT-P.W.Board		\$2	LCD401	65-23891Z01	LCD,EH0052M0TTNJ-FZ
FRONT-P.W.Board		%1	LCD401	65-23891Z01	LCD,EH0052M0TTNJ-FZ
FRONT-P.W.Board		&1	LCD401	65-23891Z01	LCD,EH0052M0TTNJ-FZ
FRONT-P.W.Board			LD401	48-24837Z01	LED,ARY MDL463-011DB
FRONT-P.W.Board			LD421	48-15702Z01	LED,BLU SCM015BC7TCP
FRONT-P.W.Board			LD422	48-15702Z01	LED,BLU SCM015BC7TCP

Mark Model Code
CDE-SXM145BT Only,

#1

#2 CDE-143BT Only,

\$1 CDE-143EBT Only,

\$2 CDE-143EBT(Arabia language) Only,

%1 CDE-143EBTTH Only,

&1 CDE-143CBT Only,

Others:Common.

NOTE:The part that has not PART NUMBER will not be supplied

P.W.Board	MIS	MODEL	Ref.	Parts No.	Parts Name
FRONT-P.W.Board			LD423	48-15702Z01	LED,BLU SCM015BC7TCP
FRONT-P.W.Board			LD424	48-15702Z01	LED,BLU SCM015BC7TCP
FRONT-P.W.Board			LD425	48-15702Z01	LED,BLU SCM015BC7TCP
FRONT-P.W.Board			LD426	48-15702Z01	LED,BLU SCM015BC7TCP
FRONT-P.W.Board			LD427	48-15702Z01	LED,BLU SCM015BC7TCP
FRONT-P.W.Board			LD428	48-15702Z01	LED,BLU SCM015BC7TCP
FRONT-P.W.Board			LD431	48-15702Z01	LED,BLU SCM015BC7TCP
FRONT-P.W.Board			LD432	48-15702Z01	LED,BLU SCM015BC7TCP
FRONT-P.W.Board			LD433	48-15702Z01	LED,BLU SCM015BC7TCP
FRONT-P.W.Board			LD434	48-15702Z01	LED,BLU SCM015BC7TCP
FRONT-P.W.Board			LD437	48-15702Z01	LED,BLU SCM015BC7TCP
FRONT-P.W.Board			LD439	48-15702Z01	LED,BLU SCM015BC7TCP
FRONT-P.W.Board			LD458	48-15702Z01	LED,BLU SCM015BC7TCP
FRONT-P.W.Board		#1	Q403	48-21758Z01	TR,DSC2001S0L -CP
FRONT-P.W.Board		#2	Q403	48-21758Z01	TR,DSC2001S0L -CP
FRONT-P.W.Board		#1	Q404	48-13059Z01	TR,KTC2875-B-RTK -CP
FRONT-P.W.Board		#2	Q404	48-13059Z01	TR,KTC2875-B-RTK -CP
FRONT-P.W.Board			Q405	48-13059Z01	TR,KTC2875-B-RTK -CP
FRONT-P.W.Board			Q409	48-04929Z07	TR,KRC107S-RTK -CP
FRONT-P.W.Board		#1	Q410	48-20092Z01	TR,DMG563010R -CP
FRONT-P.W.Board		#2	Q410	48-20092Z01	TR,DMG563010R -CP
FRONT-P.W.Board			R401	06S64995F53	RES,RK 102J 1/8 -CP
FRONT-P.W.Board			R406	06S64995F53	RES,RK 102J 1/8 -CP
FRONT-P.W.Board			R407	06S64995F53	RES,RK 102J 1/8 -CP
FRONT-P.W.Board			R408	06S70072F13	RES,CP .22R-J-1/4-CP
FRONT-P.W.Board			R409	06S64995F53	RES,RK 102J 1/8 -CP
FRONT-P.W.Board			R410	06S64995F53	RES,RK 102J 1/8 -CP
FRONT-P.W.Board			R411	06S70072F13	RES,CP .22R-J-1/4-CP
FRONT-P.W.Board			R413	06S64995F53	RES,RK 102J 1/8 -CP
FRONT-P.W.Board		#1	R418	06S70072F51	RES,CP .821-J-1/4-CP
FRONT-P.W.Board		#2	R418	06S70072F51	RES,CP .821-J-1/4-CP
FRONT-P.W.Board		\$1	R418	06S35095Y08	RES,RK JUMPER 1/4-CP
FRONT-P.W.Board		\$2	R418	06S35095Y08	RES,RK JUMPER 1/4-CP
FRONT-P.W.Board		%1	R418	06S35095Y08	RES,RK JUMPER 1/4-CP
FRONT-P.W.Board		&1	R418	06S35095Y08	RES,RK JUMPER 1/4-CP
FRONT-P.W.Board		#1	R419	06S45674W73	RES,RK 472J 1/10 -CP
FRONT-P.W.Board		#2	R419	06S45674W73	RES,RK 472J 1/10 -CP
FRONT-P.W.Board		#1	R420	06S45674W57	RES,RK 102J 1/10 -CP

Mark Model Code
CDE-SXM145BT Only,

#1

#2 CDE-143BT Only,

\$1 CDE-143EBT Only,

\$2 CDE-143EBT(Arabia language) Only,

%1 CDE-143EBTTH Only,

&1 CDE-143CBT Only,

Others:Common.

NOTE:The part that has not PART NUMBER will not be supplied

P.W.Board	MIS	MODEL	Ref.	Parts No.	Parts Name
FRONT-P.W.Board		#2	R420	06S45674W57	RES,RK 102J 1/10 -CP
FRONT-P.W.Board		#1	R421	06S70072F17	RES,CP .33R-J-1/4-CP
FRONT-P.W.Board		#2	R421	06S70072F17	RES,CP .33R-J-1/4-CP
FRONT-P.W.Board		\$1	R421	06S35095Y08	RES,RK JUMPER 1/4-CP
FRONT-P.W.Board		\$2	R421	06S35095Y08	RES,RK JUMPER 1/4-CP
FRONT-P.W.Board		%1	R421	06S35095Y08	RES,RK JUMPER 1/4-CP
FRONT-P.W.Board		&1	R421	06S35095Y08	RES,RK JUMPER 1/4-CP
FRONT-P.W.Board			R432	06S35084Y39	RES,RK 153F 1/8 -CP
FRONT-P.W.Board			R434	06S35084Y78	RES,RK 132F 1/8 -CP
FRONT-P.W.Board			R435	06S35084Y39	RES,RK 153F 1/8 -CP
FRONT-P.W.Board			R436	06S35084Y44	RES,RK 393F 1/8 -CP
FRONT-P.W.Board			R437	06S35084Y78	RES,RK 132F 1/8 -CP
FRONT-P.W.Board			R438	06S35084Y28	RES,RK 182F 1/8 -CP
FRONT-P.W.Board			R439	06S35084Y31	RES,RK 332F 1/8 -CP
FRONT-P.W.Board			R440	06S35084Y29	RES,RK 222F 1/8 -CP
FRONT-P.W.Board			R441	06S35084Y64	RES,RK 432F 1/8 -CP
FRONT-P.W.Board			R442	06S35084Y68	RES,RK 752F 1/8 -CP
FRONT-P.W.Board			R443	06S15615Y89	RES,RK 473J 1/16 -CP
FRONT-P.W.Board			R444	06S15615Y89	RES,RK 473J 1/16 -CP
FRONT-P.W.Board			R446	06S15593Y87	RES,RK 393F 1/10 -CP
FRONT-P.W.Board			R447	06S15615Y49	RES,RK 102J 1/16 -CP
FRONT-P.W.Board			R455	06S35084Y28	RES,RK 182F 1/8 -CP
FRONT-P.W.Board			R456	06S35084Y31	RES,RK 332F 1/8 -CP
FRONT-P.W.Board			R457	06S35084Y29	RES,RK 222F 1/8 -CP
FRONT-P.W.Board			R458	06S35084Y64	RES,RK 432F 1/8 -CP
FRONT-P.W.Board			R459	06S35084Y68	RES,RK 752F 1/8 -CP
FRONT-P.W.Board			R460	06S15615Y89	RES,RK 473J 1/16 -CP
FRONT-P.W.Board			R461	06S70072F29	RES,CP .101-J-1/4-CP
FRONT-P.W.Board			R462	06S70072F41	RES,CP .331-J-1/4-CP
FRONT-P.W.Board			R463	06S70072F41	RES,CP .331-J-1/4-CP
FRONT-P.W.Board			R465	06S70072F41	RES,CP .331-J-1/4-CP
FRONT-P.W.Board			R466	06S70072F63	RES,CP .272-J-1/4-CP
FRONT-P.W.Board			R467	06S70072F56	RES,CP .132-J-1/4-CP
FRONT-P.W.Board			R468	06S70072F41	RES,CP .331-J-1/4-CP
FRONT-P.W.Board			R469	06S70072F41	RES,CP .331-J-1/4-CP
FRONT-P.W.Board			R470	06S45674W58	RES,RK 112J 1/10 -CP
FRONT-P.W.Board			R471	06S70072F50	RES,CP .751-J-1/4-CP
FRONT-P.W.Board			R472	06S70072F61	RES,CP .222-J-1/4-CP

Mark Model Code
CDE-SXM145BT Only,

#1

#2 CDE-143BT Only,

\$1 CDE-143EBT Only,

\$2 CDE-143EBT(Arabia language) Only,

%1 CDE-143EBTTH Only,

&1 CDE-143CBT Only,

Others:Common.

NOTE:The part that has not PART NUMBER will not be supplied

P.W.Board	MIS	MODEL	Ref.	Parts No.	Parts Name
FRONT-P.W.Board			R482	06S70072F56	RES,CP .132-J-1/4-CP
FRONT-P.W.Board			R483	06S70072F45	RES,CP .471-J-1/4-CP
FRONT-P.W.Board			RA401	06S15771Y13	RES,ARYEXB28V101J-CP
FRONT-P.W.Board	☐		SK401	09-19382Z01	SKT,CM-V105 -DB
FRONT-P.W.Board			SW401	40T65353Y01	SW,TACT SKRSPACE010E2
FRONT-P.W.Board			SW402	40T65353Y01	SW,TACT SKRSPACE010E2
FRONT-P.W.Board			SW404	40T65353Y01	SW,TACT SKRSPACE010E2
FRONT-P.W.Board			SW405	40T65353Y01	SW,TACT SKRSPACE010E2
FRONT-P.W.Board			SW406	40T65353Y01	SW,TACT SKRSPACE010E2
FRONT-P.W.Board			SW407	40T65353Y01	SW,TACT SKRSPACE010E2
FRONT-P.W.Board			SW408	40T65353Y01	SW,TACT SKRSPACE010E2
FRONT-P.W.Board			SW409	40T65353Y01	SW,TACT SKRSPACE010E2
FRONT-P.W.Board			SW410	40T65353Y01	SW,TACT SKRSPACE010E2
FRONT-P.W.Board			SW411	40T65353Y01	SW,TACT SKRSPACE010E2
FRONT-P.W.Board	☐		SW412	40-10735Z02	ENC,EC12D1524405 -DB
FRONT-P.W.Board			SW413	40T65353Y01	SW,TACT SKRSPACE010E2
FRONT-P.W.Board			SW414	40T65353Y01	SW,TACT SKRSPACE010E2
FRONT-P.W.Board			SW415	40T65353Y01	SW,TACT SKRSPACE010E2
FRONT-P.W.Board			SW416	40T65353Y01	SW,TACT SKRSPACE010E2
FRONT-P.W.Board			SW417	40T65353Y01	SW,TACT SKRSPACE010E2
FRONT-P.W.Board			SW418	40T65353Y01	SW,TACT SKRSPACE010E2
FRONT-P.W.Board			Z401	91-14147Z01	EMI,ACM2012H-900 -CP
FRONT-P.W.Board			ZD401	48-18196Z02	DIO,ZEN DZ2S051M0LCP
FRONT-P.W.Board			ZD402	48-18196Z02	DIO,ZEN DZ2S051M0LCP
IF(DP86Z7BA)- P.W.Board			CB101	09T75287Y24	FFC,IMSA9631S-24Y-ED
IF(DP86Z7BA)- P.W.Board			PT500	48-19918Z01	PHT,TR TPS1191RB1-CP
IF(DP86Z7BA)- P.W.Board			PT502	48-19918Z01	PHT,TR TPS1191RB1-CP
IF(DP86Z7BA)- P.W.Board			R500	06S15615Y87	RES,RK 393J 1/16 -CP
IF(DP86Z7BA)- P.W.Board			R502	06S15615Y87	RES,RK 393J 1/16 -CP
SENSOR(DP86Z7BA)- P.W.Board			LD700	48-01591Z01	LED,AN1105W-1-TR -CP
SENSOR(DP86Z7BA)- P.W.Board			LD701	48-01591Z01	LED,AN1105W-1-TR -CP
SENSOR(DP86Z7BA)-			R700	06S45674W43	RES,RK 271J 1/10 -CP

Mark Model Code
CDE-SXM145BT Only,

#1

#2 CDE-143BT Only,

\$1 CDE-143EBT Only,

\$2 CDE-143EBT(Arabia language) Only,

%1 CDE-143EBTTH Only,

&1 CDE-143CBT Only,

Others:Common.

NOTE:The part that has not PART NUMBER will not be supplied

P.W.Board	MIS	MODEL	Ref.	Parts No.	Parts Name
P.W.Board					
SENSOR(DP86Z7BA)- P.W.Board			R701	06S45674W43	RES,RK 271J 1/10 -CP
DRIVE(DP86Z7BA)- P.W.Board			SW800	40T15494Y18	SW,DETCT SPVG1302-E6
Miscellaneous			HD1	EP-17785Z02	EP21A99N-M
Miscellaneous			M1	66-23978Z27	ASSY,MTR SPD L RF300
Miscellaneous			M2	66-23978Z28	ASSY,MTR SLED 2

Mark Model Code
CDE-SXM145BT Only,

#1

#2 CDE-143BT Only,

\$1 CDE-143EBT Only,

\$2 CDE-143EBT(Arabia language) Only,

%1 CDE-143EBTTH Only,

&1 CDE-143CBT Only,

Others:Common.

NOTE:The part that has not PART NUMBER will not be supplied